

**REFERENCE MANUAL
PREAMPLIFIERS
ENGLISH**

Contents

Section	Page					
		Contents				
1		Connections	E1			
1.1		Interconnect Cables	E1			
2		Mains Power	E1			
2.1		Mains Plug Wiring	E1			
2.2		Equipment Fuses	E1			
2.3		Non-rewirable Mains Plugs	E1			
2.4		Mains Circuits and Cables	E1			
3		General Installation	E2			
3.1		Siting The Equipment	E2			
3.2		Switching On	E2			
3.3		Running In	E2			
3.4		Radio Interference	E2			
3.5		Lightning Precautions	E2			
3.6		Problems?	E2			
3.7		Service and Updates	E2			
4		NAC 552 Introduction and Installation	E3			
4.1		Source Inputs and Record Outputs	E3			
4.2		Input Socket Assignment	E3			
4.3		Socket Types and Assignment Defaults	E4			
4.4		Record Mute	E4			
4.5		NAC 552 Signal Outputs	E4			
4.6		Auxiliary Power Output	E4			
5		NAC 552 Connections and Controls	E4			
5.1		NAC 552 Rear Panel Connections	E4			
5.2		NAC 552 Connected to NAC 552PS	E5			
5.3		NAC 552 Front Panel Controls	E5			
6		Specification	E5			
7		NAC 252 Introduction and Installation	E6			
7.1		Source Inputs and Record Outputs	E6			
7.2		Input Socket Assignment	E6			
7.3		Record Mute	E6			
7.4		NAC 252 Signal Outputs	E6			
7.5		Auxiliary Power Output	E6			
8		NAC 252 Connections and Controls	E7			
8.1		NAC 252 Rear Panel Connections	E7			
8.2		NAC 252 Connected to SuperCap	E7			
8.3		NAC 252 Front Panel Controls	E8			
9		Specification	E8			
10		NAC 282, NAC 202 and NAC 152 XS Introduction and Installation	E9			
10.1		NAC 282 Source Inputs and Record Outputs	E9			
10.2		NAC 282 and NAC 202 Input Socket Assignment	E9			
10.3		NAC 282 and NAC 202 Record Mute	E9			
10.4		NAC 152 XS Source Inputs	E10			
				10.5	Signal Outputs	E10
				10.6	Auxiliary Power Outputs	E10
				10.7	Power Supply Upgrades	E10
				11	NAC 282, NAC 202 and NAC 152 XS Rear Panel Connections	E11
				11.1	NAC 282 Rear Panel Sockets	E11
				11.2	NAC 202 Rear Panel Sockets	E12
				11.3	NAC 152 XS Rear Panel Sockets	E12
				12	NAC 282, NAC 202 and NAC 152 XS Power Supply Connections	E13
				12.1	NAC 282 Connected to Hi-Cap and NAPSC	E13
				12.2	NAC 282 Connected to SuperCap and NAPSC	E13
				12.3	NAC 202 Connected to Hi-Cap and NAPSC	E14
				12.4	NAC 152 XS Connected to FlatCap (both outputs)	E14
				12.5	NAC 152 XS Connected to FlatCap and Hi-Cap	E15
				12.6	NAC 282 Front Panel Controls	E15
				12.7	NAC 202 Front Panel Controls	E16
				12.8	NAC 152 XS Front Panel Controls	E16
				13	Specifications	E16
				14	Preamplifier Operation	E17
				14.1	Automatic Input Switching	E17
				14.2	AV Bypass	E17
				14.3	Handset Volume and Balance Control	E18
				14.4	Mute, Mono and Mon	E18
				14.5	Display	E18
				14.6	Switching On	E18
				14.7	Defaults	E18
				14.8	Fault Conditions	E19
				14.9	Interface Function Buttons and Keys	E19
				15	R-com Remote Handset	E20
				15.1	Using R-com	E20
				15.2	R-com Keys	E20
				16	NARCOM 4 Remote Handset	E21
				16.1	Using NARCOM 4	E21
				16.2	NARCOM 4 Keys	E21
				17	Declaration of Conformity	E22
				18	Statutory Safety Warnings	E22

Introduction

Naim Audio products are conceived with performance as the top priority. Careful installation will help ensure that their full potential is achieved. This manual covers all non-streaming preamplifiers. It begins with some general installation notes. Product specific information begins in Section 4.

Note: Please read the Statutory Safety Warnings found at the end of this manual.

1 Connections

It is important for both safety and performance that the standard cables supplied are not modified.

1.1 Interconnect Cables

If options are available with your equipment and installation, DIN interconnect sockets should be used in preference to RCA Phono sockets. One end of each Naim interconnect cable is marked with a band to establish its correct orientation. The band denotes the end that connects to the signal source. Naim Hi-Line interconnect cables will provide the best results.

Interconnect plugs and sockets should be kept clean and free from corrosion. The easiest way to clean them is to switch off the equipment, pull the plugs out of their sockets, and push them back in again. Contact cleaners and “enhancers” should not be used as the film they deposit may degrade the sound.

2 Mains Power

Where fused plugs are used 13 amp fuses should be fitted. Fuses of a lower rating will fail after a period of use. Do not wire voltage dependent resistors or noise suppressors into mains plugs. They degrade the mains supply and the sound.

2.1 Mains Plug Wiring

In some territories a mains plug may need to be fitted to the supplied mains lead. As the colours of the wires in the mains lead may not correspond with the coloured markings identifying the terminals in the plug proceed as follows:

The wire coloured **GREEN-AND-YELLOW** must be connected to the terminal in the plug marked by the letter **E** or by the safety earth symbol or coloured **GREEN** or **GREEN** and **YELLOW**.

The wire coloured **BLUE** must be connected to the terminal in the plug marked with the letter **N** or coloured **BLACK**.

The wire coloured **BROWN** must be connected to the terminal in the plug marked with the letter **L** or coloured **RED**.

2.2 Equipment Fuses

Mains powered Naim Audio equipment is fitted with a mains fuse on the rear panel adjacent to the mains input socket. Replace it if necessary only with the spare fuse supplied or with an identical fuse. Repeated failure of the fuse points to a fault that should be investigated by your retailer or Naim itself.

2.3 Non-rewirable Mains Plugs

If a non-rewirable plug is cut from a mains lead (for whatever purpose) the plug **MUST** be disposed of in a way to render it totally useless. Considerable shock hazard exists if the cut-off plug is inserted into a mains outlet.

2.4 Mains Circuits and Cables

A hi-fi system usually shares a mains circuit with other household equipment some of which can cause distortion of the mains waveform. This distortion can in turn lead to mechanical hum from mains transformers. Some Naim transformers are large in size, making them relatively sensitive to such distortion, and it may be necessary to take account of transformer hum when siting your equipment.

Transformer hum is not transmitted through the speakers and has no effect on the performance of the system; however, a separate mains circuit may reduce it. Such a circuit (ideally with a 30 or 45 Amp rating) will also generally improve system performance. Advice on the installation of a separate mains circuit should be sought from a qualified electrician.

Use only the mains leads and plugs supplied or the Naim PowerLine mains cable.

Introduction

3 General Installation

Naim equipment is designed to offer the finest performance possible avoiding compromise wherever practical. This can lead to circumstances that may be unfamiliar. The notes that follow contain advice specifically related to Naim equipment as well as more general warnings about the use of domestic audio products. Please read them carefully.

3.1 Siting The Equipment

In order to reduce the risk of hum audible from the loudspeakers, power supplies and power amplifiers should be located a reasonable distance away from other equipment. The maximum separation distance for connected equipment is that allowed by the standard interconnect lead.

Some Naim equipment is extremely heavy. Check the weight of the equipment prior to lifting and if necessary use more than one person so that it can be moved safely. Ensure that your equipment rack or table can easily support the weight and is stable.

3.2 Switching On

Source components and power supplies should be switched on before the power amplifiers. Always switch amplifiers off and wait a minute before connecting or disconnecting any leads. Always use the power switch on the product rather than a mains outlet switch.

A "thump" may be heard from the loudspeakers as power amplifiers are switched on. This is normal, will not cause any loudspeaker damage and does not point to any fault or problem. A mild "pop" may also be heard shortly after equipment is switched off.

3.3 Running In

Naim equipment takes a considerable time to run in before it performs at its best. The duration varies, but under some conditions the sound may continue to improve for over a month. Better and more consistent performance will be achieved if the system is left switched on for long periods. It is worth remembering however that equipment left connected to the mains can be damaged by lightning.

3.4 Radio Interference

In some circumstances, depending on where you live and the earthing arrangements in your home, you may experience radio frequency interference. Controls on broadcasting in some territories allow very high levels of radio frequency radiation and both the choice and exact siting of equipment may be critical. Susceptibility to radio frequency interference is related to the wide internal bandwidth necessary for high sound quality. A radio frequency filter kit is available for some Naim equipment but sound quality will be progressively compromised as more elements of the kit are fitted.

3.5 Lightning Precautions

Your Naim hi-fi system can be damaged by lightning and should be turned off and disconnected from the mains when there is risk of lightning strike. For complete protection all mains plugs and any aerial cables should be disconnected when not in use.

3.6 Problems?

Consumer protection varies from country to country. In most territories a retailer must be prepared to take back any equipment he has sold if it cannot be made to work satisfactorily. A problem may be due to a fault in the system or its installation so it is essential to make full use of your dealer's diagnostic skills. Please contact your local distributor, or Naim Audio directly, if any difficulties cannot be resolved.

Some Naim equipment is made in special versions for different territories and this makes it impracticable to arrange international guarantees. Please establish the local guarantee arrangements with your retailer. Contact Naim Audio directly for help and advice if necessary.

3.7 Service and Updates

It is essential that repairs and updates are only carried out by an authorised Naim retailer or at the factory by Naim itself. Many components are custom made, tested or matched and appropriate replacements are often unobtainable from other sources.

Direct contact to Naim for service or update information should be made initially through Customer Services:

Tel: **+44 (0)1722 426600**
Email: **info@naimaudio.com**

Please quote the product serial number (found on its rear panel) in all correspondence.

NAC 552

4 NAC 552 Introduction and Installation

The NAC 552 preamplifier does not incorporate an internal power supply and can be used only in conjunction with the NAC 552PS power supply. Diagram 5.2 illustrates connection of the NAC 552 to its power supply.

The four transit screws on the underside of the NAC 552 case should be removed before use and must be replaced if the unit is to be re-packed and shipped. These transit screws must not be used in any other Naim product. Do not invert the NAC 552 once the transit screws are removed.

The preamplifier and power supply should be installed on a dedicated equipment stand intended for the purpose. Do not stand either directly on top of another item of equipment. Care should be taken to ensure that the preamplifier is level. The units are heavy and care should be taken when lifting or moving them. Make sure that the surface on which they are to be placed can support their weight.

The preamplifier and power supply should be installed in their final locations before connecting cables or switching on. Ensure that power amplifiers are switched off and that the preamplifier volume is turned down before the power supply is switched on. The power button is located on the power supply front panel.

The following paragraphs describe installation features and functions specific to the NAC 552. Operational features common to all preamplifiers are described in Section 14.

Both R-Com and NARCOM 4 remote handsets are included with the NAC 552. The R-com is intended for day-to-day use while the NARCOM 4 can be used for handset-based setup and programming.

Operational features common to all preamplifiers are described in Section 14.

4.1 Source Inputs and Record Outputs

The input selection buttons arranged along the upper bank select the source signal to be routed to the power amplifier and the loudspeakers. Below them, in the lower bank, is a corresponding array of buttons which select the signal to be routed to the preamplifier's record outputs.

These separate source and record sections enable one source (a CD player, for example) to be listened to whilst the output from another (say, the tuner) is simultaneously selected for recording.

Note: *It is possible to lock the record controls and prevent accidental de-selection during recording. Record-lock is switched on or off by pressing the source mono button four times within six seconds.*

Indicators are fitted to the NAC 552 rear panel above each input socket. These indicators illuminate to provide information on input selection and on input mapping setup and programming.

4.2 Input Socket Assignment

Any NAC 552 source input socket can be selected by any button. For example, while the NAC 552 default setup is for the **cd** input button to select input socket No. 2, custom programming of input assignment could enable any input socket to be selected by pressing the **cd** button. Assigning of each record button follows the corresponding source button.

Input assignment setup is accessed through the NAC 552 **program mode**. To switch into (or exit from) program mode press and hold the **prog** key on the NARCOM 4 remote handset (in preamplifier mode). Program mode is indicated by a flashing indicator on the front panel volume control and the record selection indicators extinguishing.

Note: *If no function is operated within five minutes of entering program mode the NAC 552 will return to normal mode automatically.*

Any of the six source buttons on the front panel can be assigned to any of the nine stereo inputs (seven DIN sockets and two RCA Phono socket pairs) on the rear panel. In program mode, as a source input is selected, a rear panel indicator will illuminate to designate the socket to which it is assigned.

To change the input socket assigned to a source button, select the **source** button and use the front panel record **mute** and **mono** buttons to scroll along the input sockets. If the input socket selected is already assigned to a source button the indicator above the socket will flash repeatedly. It is possible to assign one input socket to more than one source button but NOT to assign multiple input sockets to one source button. The remote handset **record mute** and **mono** functions can also be used to set up input assignment.

To exit from program mode press and hold the **prog** key on the handset until the record select indicators are restored and the volume indicator stops flashing.

Table 4.3 illustrates the NAC 552 default input assignment.

NAC 552

4.3 Socket Types and Assignment Defaults

Input Socket Number	Socket Features	Source Button Assignment Default
1	DIN input	Not assigned
2	DIN input	cd
3	DIN input	tuner
4	DIN input/output, AV Bypass capable	tape
5	DIN input/output, AV Bypass capable	av
6	DIN input/output	aux 1
7	DIN input, power output for phono stage	aux 2
8	RCA Phono pair	Not assigned
9	RCA Phono pair	Not assigned

4.4 Record Mute

At times when the NAC 552 record outputs are not required it is good practice to mute them in order to minimise power consumption and maximise sound quality.

To engage the NAC 552 record mute simply press the record (lower) bank front panel **mute** button.

4.5 NAC 552 Signal Outputs

To ensure correct continuity of system earth connections the NAC 552 signal output is routed via the NAC 552PS power supply. The NAC 552PS is fitted with multiple DIN signal output sockets that enable the downstream connection of a stereo power amplifier, a dual mono power amplifier or two separate mono power amplifiers.

4.6 Auxiliary Power Output

The NAC 552 Input 7 socket is intended for use with a Naim Audio StageLine or SuperLine phono stage and incorporates an appropriate DC power supply.

5 NAC 552 Connections and Controls

5.1 NAC 552 Rear Panel Connections

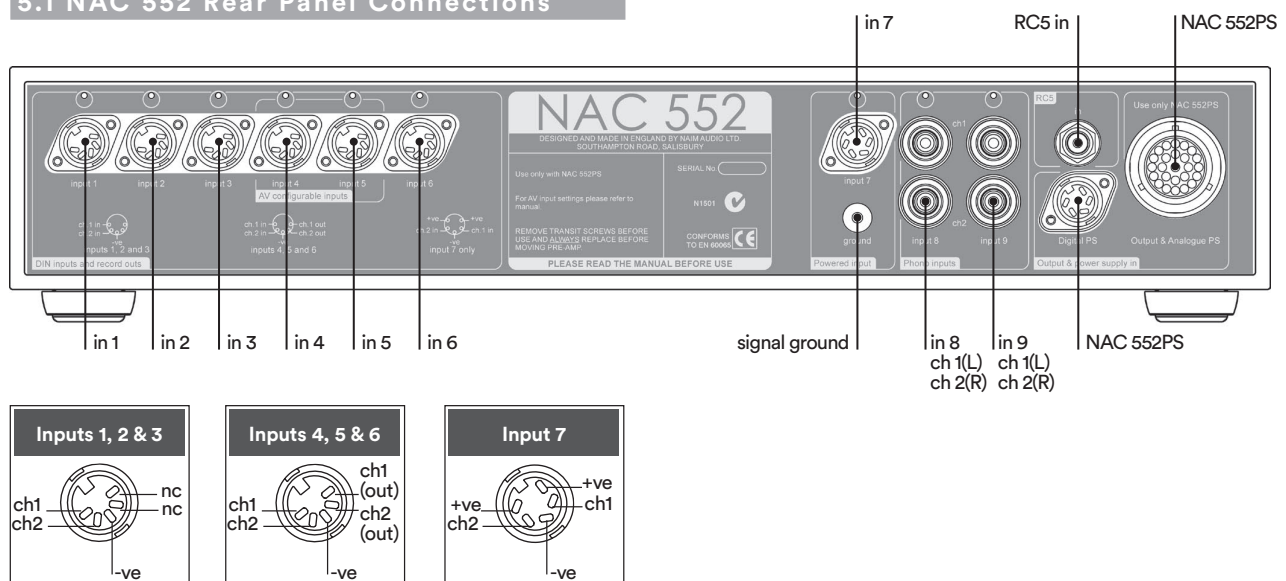

NAC 552

5.2 NAC 552 Connected to NAC 552PS

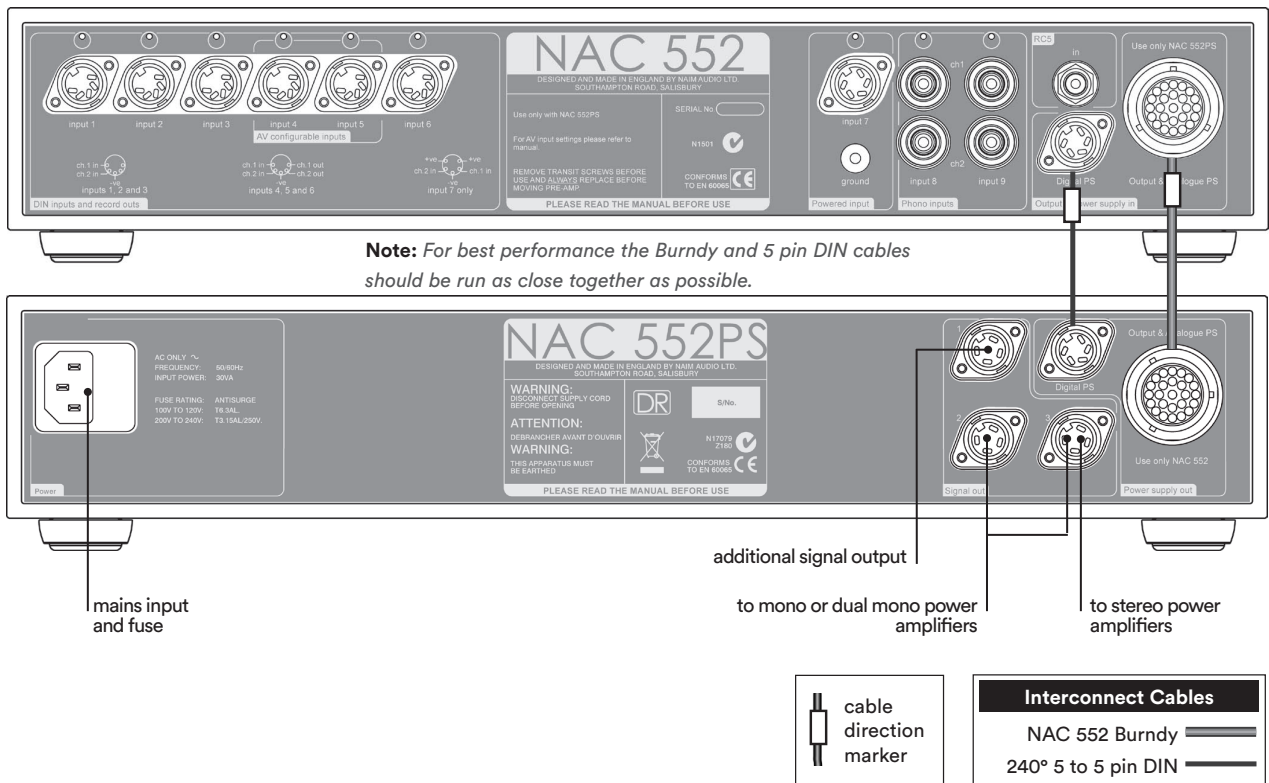

5.3 NAC 552 Front Panel Controls

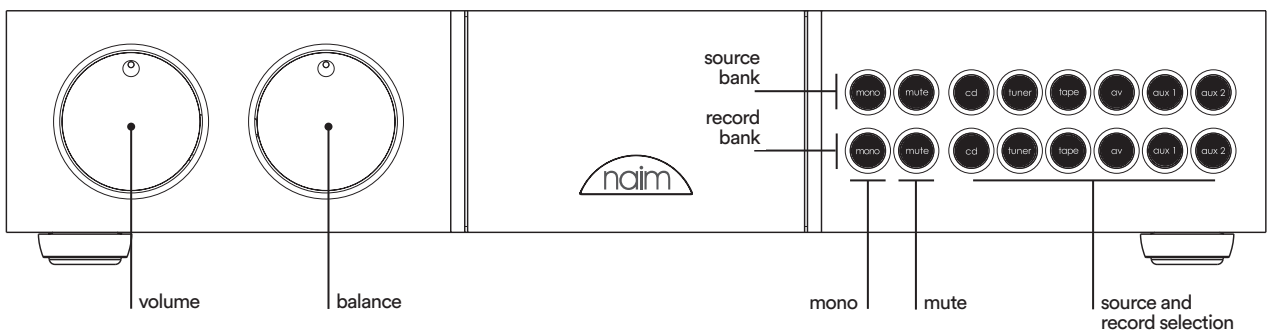

6 Specification

Input Sensitivities:	75mV, 47kΩ
Overload Margins:	40dB
	(all inputs all audio frequencies).
Main Output Level:	0.775V, <50Ω
Tape Output Level:	75mV, 600Ω
Auxiliary Power Outputs:	For Naim phono stage
Power Supply:	NAC 552PS
Dimensions (H x W x D):	Both 87 × 432 × 314mm
Weight:	NAC 552 - 12.9kg
	NAC 552PS - 13.9kg
Mains Supply (NAC 552PS):	100V, 115V or 230V, 50/60Hz

NAC 252

7 NAC 252 Introduction and Installation

The NAC 252 preamplifier does not incorporate an internal power supply and can be used only in conjunction with a SuperCap power supply. Diagram 8.2 illustrates connection of the NAC 252 to a SuperCap power supply.

The preamplifier and power supply should be installed on a dedicated equipment stand intended for the purpose. Do not stand either directly on top of another item of equipment. Care should be taken to ensure that the preamplifier is level.

The preamplifier and power supply should be installed in their final locations before connecting cables or switching on. Ensure that power amplifiers are switched off and the preamplifier volume is turned down before the power supply is switched on. The power button is located on the power supply front panel.

The power supply is heavy and care should be taken when lifting or moving it. Make sure that the surface on which it is to be placed can support its weight.

The following paragraphs describe installation features and functions specific to the NAC 252. Operational features common to all preamplifiers are described in Section 14.

Operational features common to all preamplifiers are described in Section 14

7.1 Source Inputs and Record Outputs

The input selection buttons arranged along the upper bank select the source signal to be routed to the power amplifier and the loudspeakers. Below them, in the lower bank, are a corresponding array of buttons which select the signal to be routed to the preamplifier's record outputs.

These separate source and record sections enable one source (a CD player, for example) to be listened to whilst the output from another (say, the tuner) is simultaneously selected for recording.

Note: *It is possible to lock the record controls and prevent accidental de-selection during recording. Record-lock is switched on or off by pressing the source mon button four times within six seconds.*

7.2 Input Socket Assignment

The NAC 252 has six DIN input sockets and two alternative pairs of RCA Phono sockets. The RCA Phono sockets can be assigned individually to the **cd** and **aux 2** input buttons in place of the DIN sockets.

Input assignment setup is accessed through the NAC 252 program mode. To switch into (or exit from) program mode press and hold the **prog key** on the remote handset (in preamplifier mode). Program mode is indicated by a flashing indicator on the front panel volume control and the record selection indicators extinguishing.

Note: *If no function is operated within five minutes of entering program mode the NAC 252 will return to normal mode automatically.*

Once in program mode press and hold the remote handset **1** key to select or de-select the RCA Phono socket input for **cd**, and the remote handset **6** key to select or de-select the RCA Phono socket input for **aux 2**. The corresponding front panel input buttons can similarly be used to select or de-select the RCA Phono socket inputs. The appropriate input button indicator will flash three times on selection of the RCA Phono option and once on selection of the DIN option.

To exit from program mode press and hold the **prog** key on the handset until the record select indicators are restored and the volume indicator stops flashing.

7.3 Record Mute

At times when the NAC 252 record outputs are not required it is good practice to mute them in order to minimise power consumption and maximise sound quality.

To engage the NAC 252 record mute simply press the record (lower) bank front panel **mute** button.

7.4 NAC 252 Signal Outputs

To ensure correct continuity of system earth connections the NAC 252 signal output is routed via the SuperCap power supply. The SuperCap is fitted with multiple DIN signal output sockets that enable the downstream connection of a stereo power amplifier, a dual mono power amplifier or two separate mono power amplifiers.

7.5 Auxiliary Power Output

The NAC 252 Aux 2 input (In 6) is provided with primary and alternative DIN sockets. The lower, alternative, socket, fitted at manufacture with a removable cover, is intended for use with a Naim Audio StageLine or SuperLine phono stage and incorporates an appropriate DC power supply. The primary and alternative sockets must not be used simultaneously.

NAC 252

8 NAC 252 Connections and Controls

8.1 NAC 252 Rear Panel Connections

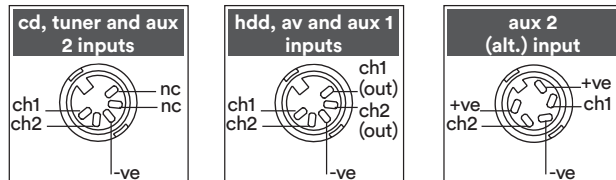
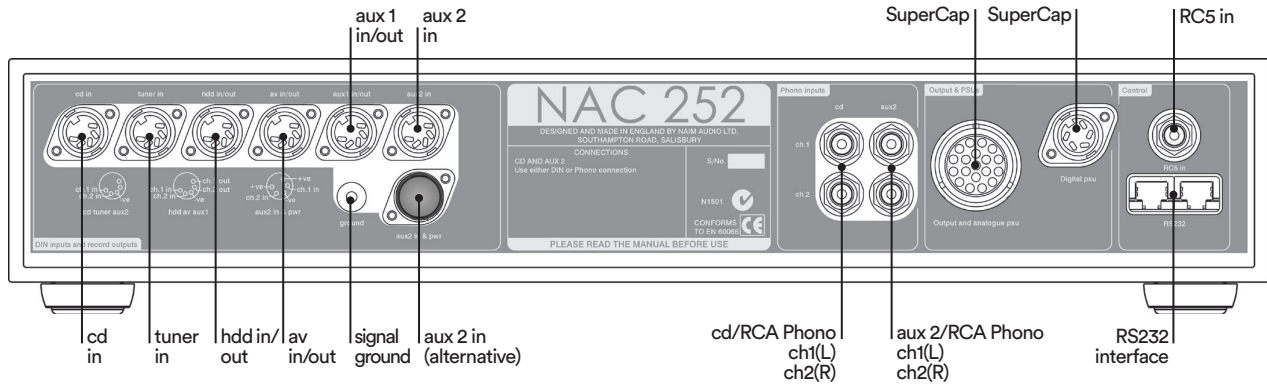

Note: The RS232 interface is an optional upgrade. It can be specified at time of order or fitted retrospectively. Contact your local distributor or Naim Audio directly for further information.

8.2 NAC 252 Connected to SuperCap

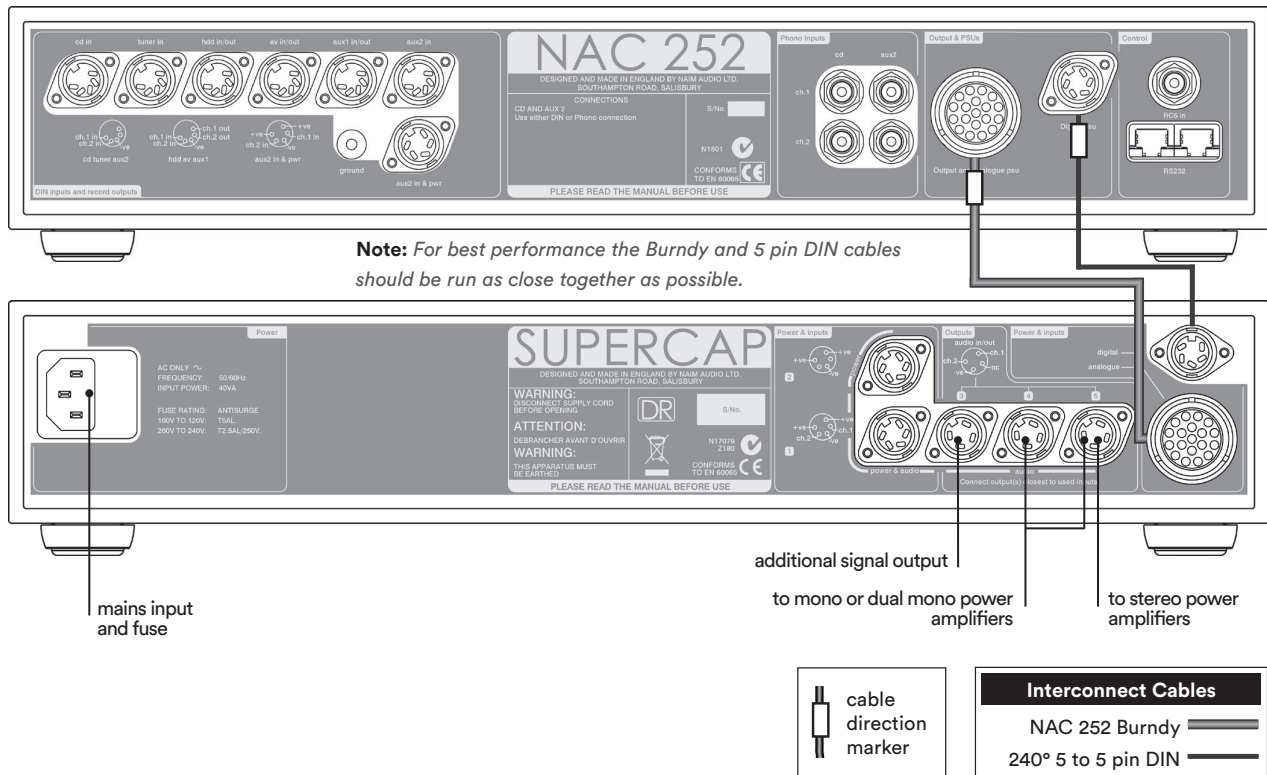

NAC 252

8.3 NAC 252 Front Panel Controls

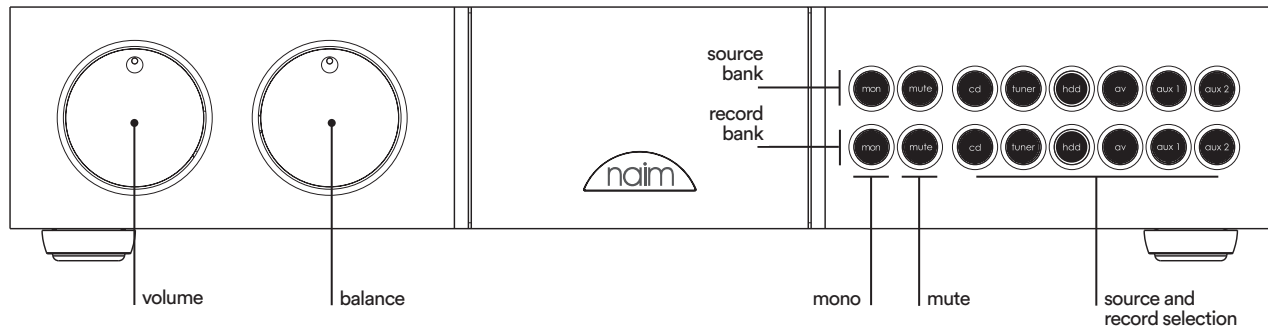

9 Specification

Input Sensitivities:	75mV, 47k Ω
Overload Margins:	40dB (all inputs all audio frequencies)
Main Output Level:	0.775V, <50 Ω
Hdd Output Level:	75mV, 600 Ω
Auxiliary Power Outputs:	For Naim phono stage.
Power Supply:	SuperCap
Dimensions (H x W x D):	Both 87 x 432 x 314mm
Weight:	NAC 252 - 7.0kg SuperCap - 11.6kg
Mains Supply (SuperCap):	100V, 115V or 230V, 50/60Hz

NAC 282, NAC 202 & NAC 152 XS

10 NAC 282, NAC 202 and NAC 152 XS Introduction and Installation

The NAC 282, NAC 202 and NAC 152 XS preamplifiers do not incorporate an internal power supply but must be used in conjunction with either a Naim power amplifier incorporating a preamplifier power output, or with an appropriate Naim power supply. The NAC 282 is however supplied with a NAPSC power supply that provides power to its display and control circuits. Diagrams 12.1 to 12.5 illustrate a variety of power supply connections and options.

The preamplifier and power supply, which may be a Naim power amplifier, should be installed on a dedicated equipment stand intended for the purpose. Do not stand either directly on top of another item of equipment. Care should be taken to ensure that the equipment stand is level.

The preamplifier and power supply should be installed in their final locations before connecting cables or switching on. Ensure that the preamplifier volume is turned down before switching on.

The following paragraphs describe installation features and functions specific to the NAC 282, NAC 202 and NAC 152 XS. Operational features common to all preamplifiers are described in Section 14.

Operational features common to all preamplifiers are described in Section 14

10.1 NAC 282 Source Inputs and Record Outputs

The NAC 282 provides both input and record output selection buttons arranged in two banks on its front panel.

The input selection buttons are arranged along the upper bank and select the source signal to be routed to the power amplifier and the loudspeakers. Below them, in the lower bank, are a corresponding array of buttons which select the signal to be routed to the NAC 282 record outputs.

These separate source and record sections enable one source (a CD player, for example) to be heard whilst the output from another (say, the tuner) is simultaneously selected for recording.

Note: *It is possible to lock the record controls and prevent accidental de-selection during recording. Record-lock is switched on or off by pressing the source mon button four times within six seconds.*

10.2 NAC 282 and NAC 202 Input Socket Assignment

The input selection buttons select the source input signal to be routed to the power amplifier and the loudspeakers.

The NAC 282 and NAC 202 have six DIN input sockets and two alternative pairs of RCA Phono sockets. The RCA Phono sockets can be assigned individually to the **cd** and **aux 2** input buttons in place of the DIN sockets.

Input assignment setup is accessed through preamplifier **program mode**. To switch into (or exit from) program mode press and hold the **prog** key on the remote handset (with the handset in preamplifier mode). Program mode is indicated by a flashing indicator on the front panel volume control and, on the NAC 282, the record selection button indicators extinguishing.

Note: *If no function is operated within five minutes of entering program mode the preamplifier will return to normal mode automatically.*

Once in program mode press and hold the remote handset **1** key to select or de-select the RCA Phono socket input for **cd**, and the remote handset **6** key to select or de-select the RCA Phono socket input for **aux 2**. The corresponding front panel input buttons can similarly be used to select or de-select the RCA Phono socket inputs. The appropriate input button indicator will flash three times on selection of the RCA Phono option and once on selection of the DIN option.

To exit from program mode press and hold the **prog** key on the handset until the record select indicators are restored and the volume indicator stops flashing.

10.3 NAC 282 and NAC 202 Record Mute

At times when the NAC 282 or NAC 202 record outputs are not required it is good practice to mute them in order to minimise power consumption and maximise sound quality.

10.3.1 NAC 282 Record Mute

To engage the NAC 282 record mute simply press the record (lower) bank front panel **mute** button.

10.3.2 NAC 202 Record Mute

To engage or disengage the NAC 202 **record mute** press the front panel **mon** button followed by the front panel **mute** button. The **mute** button indicator will illuminate when record mute is engaged and extinguish when it is disengaged. Record mute can also be engaged and disengaged from the remote handset using the **mon** and **mute** keys.

NAC 282, NAC 202 & NAC 152 XS

10.4 NAC 152 XS Source Inputs

The NAC 152 XS input selection buttons select the source input signal to be routed to the preamplifier outputs and the power amplifier.

The NAC 152 XS has six DIN input sockets and five pairs of RCA Phono sockets. The RCA Phono sockets are permanently connected in parallel with their respective DIN sockets. RCA Phono and DIN sockets for the same input should not be connected simultaneously.

A 3.5mm stereo Jack input socket suitable for a variety of portable music players is also provided on the NAC 152 XS front panel. This input is connected in parallel with the aux 1 DIN and RCA Phono sockets. Insertion of a plug into the front panel socket will automatically switch the preamplifier to that input. Removal of the plug will return the amplifier to the previously selected input. If a different input is selected while a plug is inserted, removal of the plug will not cause the input to change.

10.5 Signal Outputs

10.5.1 Preamplifier Outputs

The NAC 282, NAC 202 and NAC 152 XS each provide two primary preamplifier output options:

- If the preamplifier is to be used with a Naim power amplifier that provides a preamplifier power supply the **Standard** DIN output socket should be used.
- If the preamplifier is to be used with a separate external power supply, in order to ensure correct continuity of system earth connections, the signal output is routed via the power supply. In this case, depending on the specific power supply model to be used, either one or both of the preamplifier link and blanking plugs should be removed and the power supply connected to the **Link** and **Upgrade** DIN sockets.

The power supply is fitted with multiple DIN signal output sockets that enable the downstream connection of a stereo power amplifier, a dual mono power amplifier or two separate mono power amplifiers.

Diagrams 12.1 to 12.5 illustrate a variety of external power supply connection schemes.

10.5.2 NAC 152 XS Line and Subwoofer Outputs

In addition to its DIN socket preamplifier outputs, the NAC 152 XS provides subwoofer and line level outputs, each via a pair of RCA Phono sockets.

The line level output simply reflects the selected input signal while the subwoofer output is a duplicate of the main preamplifier output (i.e. it is affected by the preamplifier volume control).

10.6 Auxiliary Power Outputs

The NAC 282, NAC 202 and NAC 152 XS Aux 2 input is provided with primary and alternative DIN sockets. The alternative socket, fitted at manufacture with a removable cover, is intended for use with a Naim Audio StageLine or SuperLine phono stage and incorporates an appropriate DC power supply. The primary and alternative sockets must not be used simultaneously.

10.7 Power Supply Upgrades

The NAC 282, NAC 202 and NAC 152 XS can each be powered by a Naim power amplifier incorporating a preamplifier power supply. Alternatively however their performance can be significantly upgraded through the use of one or more external power supplies. Power supply upgrades can be carried out in stages. Table 10.7.1 below describes some power supply upgrade options for each preamplifier. In addition to those described in the table a variety of different power supply upgrade schemes are possible. Your local Naim representative will be able to advise on the best scheme for your particular system.

NAC 282, NAC 202 & NAC 152 XS

10.7.1 Power Supply Upgrade Options

Pre-amplifier	Stage 1 Upgrade	Stage 2 Upgrade	Stage 3 Upgrade
NAC 282	Use: Hi-Cap Connect to: Upgrade 1 socket Connect: Power amp to Hi-Cap	Use: 2 x Hi-Cap Connect to: Upgrade 1 & 2 sockets Connect: Power amp to Hi-Cap 1	Use: SuperCap Connect to: Upgrade 1 & 2 sockets Connect: Power amp to SuperCap
NAC 202	Use: NAPSC Connect to: NAPSC socket Connect: Power amp to preamp	Use: Hi-Cap Connect to: Upgrade 2 socket Connect: Power amp to Hi-Cap	Use: SuperCap Connect to: Upgrade 2 socket Connect: Power amp to SuperCap
NAC 152 XS (see Note)	Use: FlatCap XS (both outputs) Connect to: Upgrade 1 & 2 sockets Connect: Power amp to Flatcap XS	Use: FlatCap XS and Hi-Cap Connect to: Upgrade 1 & 2 sockets Connect: Power amp to Hi-Cap	Use: 2 x Hi-Cap Connect to: Upgrade 1 & 2 sockets Connect: Power amp to Hi-Cap 2

Note: A NAC 152 XS may also be powered by a single FlatCap even if one FlatCap output is already in use to power a CD5 XS CD player. The FlatCap should be connected to the preamplifier Upgrade 1 socket with the power amplifier left connected directly to the preamplifier.

Note: Section 12 comprises diagrams illustrating some of these power supply options.

11 NAC 282, NAC 202 and NAC 152 XS Rear Panel Connections

11.1 NAC 282 Rear Panel Sockets

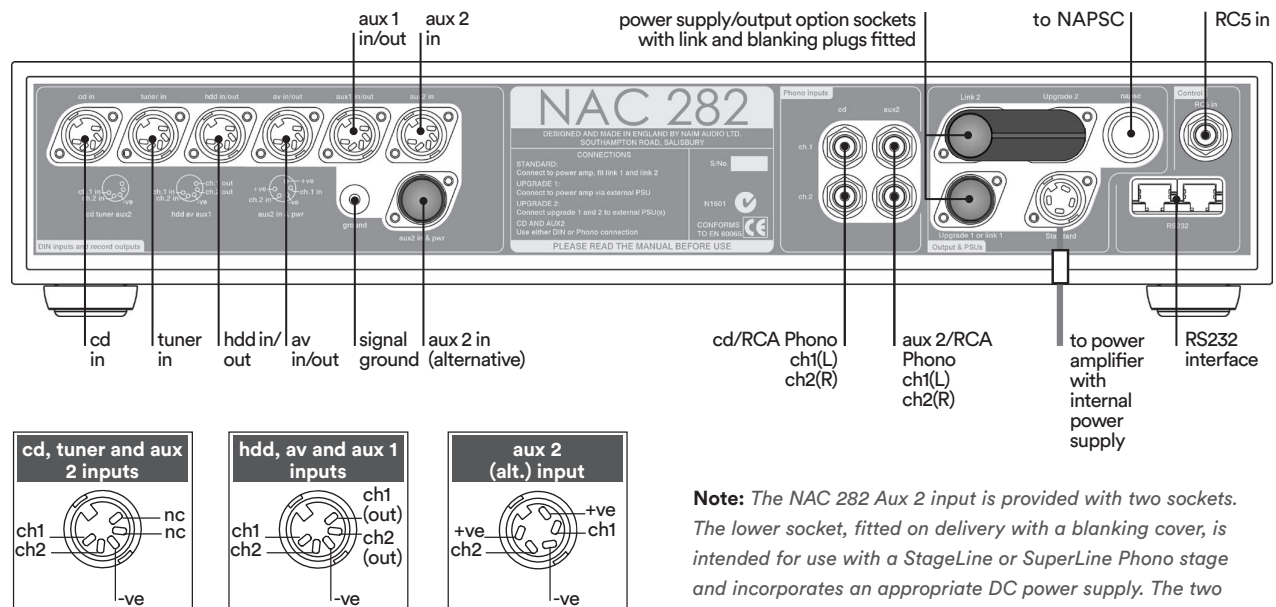

Note: The NAC 282 Aux 2 input is provided with two sockets. The lower socket, fitted on delivery with a blanking cover, is intended for use with a StageLine or SuperLine Phono stage and incorporates an appropriate DC power supply. The two sockets must not be used simultaneously.

Note: The RS232 interface is an optional upgrade. It can be specified at time of order or fitted retrospectively. Contact your local representative or Naim Audio directly for further information.

NAC 282, NAC 202 & NAC 152 XS

11.2 NAC 202 Rear Panel Sockets

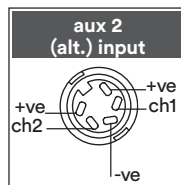
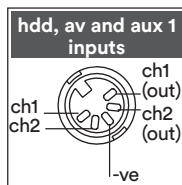
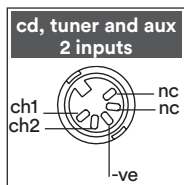
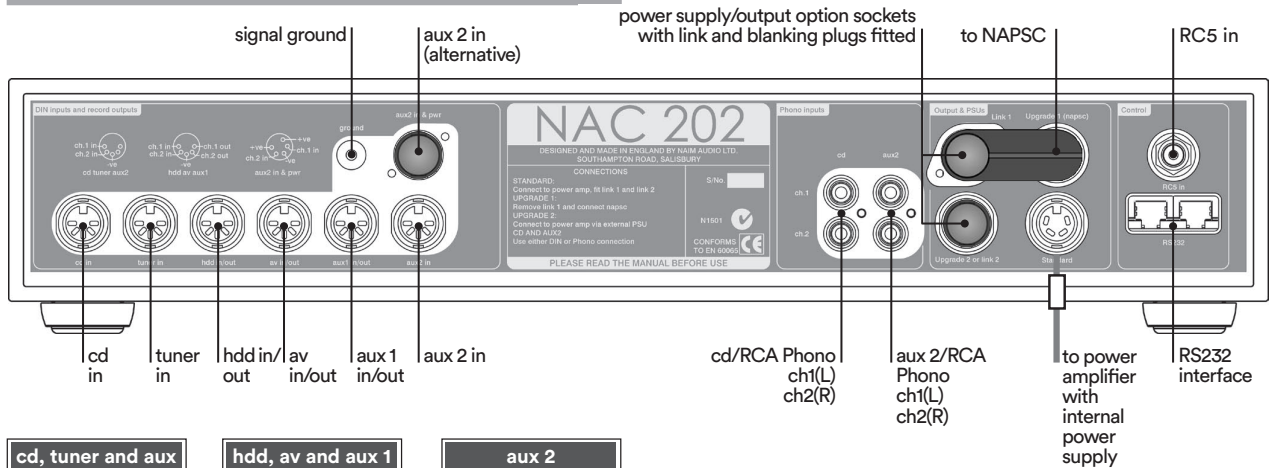

Note: The NAC 202 features various technologies to reduce microphonic effects, consequently some movement sockets when connecting and disconnecting cables is normal.

Note: The NAC 202 Aux 2 input is provided with two sockets. The upper socket, fitted on delivery with a blanking cover, is intended for use with a Stageline or SuperLine Phono stage and incorporates an appropriate DC power supply. The two sockets must not be used simultaneously.

Note: The RS232 interface is an optional upgrade. It can be specified at time of order or fitted retrospectively. Contact your local representative or Naim Audio directly for further information.

11.3 NAC 152 XS Rear Panel Sockets

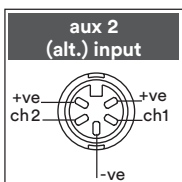
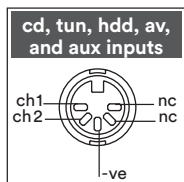
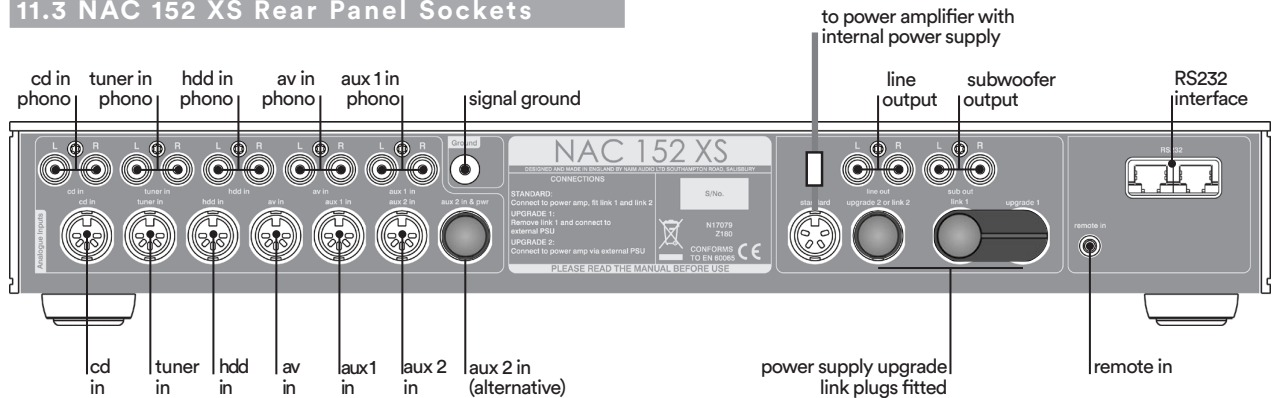

Note: The NAC 152 XS features various technologies to reduce microphonic effects, consequently some movement sockets when connecting and disconnecting cables is normal.

Note: The NAC 152 XS Aux 2 input is provided with two sockets. The right hand socket (fitted on delivery with a blanking cover), is intended for use with a Stageline or SuperLine phono stage and incorporates an appropriate DC power supply. The two sockets must not be used simultaneously.

Note: The RS232 interface is an optional upgrade. It can be specified at time of order or fitted retrospectively. Contact your local representative or Naim Audio directly for further information.

NAC 282, NAC 202 & NAC 152 XS

12 NAC 282, NAC 202 and NAC 152 XS Power Supply Connections

12.1 NAC 282 Connected to Hi-Cap and NAPSC

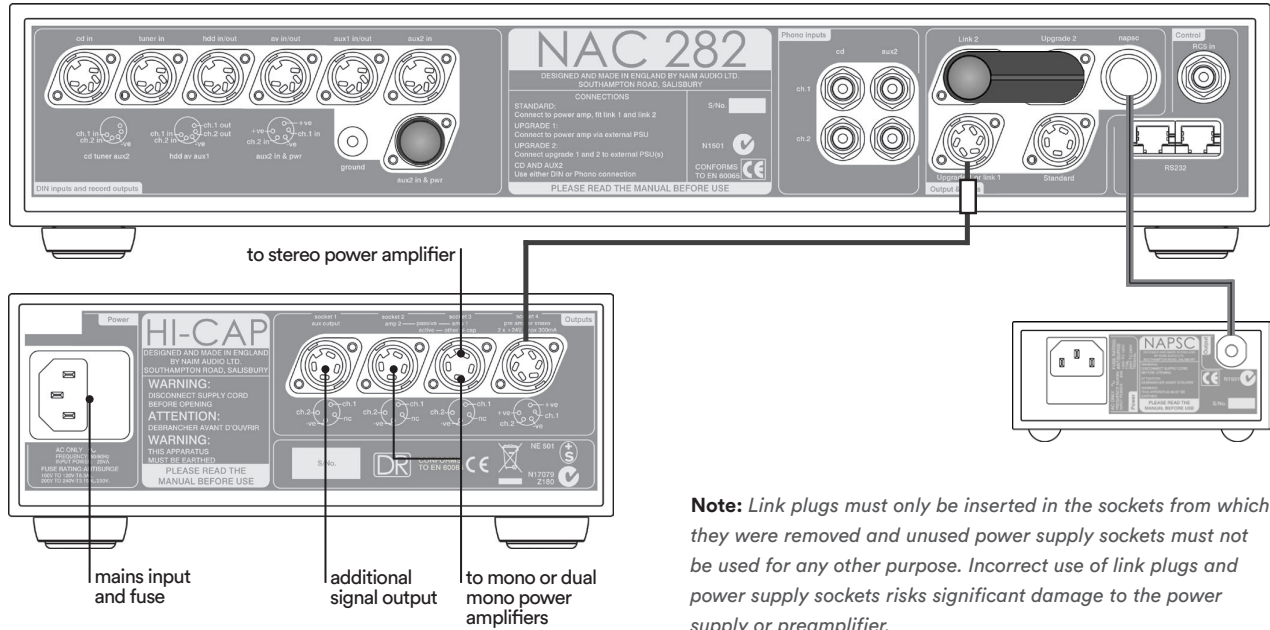

12.2 NAC 282 Connected to SuperCap and NAPSC

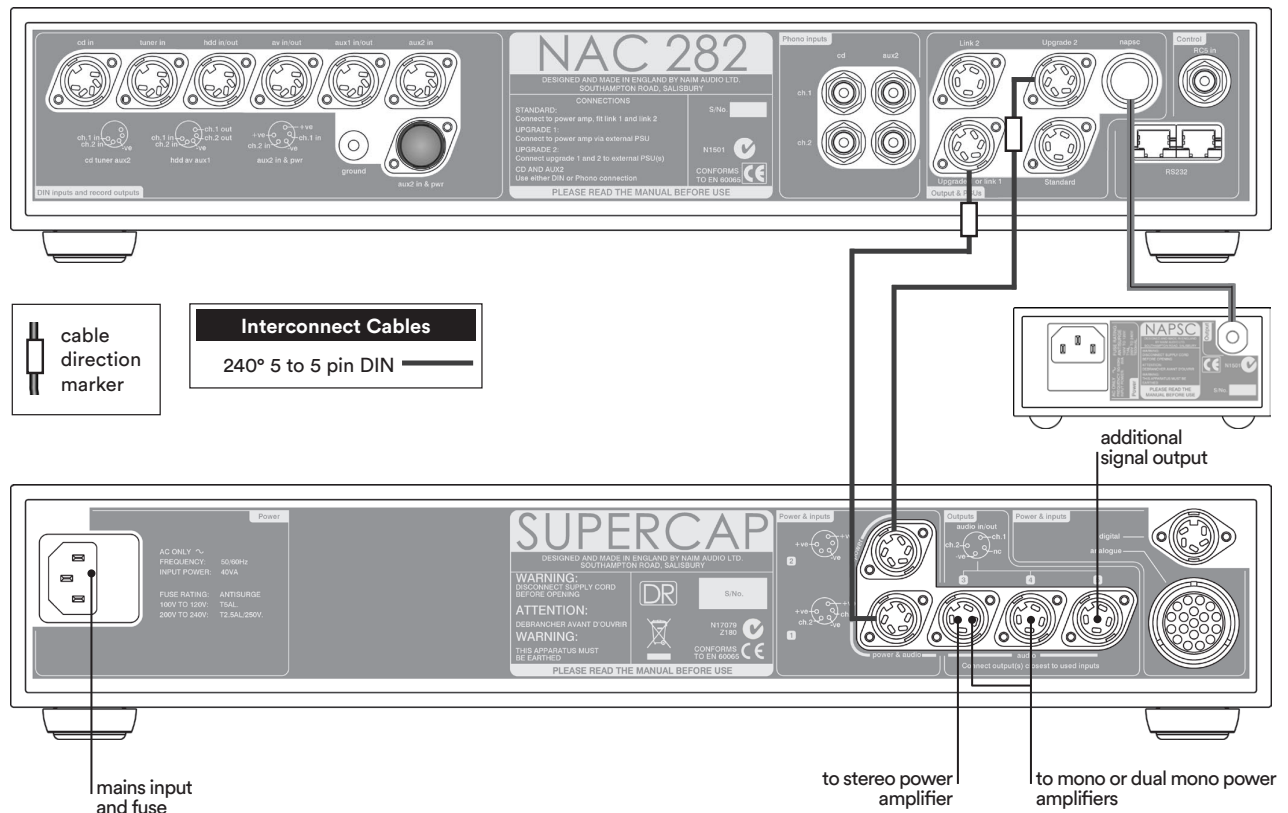

NAC 282, NAC 202 & NAC 152 XS

12.3 NAC 202 Connected to Hi-Cap and NAPSC

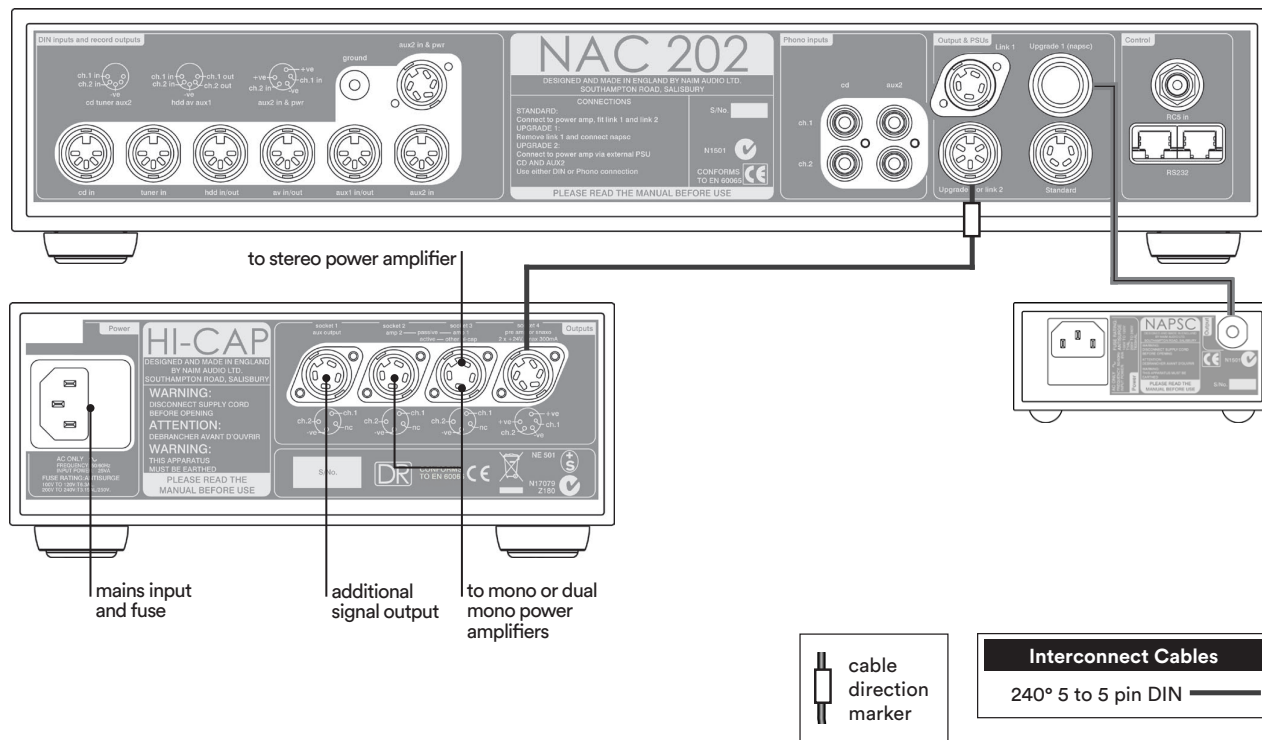

12.4 NAC 152 XS Connected to FlatCap (both outputs)

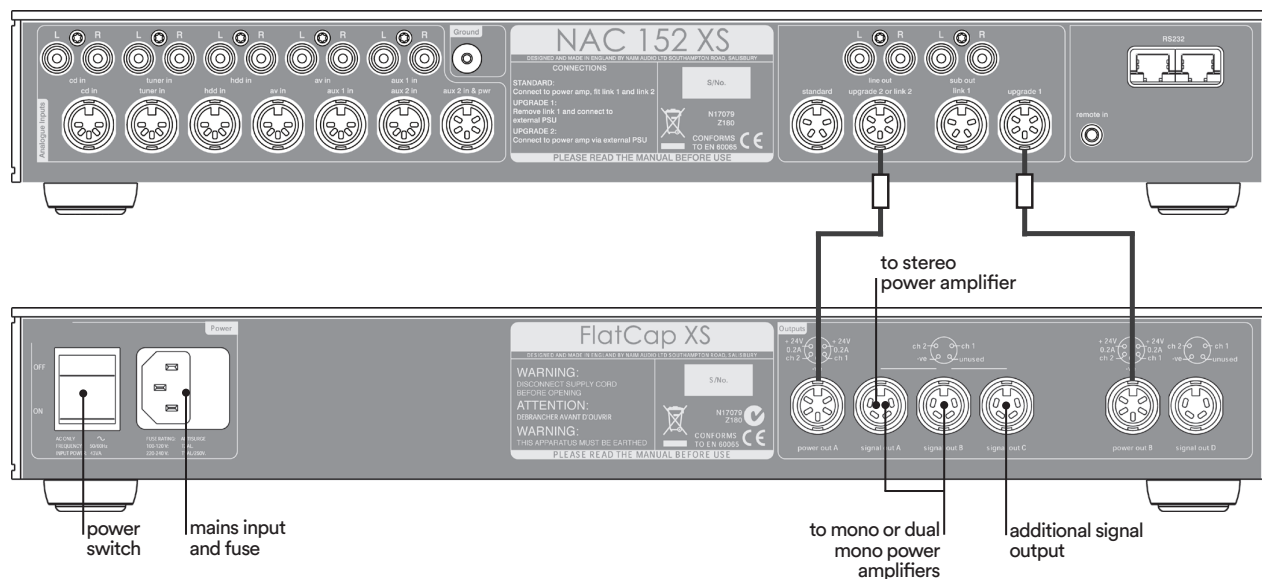

NAC 282, NAC 202 & NAC 152 XS

12.5 NAC 152 XS Connected to FlatCap and Hi-Cap

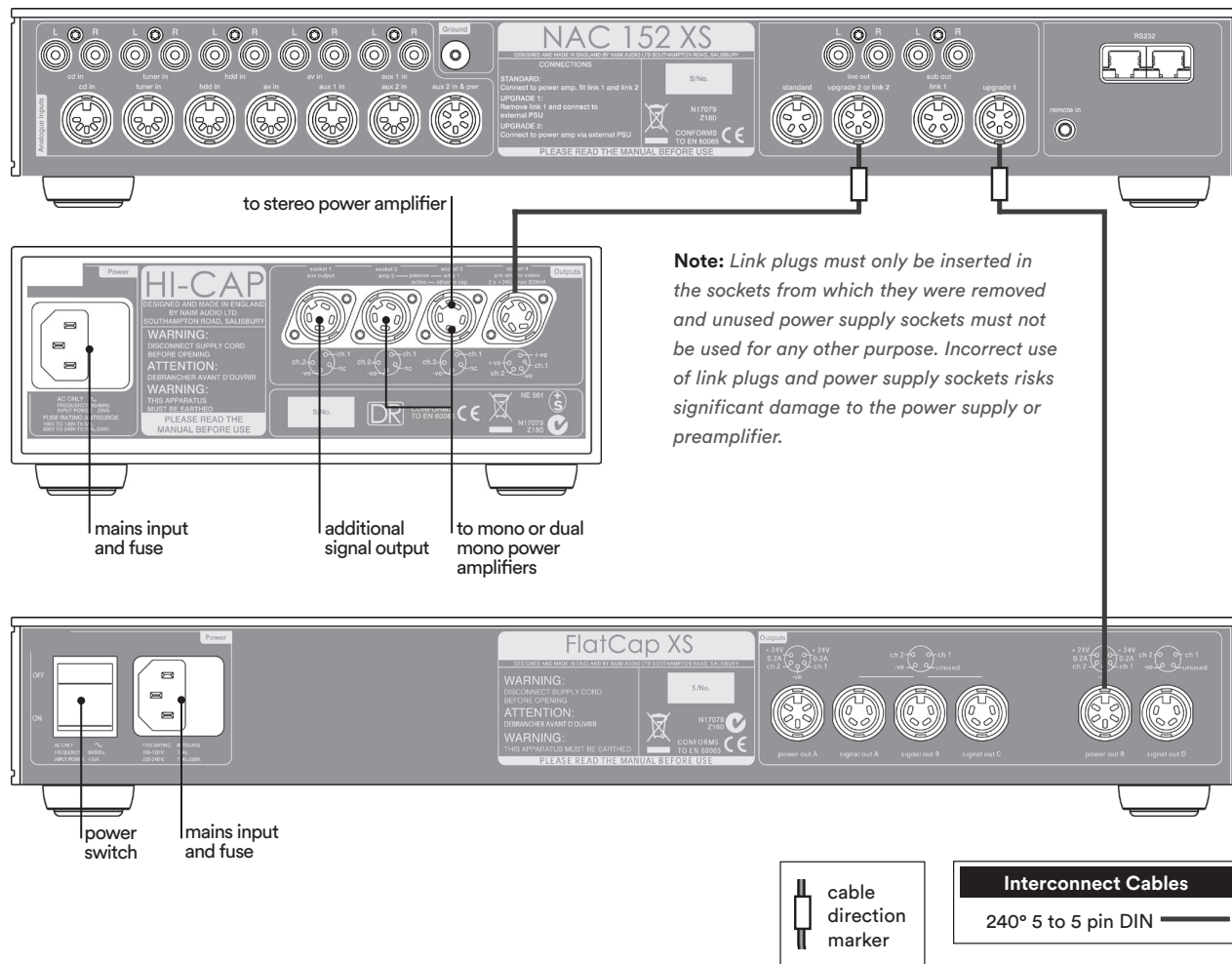

12.6 NAC 282 Front Panel Controls

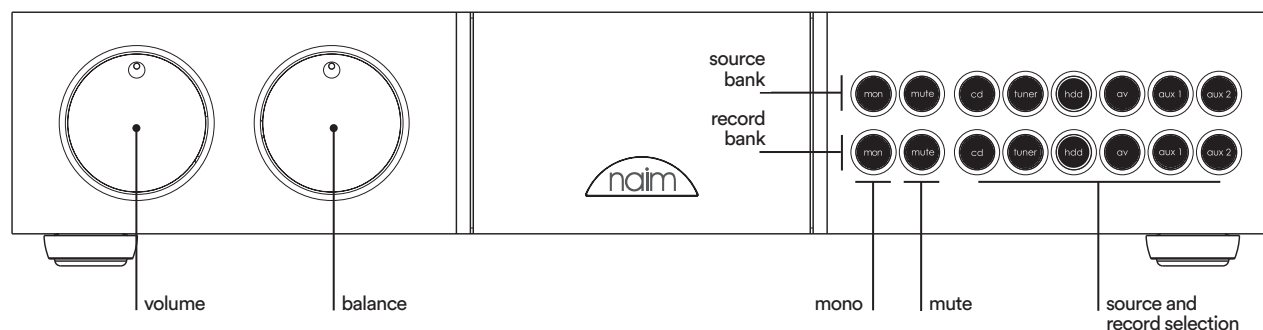

NAC 282, NAC 202 & NAC 152 XS

12.7 NAC 202 Front Panel Controls



12.8 NAC 152 XS Front Panel Controls

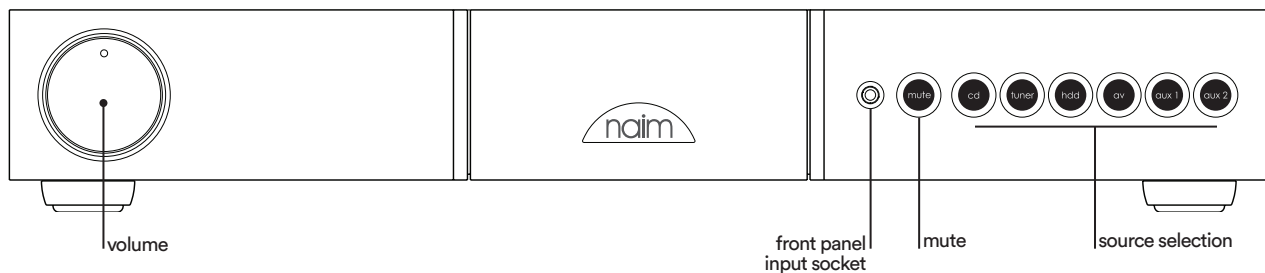

13 Specifications

	NAC 282	NAC 202	NAC 152 XS
Input Sensitivities:	75mV, 47kΩ	75mV, 47kΩ	130mV, 47kΩ
Overload Margins: (All inputs, audio frequencies)	40dB	40dB	35dB
Main Output Level:	0.775V, <50Ω	0.775V, <50Ω	0.775V, <50Ω
Hdd Output Level:	75mV, 600Ω	75mV, 600Ω	130mV, 600Ω
Auxiliary Power Outputs:	For Naim phono stage.	For Naim phono stage.	For Naim phono stage.
Power Supply Options:	_____	SuperCap, Hi-Cap, FlatCap, Power amp	_____
Dimensions (H x W x D):	87 x 432 x 314mm	87 x 432 x 314mm	70 x 432 x 301mm
Weight:	7.0kg	7.0kg	3.9kg
Mains Supply: (Power Supply)	_____	100V, 115V or 230V, 50/60Hz	_____

Preamplifier Operation

14 Preamplifier Operation

Many operational and control features of Naim preamplifiers are common to all and are based on a similar user interface. This section of the manual describes those features and the user interface, drawing attention to differences between products where they occur. Table 14.9 sets out some variations in user interface between products.

Front panel controls are duplicated on the remote control handset which may also provide some extra functions. See Sections 15 and 16 for more information.

14.1 Automatic Input Switching

With **Automatic Input Switching** engaged the appropriate source input will be selected as soon as any handset function for that (Naim) source component is operated. For example, if the tuner input is selected and the **cd** play key is pressed on the handset, the preamplifier will automatically switch to the **cd** input. Automatic Input Switching can be programmed to operate on any combination of the cd, tuner, av and hdd (NAC 152 XS only) input buttons (and sockets to which they are assigned).

To enable Automatic Input Switching, first switch the preamplifier into program mode by pressing and holding the handset **prog** key (with the handset in preamplifier mode). The front panel **mon** button (NAC552 **mono** and NAC 152XS **mute** buttons) will illuminate if automatic switching is already enabled. If it is not enabled it can be switched on by pressing the same button.

With automatic switching enabled, pressing the button again will reveal the inputs selected for auto switching by their indicators illuminating for a short time. Repeated operation of the button will sequentially select through each possible combination of cd, tuner, av and hdd (NAC 152 XS only) inputs and auto switching disabled (all indicators off). When the desired inputs selected for auto switching are indicated, stop pressing the button.

Automatic Input Switching only becomes operational on exit from program mode by pressing and holding the handset **prog** key.

Note: *The preamplifier will leave program mode automatically if no control commands are received for five minutes.*

Note: *In a few cases some further equipment configuration may be required for auto switching to operate correctly. Please contact your retailer or local distributor for advice.*

14.2 AV Bypass

AV Bypass enables an audio-visual processor to be integrated such that its volume control takes over command of signals connected to selected preamplifier inputs. On the NAC 552 AV Bypass may be selected on DIN input sockets **4** and **5**. On all other preamplifiers it may be selected on only the **av** input.

To select AV Bypass, first switch the preamplifier into program mode by pressing and holding the handset **prog** key (with the handset in preamplifier mode). The front panel **source mute** button (NAC 202 **mute** button, NAC 152 XS **av** button) will illuminate if AV Bypass is selected. If it is not enabled it can be switched on by pressing the same button twice.

With AV Bypass enabled on the NAC 552, pressing the **source mute** button again will reveal the inputs selected by their indicators illuminating for a short time. Repeated operation of the button will sequentially select each combination of the available inputs, and AV Bypass disabled. When the desired inputs are indicated, stop pressing the button. The selected inputs will then be enabled for AV Bypass. The handset can also be used to select AV Bypass. See table 14.9.

AV Bypass only becomes operational on exit from program mode by pressing and holding the handset **prog** key.

Note: *The preamplifier will leave program mode automatically if no control commands are received for five minutes.*

Note: *The AV Bypass feature must be used with care. It effectively by-passes the preamplifier volume and balance controls leaving any signal connected to an AV Bypass input to be passed to the power amplifier and speakers at full volume. In order to reduce the potential for inadvertent mishap, any subsequent modifications to input assignment will automatically disable previously set up AV Bypass inputs. Additionally, if an input is selected which has AV Bypass enabled, the preamplifier volume and balance handset functions will be disabled and their indicators will turn off. This will be flagged by the volume or balance indicators flashing if either handset function is operated.*

Preamplifier Operation

14.3 Handset Volume and Balance Control

The remote handset **volume** and **balance** keys provide some alternative control characteristics.

With the NAC 552, NAC 252, NAC 282 and NAC 202 a quick press and release of a key will adjust by a preset “nudge”. A quick press and release of a key followed by press and hold will cause continual slow adjustment. Simple press and hold will cause continual fast adjustment.

With the NAC 152 XS, a short press and release of a key will adjust by a preset “nudge”, while pressing and holding the key will result in three seconds of slow adjustment followed by continual fast adjustment.

Note: *The NAC 152 XS does not incorporate any facility for channel balance control.*

14.4 Mute, Mono and Mon

Mute silences the output signal and can be selected by pressing the front panel **mute** button. On preamplifiers equipped with separate source and record sections Mute can be selected independently for source and record. Mute can also be selected from the handset.

Some preamplifiers include a **mon** (mono) function that sums the left and right channels. Mono can be selected by pressing the front panel **mon** (NAC 552 **mono**) button. On preamplifiers equipped with separate source and record sections mono can be selected independently for source and record. Mono can also be selected from the handset.

Note: *The NAC 202 and NAC 152 XS do not incorporate any mono facility.*

The NAC 202 incorporates a **mon** (“tape monitor”) function. Pressing the **mon** button routes the **hdd**, **av** or **aux 1** input signals to the preamplifier output while leaving the input selection routed to the **hdd**, **av** and **aux 1** outputs. The **mon** function can also be selected from the handset.

Note: *Only the hdd, av and aux 1 inputs (those that incorporate outputs) can be selected when mon is engaged. However, if one of these inputs carries the source signal, that input will be unavailable for monitoring.*

Note: *The record mute function on the NAC 552, NAC 252, NAC 282 and NAC 202 is engaged by default. It can be disengaged on the NAC 202 by pressing the mute button while mon is engaged. See Section 10.3.*

Note: *The NAC 152 XS does not incorporate any front panel monitor facility.*

14.5 Display

The preamplifier front panel button illumination can be switched off by pressing the remote handset (in preamplifier mode) **disp** function. Any subsequent handset or front panel operation will temporarily restore the display. A second operation of the **disp** function will restore the display.

14.6 Switching On

After switch-on, via the power amplifier or power supply **power** button, the preamplifier will remain muted for 30 seconds while control systems and circuits stabilise.

14.7 Defaults

To restore all programmable settings to the factory defaults press and hold the remote handset **disp** key while the preamplifier is in program mode. The preamplifier will exit from program mode following this operation.

Preamplifier Operation

14.8 Fault Conditions

Some preamplifier models will indicate power supply or link plug faults by flashing a specific front panel button indicator. These fault indications are listed below:

Preamplifier Power Supply or Link Plug Fault Indication

NAC 252	source mute flashing
NAC 282	source mute flashing
NAC 202	mute flashing
NAC 152 XS	mute flashing

14.9 Interface Function Buttons and Keys

Preamplifier	Program Mode	Auto Input Switching	AV Bypass	Restore Defaults	
NAC 552	hold pre hold prog	N/A pre ▶ mon source mono	N/A pre ▶ mute source mute	N/A hold disp	handset key (R-com) handset key(s) (NARCOM 4) front panel button
NAC 252	hold prog	pre ▶ mon source mon	pre ▶ mute source mute	hold disp	handset key(s) (NARCOM 4) front panel button
NAC 282	hold prog	pre ▶ mon source mon	pre ▶ mute source mute	hold disp	handset key(s) (NARCOM 4) front panel button
NAC 202	hold prog	pre ▶ mon mon	pre ▶ mute mute	hold disp	handset key(s) (NARCOM 4) front panel button
NAC 152 XS	hold prog	pre ▶ mute mute	pre ▶ av av	hold disp	handset key(s) (NARCOM 4) front panel button

Note: The handset must be in preamplifier mode to select program mode or to restore defaults.

Note: The ▶ symbol indicates sequential key operations.

R-com Remote Handset

15 R-com Remote Handset

The R-com remote handset is supplied with the NAC 552 and can be purchased as an accessory. It offers quick and intuitive control of the most often used functions of CD players, preamplifiers, integrated amplifiers and tuners.

To fit batteries, remove the bottom end cover using the tool provided and insert the batteries into the body taking care with their orientation. Replace the end cover. Remove the batteries if the R-com is to be packed and shipped.

15.1 Using R-com

R-com keys primarily provide control of the functions most often used on CD players, preamplifiers, integrated amplifiers and tuners. In order to extend battery life, R-com will enter a "sleep" mode when unused. It will "wake" on being touched.

R-com has three operational modes - CD Player mode, Preamplifier/Integrated amplifier mode and Tuner mode. Its default mode is CD player. When awake in CD Player mode, all R-com keys will illuminate green. To switch the R-com into Preamplifier/Integrated amplifier mode or Tuner mode press the **pre** or **tun** keys respectively. The **pre** or **tun** key will then illuminate white. To switch R-com back into CD player mode either press the **pre** or **tun** key again.

In default mode the R-com keys have the following functions:

- disp:** Scrolls through the display options of track, time and display off.
- open:** Opens the door on the CD555.
- stop:** Stops CD replay.
- play:** Begins CD replay.
- prev:** Selects the previous track or index point.
- next:** Selects the next track or index point.
- vol +:** Increases the preamplifier/integrated amplifier volume.
- vol -:** Decreases the preamplifier/integrated amplifier volume.
- mute:** Reduces the volume to zero. A second press restores the volume.
- pause:** Pauses CD replay. A second press restores play.

In Preamplifier/Integrated amplifier mode (press **pre** key), the following keys will change function:

- disp:** Switches the preamplifier/integrated amplifier front panel button indicators & knob indicators off and on.
- prev:** Selects the previous source input.
- next:** Selects the next source input.

Note: Preamplifier or integrated amplifier program mode can be selected from the R-com by pressing and holding the **pre** key. Program mode functions can then be accessed from the equipment front panel.

In Tuner mode (press **tun** key) the following keys will change function:

- disp:** Switches the tuner display and front panel button indicators off and on.
- prev:** Selects the tuner "down" function.
- next:** Selects the tuner "up" function.

Note: Tuner modes can be selected from the R-com by an extended press of the **tun** key.

15.2 R-com Keys

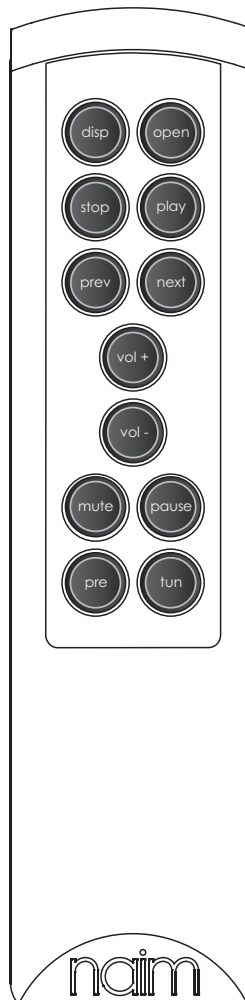

NARCOM 4 Remote Handset

16 NARCOM 4 Remote Handset

The Narcom 4 remote handset is supplied with all preamplifiers. It is a multi-functional remote control handset designed to be used with Naim Audio CD players, integrated amplifiers, preamplifiers, and preset tuners.

To fit the remote handset batteries, remove the battery cover by pressing the small button located on the rear of the handset body. Remove the cover and insert the batteries into the body taking care with their orientation. Replace the battery cover.

16.1 Using NARCOM 4

Operation of the Narcom 4 handset is based around three types of keys: **System Component Keys**, **Global Keys** and **Soft Keys**.

System Component Keys switch the operation of the **Soft Keys** into modes appropriate to each system component (CD player, preamplifier, etc.).

Global Keys operate specific component functions regardless of the **System Component Key** setting and are available at all times.

Preamplifier and Integrated Amplifier **Global Keys** operate as follows:

vol (▲ & ▼) Adjusts the preamplifier volume and the volume control position.

mute Reduces the preamplifier volume to zero. A second press restores the volume.

bal (◀ & ▶) Adjusts the channel balance. Some Naim amplifiers have control of channel balance available only from the remote handset. On these products the balance will automatically centre as it reaches the mid point. Centring is indicated by a flashing volume control indicator. To resume adjustment once the balance has centred, the **bal** key must be released and re-pressed.

mon Enables the output of a recording device to be heard while recording. The source to be recorded is chosen by the input selection buttons in the normal way. A second operation of the **mon** key restores normal operation. **Mon** alternatively operates the mono function on appropriately equipped preamplifiers.

Preamplifier **Soft Keys** operate as follows:

disp Switches the front panel button indicators off and on.

prog Press and hold to switch the preamplifier into program mode.

numeric Enables direct selection of source inputs.

16.2 NARCOM 4 Keys

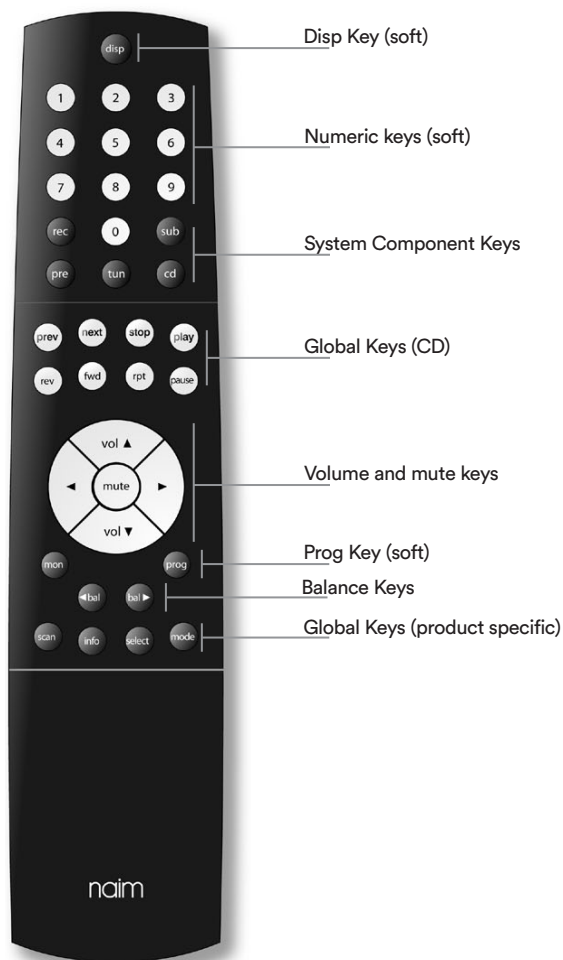

Declaration of Conformity

17 Declaration of Conformity

Naim Audio declares that Naim Audio products are in conformance with:

Low Voltage Directive 2006/95/EC
Electromagnetic Compatibility Directive 2004/108/EC
Restriction of Hazardous Substances (RoHS2) Directive 2011/65/EU
Waste of Electrical and Electronic Equipment Directive 2002/96/EC
Energy Related Products (ErP), Directive 2009/125/EC

Naim Audio products comply with the following standards:

EN60065 - Audio, video and similar electronic apparatus - Safety requirements
EN55013 - Sound and television broadcast receivers and associated equipment - Radio disturbance characteristics
EN55020 - Sound and television broadcast receivers and associated equipment - Immunity characteristics
EN61000-3-2 - Mains harmonics current emissions
EN61000-3-3 - Mains flicker emissions

18 Statutory Safety Warnings

In order to comply with current European safety regulations it is essential that the Naim loudspeaker connectors supplied with amplifiers and loudspeakers are used.

Do not under any circumstances allow anyone to modify your Naim equipment without first checking with the factory, your retailer, or your distributor. Unauthorised modifications will invalidate your guarantee.

Equipment must not be exposed to dripping or splashing and no objects filled with liquid, such as vases, should be placed on the equipment.

For your own safety do not under any circumstances open Naim equipment without first disconnecting it from the mains.

Warning: an apparatus with CLASS I construction shall be connected to a mains socket outlet with a protective earthing connection.

Warning: batteries installed shall not be exposed to excessive heat such as sunshine, fire or the like.

Where the mains plug or an appliance coupler is used as the disconnect device, the disconnect device shall remain readily operable. To disconnect the equipment from the mains remove the mains plug from the mains outlet.

The following label is attached to all mains powered equipment:



This equipment has been tested and found to comply with the relevant EMC and Safety Standards, and, where applicable, also complies with the limits for a class B digital device, pursuant to Part 15 of the FCC Rules.

These limits are designed to provide reasonable protection against harmful interference in a residential installation. This equipment generates, uses and can radiate radio frequency and, if not installed and used in accordance with the instructions, may cause harmful interference to radio communications. However, there is no guarantee that interference will not occur in a particular installation. If this equipment does cause harmful interference to radio or television reception, which can be determined by turning off and on, the user is encouraged to try to correct the interference by one or more of the following measures:

- Reorient or relocate the receiving antenna.
- Increase the separation between the equipment and the receiver.
- Connect the equipment into an outlet on a circuit different from that to which the receiver is connected.
- Consult your Naim retailer or an experienced radio/TV technician for help.

Note

To the fullest extent permitted by applicable law, Naim Audio Ltd. disclaims all liability for any loss or damages whether real, incidental or consequential that arise from using this product. Naim Audio Limited, its agents and representatives, cannot be held responsible for the loss of any data or content from a Naim/NaimNet server, however caused.

Naim Audio Limited, Southampton Road,
Salisbury, England SP1 2LN
Tel: +44 (0) 1722 426600 Fax: +44 (0)871 230 1012
W: www.naimaudio.com
Part No. 12-001-0231 Iss. 1i

Products that display the crossed-out wheeled bin logo cannot be disposed of as domestic waste. These products must be disposed of at facilities capable of re-cycling them and appropriately handling any waste by-products. Contact your local authority for details of the nearest such facility. Appropriate recycling and waste disposal helps conserve resources and protects the environment from contamination.

