

MICRO

OWNER'S GUIDE



CONTENTS

- 4 INTRODUCTION
- 5 OPTIONAL ACCESSORIES AND MOUNTS
- 6 INITIAL SET UP
- 7 DETAILED SET UP
- 8 PLACEMENT OF SPEAKERS
- 9 SPECIFICATIONS AND WARNING
- 10 TECHNICAL SUPPORT AND WARRANTY

INTRODUCTION

Thank you for choosing Gallo Acoustics loudspeakers.

Please take the time to read and understand this guide thoroughly before installing your loudspeakers. This will ensure that you achieve optimal performance without the risk of causing damage to your speakers or amplifier.

RUN-IN PERIOD

Your Gallo loudspeaker utilises proprietary technologies that only reach their optimum performance levels after a period of 60 - 80 hours of use. During this run-in process the loudspeaker driver will loosen-up, the patented S2 fill material will settle, and your loudspeakers will develop the acoustic characteristics that are our signature.

BOX CONTENTS

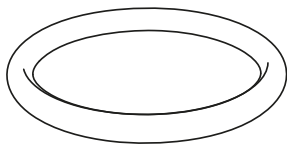

1 x ISOLATION RING

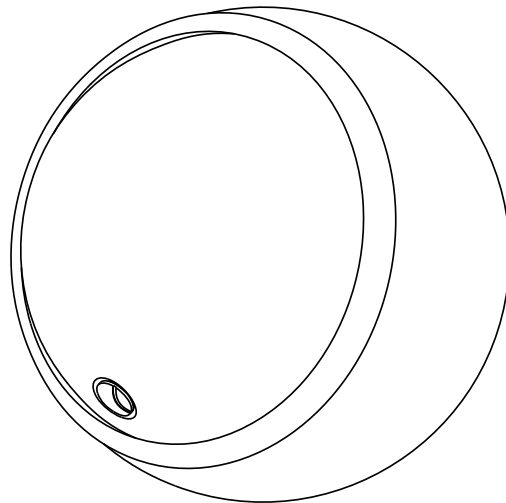

1 x MICRO LOUDSPEAKER

OPTIONAL ACCESSORIES

Available from your dealer, or directly from www.galloacoustics.com

WALL MOUNT

The Wall Mount is compatible with all Micro and A'Diva loudspeakers, and is available in Black, White and Stainless Steel finishes. Speaker cable can pass through the mount, allowing for a neat installation.

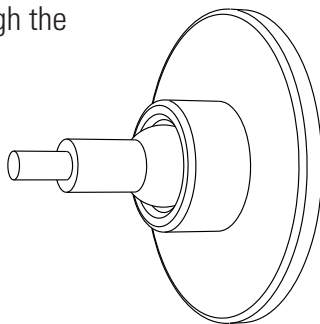

FLOOR STAND

The Micro Floor Stand is ideal for situations where a suitable mounting position cannot be achieved by wall or surface mounting. The stand is available in Black, White and Stainless Steel finishes. Speaker cable can be hidden within the stem itself, so the clean elegant look is not compromised.

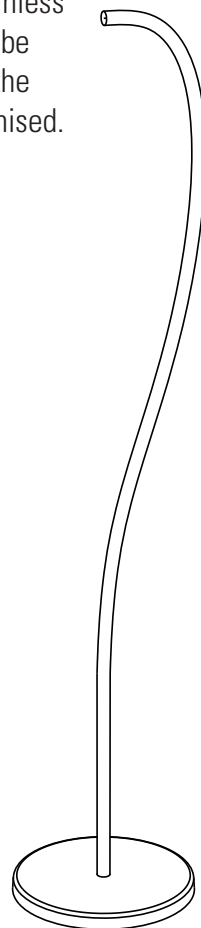

IN-CEILING MOUNT

Specific versions of the In-Ceiling Mount are available for Micro and A'Diva loudspeakers. The outer ring can be painted to match either the speaker finish or the ceiling colour, adding to the appeal - furthermore, the sound can be tailored to the room by angling the speakers towards the listening position.

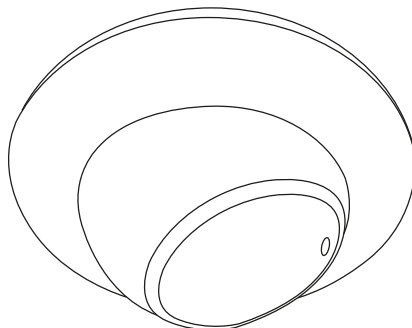

INITIAL SET UP

Please ensure that your amplifier is turned off before connecting the loudspeakers. When connecting speaker cables to your loudspeakers and amplifier, ensure that correct polarity is observed - red (+) terminal on the speaker to the red (+) terminal on your amplifier, black (-) terminal on the speaker to the black (-) terminal on your amplifier.

In either stereo or multi-channel systems, Micro loudspeakers are designed to be used in conjunction with a subwoofer, so the full frequency image can be heard.

Gallo Acoustics subwoofers are specifically designed to compliment the sound of your loudspeakers and have built-in crossovers, allowing full frequency control whilst protecting the speakers.

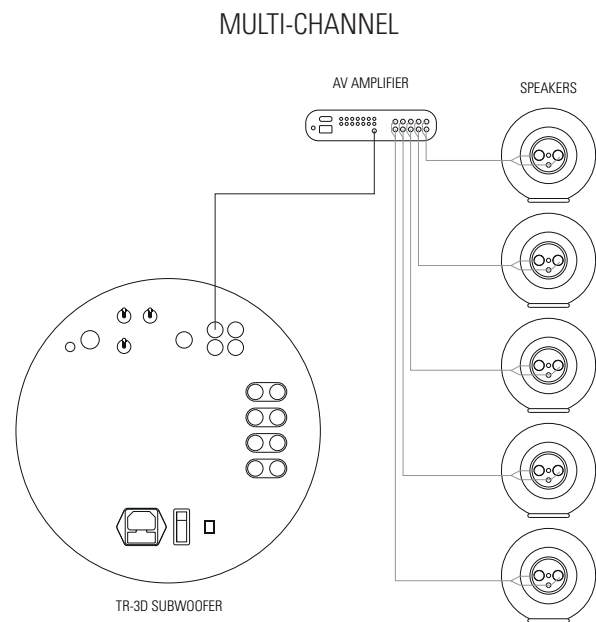
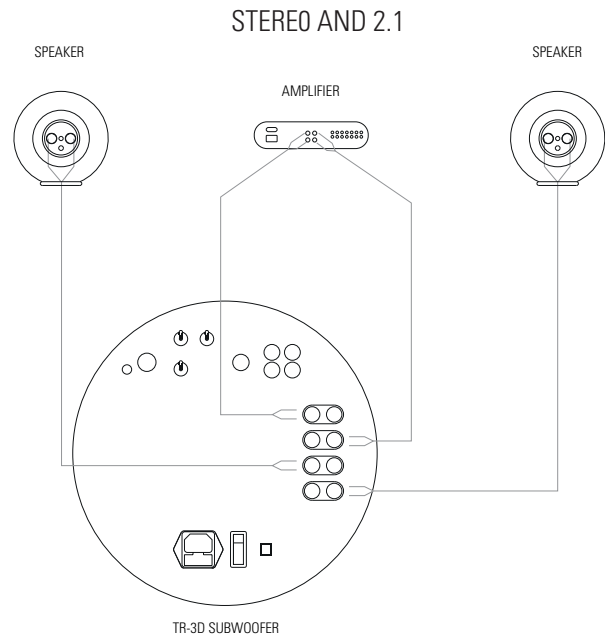

STEREO AND 2.1

When using Micro loudspeakers in a stereo or 2.1 system, you must employ a suitable crossover or filter to ensure that only frequencies of 80Hz and above are sent to the loudspeakers. Attempting to playback lower frequencies can cause permanent damage to the loudspeaker and invalidate the warranty.

- Using speaker cables, connect the speaker outputs on your stereo amplifier to the high level inputs on the subwoofer.
- Run a second set of speaker cables from the high level outputs on the subwoofer to your Micro loudspeakers.
- On the subwoofer adjust the crossover to around 100hz.
- When music is playing, you can adjust the level control to match the subwoofer and Micro loudspeaker volume.

Consult your subwoofer owner's guide for more detailed set up instruction.

MULTI-CHANNEL AND HOME CINEMA

When using a multi-channel surround sound system, first ensure that you are familiar with your amplifier's functions, to ensure that the correct mode and settings are applied.

- Using speaker cables, connect the speaker outputs from your AV Amplifier to the Micro loudspeakers, ensuring that each channel go to the relevant Micro speaker.
- On the AV Amplifier, select a small speaker setting, or manually set the crossover point to approximately 100hz.

Consult both your subwoofer and AV Amplifier owner's guides for more detailed set up instructions.

PLACEMENT OF SPEAKERS

The placement of loudspeakers within a room can have a great effect on the sound of the system - small changes can make significant improvements.

- When speakers are placed on the included Isolation Ring, ensure that they sit near the front edge of the surface to prevent any diffraction effect, where the sound bounces off the surface itself.
- The distance from the listening position to the loudspeakers should not be less than the distance between the speakers.
- In a multi-channel system, place the front channels about 1m to 2m apart depending on the room size and listening position.
- For the best possible performance, mount the speakers at ear height - however in most situations this is not possible, instead angle the speakers towards the listening position.

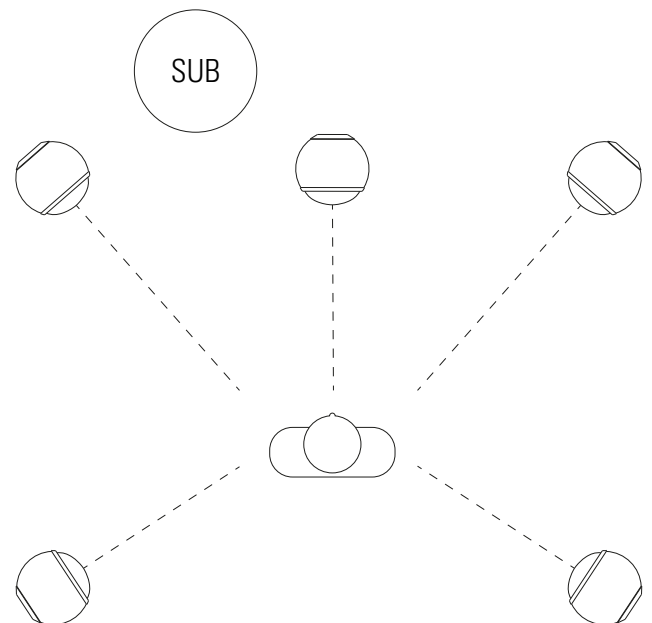
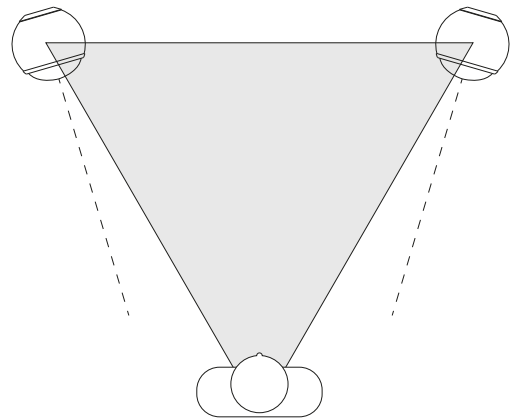

SPECIFICATIONS

Frequency Response	100hz to 18khz
Sensitivity	89 dB
Nominal Impedance	8 Ohms
Power Handling	Crossover - 100 Watts
Crossover	None
Driver	3" full range
Dimensions	10.2cm (4") diameter sphere
Weight	795g
Cone Material	Mical Polypropylene Compound
Enclosure Material	Mild Steel/Stainless Steel
Warranty	5 years

WARNING

Care must be taken when installing, mounting or standing this product to walls, ceilings or surfaces.

Appropriate fasteners must be used (where required) to ensure the safe installation of both the speakers and mounts.

If you are in any way unsure of the correct installation, assembly or use then please consult qualified sources before taking unnecessary risks.

The manufacturer, distributor or their agents cannot be held responsible for any injury as a result of improper use or installation of this product.

TECHNICAL SUPPORT

Should you encounter problems using this product, please contact your dealer or local distributor.

You can call Gallo Acoustics directly for technical support on the following numbers:

UK
01555 666883

Outside UK
+44 1555 666883

United States, Canada and South America
866 427 3873

Alternatively, email -
support@galloacoustics.com

WARRANTY

Anthony Gallo Acoustics Ltd warrants to the end user that this product will be free from defects in materials and workmanship in the course of normal use for a period of five years from the date of purchase. This guarantee covers breakdowns due to manufacturing faults and does not apply in cases such as accidental damage, general wear and tear, user negligence, modification or repair not by Anthony Gallo Acoustics Ltd.

To register your purchase please visit -
www.galloacoustics.com

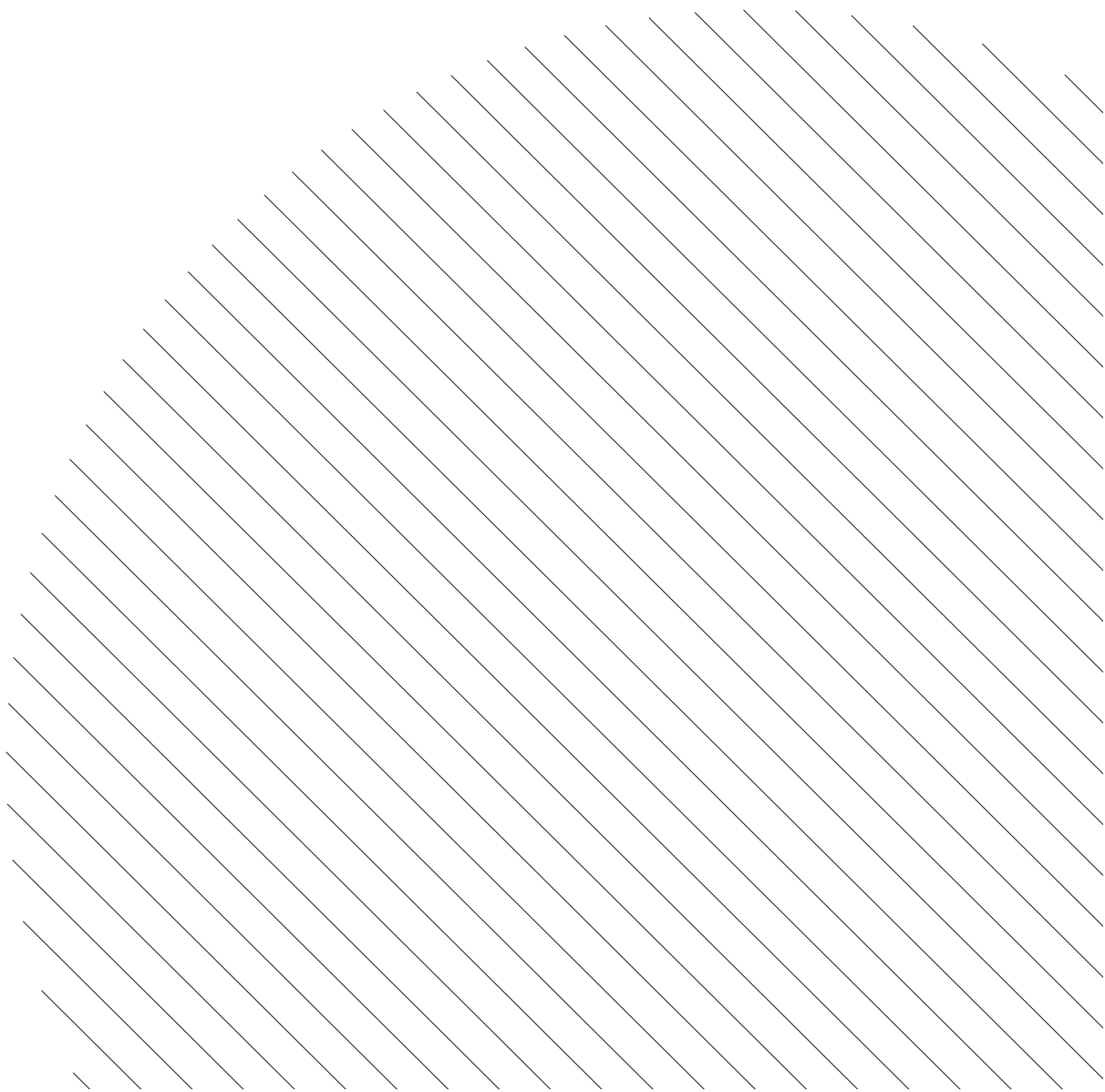



ANTHONY GALLO ACOUSTICS LTD
THE INOX BUILDING
CALDWELLSIDE
LANARK
SCOTLAND
UNITED KINGDOM
ML11 7SR

WWW.GALLOACOUSTICS.COM
