

CHRONOSONIC™ XVX

INSTALLATION AND CARE GUIDE

Wilson Audio® is a registered trademark of Wilson Audio Specialties, Inc.

Sophia®, Sasha W/P®, WAMM Master Chronosonic®, WAMM®, Alexandria®, Alexx®, Sabrina®, Alida®, Alexia®, XLF®, TuneTot®, and Thor’s Hammer®, are registered trademarks of Wilson Audio Specialties, Inc.

WAMM Master Subsonic™, Chronosonic XVX™, Sasha DAW™, WilsonGloss™, Wilson Audio Duette™, WATCH Center™, WATCH Surround™, and WATCH Dog™, are trademarks of Wilson Audio Specialties, Inc.

This manual was produced by the Wilson Audio Engineering and the Marketing Department. The information contained herein is subject to change without notice. Current Revision 1.0. If you are in need of a more recent manual, please contact your dealer or download one at www.wilsonaudio.com.

The information in this manual is the sole property of Wilson Audio Specialties, Inc. Any reproduction, in whole or in part, without the express written permission of Wilson Audio Specialties, Inc., is prohibited. No material contained herein may be transmitted in any form or by any means, electronic or mechanical, for any purpose, without the express written permission of Wilson Audio Specialties, Inc.

Copyright © 2019 Wilson Audio Specialties

CONTENTS:

SECTION 1—CONTENTS AND STAGING..... 5

 SECTION 1.1—CHRONOSONIC XVX CRATE CONTENT 6

 SECTION 1.2—STAGING THE CHRONOSONIC XVX 6

 ORGANIZE THE MODULES BY CHANNEL..... 7

 SECTION 1.3—WASP 8

 ZONE OF NEUTRALITY..... 8

 SPEAKER PLACEMENT VERSUS LISTENING POSITION 11

 SPEAKER ORIENTATION 12

SECTION 2—ASSEMBLY 15

 SECTION 2.1—PREPARATION..... 16

 GENERAL DESCRIPTION 16

 SECTION 2.2—CHRONOSONIC XVX AND THE TIME DOMAIN 17

 OPTIMIZING PROPAGATION DELAY IN YOUR ROOM 17

 SECTION 2.3—CONFIGURING THE LOWER SUBMODULE..... 19

 SECTION 2.4—CONFIGURING THE UPPER SUBMODULE 21

 SECTION 2.5—INSTALLING THE GANTRY ONTO THE WOOFER MODULE 22

 INSTALLING THE GANTRY 22

 SECTION 2.6—CHRONOSONIC XVX SONOS-1 LIGHTING SYSTEM 23

BATTERY RECYCLING OR DISPOSAL..... 25

SECTION 2.7—INSTALLING THE UPPER MODULES INTO THE GANTRY 26

 INSTALLING THE LOWER SUBMODULE INTO THE GANTRY 26

 INSTALLING THE TWEETER MODULE INTO THE GANTRY 29

 MOUNTING THE UPPER MIDRANGE MODULE 30

SECTION 3—CONNECTING THE MODULES 33

 SECTION 3.1—DRESSING THE CABLES 34

 CONNECTING THE LOWER SUBMODULE 34

 CONNECTING THE UPPER SUBMODULE 36

SECTION 4—FINAL SETUP..... 39

 SECTION 4.1—SPIKE INSTALLATION 40

 SPIKE ASSEMBLY..... 40

 SECTION 4.2—USING THE WILSON LIFT TO INSTALL SPIKES 40

 MATERIALS REQUIRED 40

 INSTALLATION PROCEDURE..... 41

 LEVELING THE CHRONOSONIC XVX 42

 SECTION 4.3—REMOVING THE PROTECTIVE FILM..... 43

 SECTION 4.4—RESISTORS..... 44

 MIDRANGE AND TWEETER RESISTORS 45

 WOOFER DAMPING RESISTOR..... 45

 RESISTOR FINE TUNING 46

 SECTION 4.5—ADJUSTING THE CHRONOSONIC XVX'S XLF PORT..... 47

 CHOOSING A PORT CONFIGURATION..... 47

 REVERSING THE PORT PLUG 48

 SECTION 4.6—THE REAR TWEETER MODULE ATTENUATOR 48

SECTION 5—SPECIFICATIONS 51

 SECTION 5.1—SPECIFICATIONS 52

 SECTION 5.2—GRAPHICAL DIMENSIONS..... 53

 SECTION 5.3—IMPEDANCE PHASE..... 54

 SECTION 5.4—IMPEDANCE MAGNITUDE..... 55

SECTION 6—TIME ALIGNMENT CHARTS 57

 TIME ALIGNMENT CHARTS 58

SECTION 7—WARRANTY 65

 SECTION 7.1—LIMITED WARRANTY 66

 SECTION 7.2—CONDITIONS 66

 SECTION 7.3—REMEDY 67

 SECTION 7.4—WARRANTY LIMITED TO ORIGINAL PURCHASER 68

 SECTION 7.5—DEMONSTRATION EQUIPMENT 68

 SECTION 7.6—MISCELLANEOUS 69



SECTION 1—CONTENTS AND STAGING

Section 1.1—Chronosonic XVX Crate Content

Please take the time before you attempt to set up your Chronosonic XVX to review the contents of your Chronosonic XVX tool and spike kit. Set these items in an accessible area as you will need them during the setup process. See the two graphics below:

Section 1.2—Staging the Chronosonic XVX

Note: To avoid damaging the XVX's painted surface. Please remove any jewelry such as rings, watches, necklaces, and bracelets during this process.

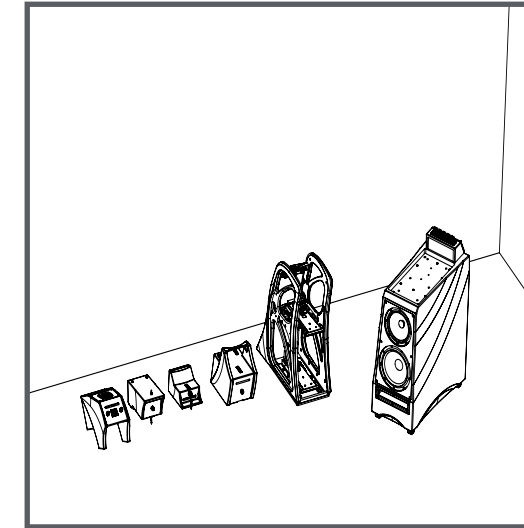
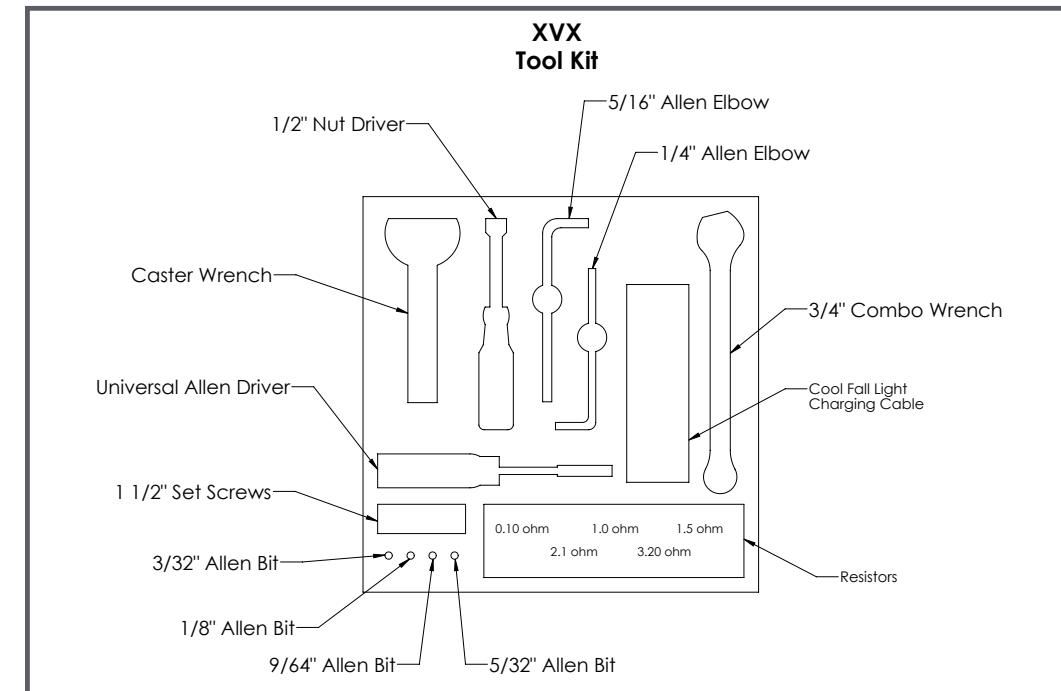

elery such as rings, watches, necklaces, and bracelets during this process.

Organize the Modules by Channel

It is extremely important the XVX be assembled with elements assigned to each channel. Each of the modules are labeled with a serial number. To start the process of ensuring that each of the modules and the Chronosonic XVX Gantry is assembled in its appropriate channel, Wilson recommends that the modules are separated and organized by channel according to serial number. Stage the

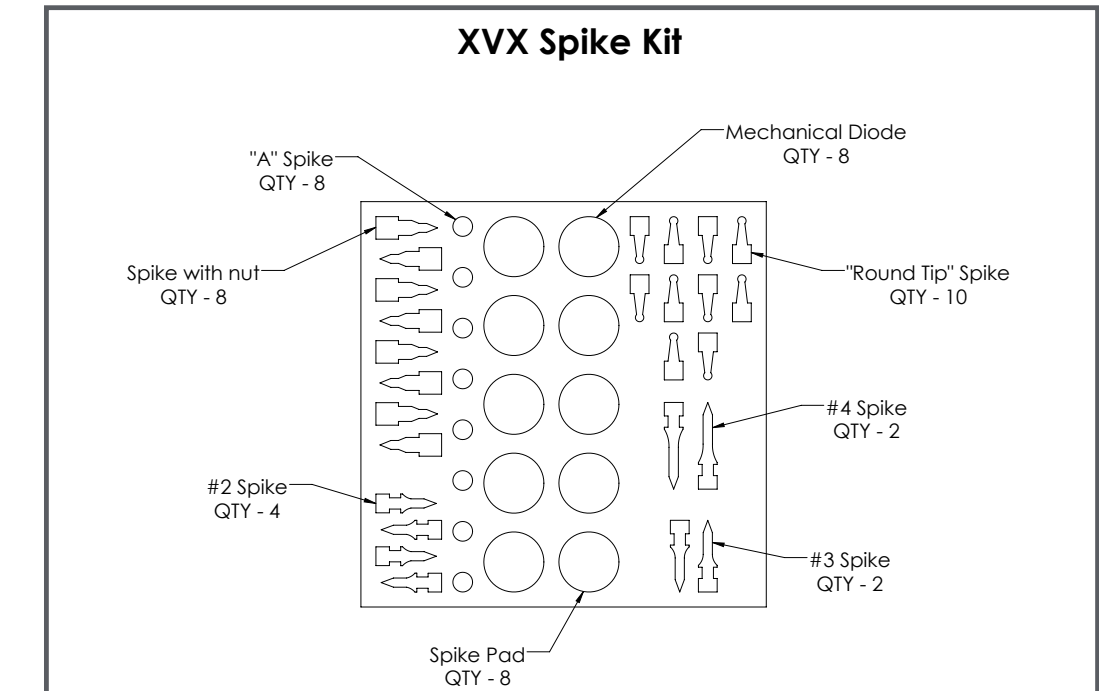

elements for the odd-numbered modules on the left, and the even on the right.

As the modules are removed, stage them as illustrated on the previous page.

Section 1.3—WASP

An instructional video outlining the Wilson Audio Setup Procedure (WASP) can be found here: www.wilsonaudio.com/WASP. The proper positioning of your new Chronosonic XVX within your room is critical in order to extract its formidable performance envelope. When carefully followed, the WASP has proven to be the most effective method for setting up Wilson loudspeakers. Your authorized Wilson dealer is trained in this process, and is the best resource for you to ensure your loudspeakers are set up properly.

Viewing the video is the best way to learn how to properly employ WASP, but we have also included an outline of it here.

Zone of Neutrality

It is important that the instructions in the following section are carried out precisely. The Chronosonic XVX is a precision instrument, capable of extremely accurate alignment in the time domain if the following process is meticulously followed.

You will need the following items:

- Supplied hardware kit

- Tape measure
- Known listening position
- Masking Tape

The “Zone of Neutrality” is an area in your room where the speakers will sound most natural. This location is where the speakers interact the least with adjacent room boundaries. It is important to have a clear working space while determining the Zone of Neutrality.

The following is a simple method to locate the Zone of Neutrality within your listening environment:

1. Stand against the wall BEHIND the location where you intend to position your loudspeakers. Speaking in a moderately loud voice and at a constant volume, project your voice out into the room. Your voice will have an overly heavy, “chesty” quality because of your proximity to the rear wall.
2. While speaking, slowly move out into the room, progressing in a direction parallel to the sidewall. It is helpful to have another listener seated in the listening position to assist you during this process. Listen to how your voice “frees up” from the added bass energy imparted by the rear wall boundary. Also notice that your voice is quite spatially diffuse (to your assistant, your voice will sound spatially large and difficult to localize) as you begin to ease away from the rear wall.

3. At some point during your progression forward into the room, you will observe a sonic transition in your voice; it will sound more tonally correct and less spatially diffuse (your assistant can now precisely localize the exact origin of your voice). When you hear this transition, you have entered the inner edge of the Zone of Neutrality. Place a piece of tape on the floor to mark this location. Although it will vary from room to room, in most rooms the zone begins between two and a half to three feet from the rear wall.
4. Continue to walk slowly away from the rear wall. After some distance, usually one to two feet past the first piece of tape, you will begin to hear your voice lose focus and appear to reflect (echo) in front of you. This is caused by the return of the room's boundary contribution; your voice is now interacting with the opposite wall. At the point where you begin to hear the reflected sound of your voice, you have reached the outer edge of the Zone of Neutrality. Place a piece of tape on the floor and mark this location. The distance between the "inner" and "outer" edge tape marks is usually between eight inches (for small, interactive rooms) and three feet (for large, more neutral rooms).
5. Now position yourself against the side wall perpendicular to

the intended speaker location. Stand between the two tape marks. Using the same procedure as above, begin moving into the room toward the opposite sidewall, progressing between the two pieces of tape. As above, listen for the point in the room where your voice transitions from bass-heavy and diffuse to neutral. Mark this point with tape. Continue your progression until there is an obvious interaction with the opposite wall in front of you and mark this point with tape. The four pieces of tape now form a rectangle that establishes the Zone of Neutrality for the loudspeaker to be installed on that side of the room. Using the four marks as your guide, tape an outline to define the boundaries of the rectangle.

6. Repeat this process for each speaker location individually. These are your Zones of Neutrality, one for each channel.

Theoretically, the Zone of Neutrality for any room runs like a path, parallel to the walls all around the room. Adjacent to very large windows and open doors, the outer edge of the Zone of Neutrality moves closer to the wall and becomes wider. If you were to extend the inner and outer boundaries of the Zone for the sidewalls and the front wall (behind the speakers), they would intersect.

Speaker Placement Versus Listening Position

The location of your listening position is as important as the careful setup

of your Wilson Audio loudspeakers. The listening position should ideally be no more than 1.1 to 1.25 times the distance between the tweeters on each speaker. Therefore, in a long, rectangular room of 12' x 18', if the speaker tweeters are going to be 9' apart, you should be sitting 9'11" to 11'3" from the speaker. This would be more than halfway down the long axis of the room.

Many people place the speakers on one end and sit at the other end of the room. This approach will not yield the finest sound. Carefully consider your listening position. Our experience has shown that any listening position that places your head closer than 14" from a wall will diminish the sonic results of your listening due to the deleterious effects of boundary interaction.

Speaker Orientation

Speaker placement and orientation are two of the most important considerations in obtaining superior sound. The first thing you need to do is eliminate the sidewalls as a sonic influence in your system. Speakers placed too close to the sidewalls will suffer from a strong primary reflection. This can cause out-of-phase cancellations, or comb filtering, which will cancel some frequencies and change the tonal balance of the music. Adhering to the Wilson Audio Setup Procedure outlined in the previous section is the best method with which to position your loudspeakers.

A very important aspect of speaker placement is how far from the back wall to place the speakers. The closer a loudspeaker is to the back wall, the more pronounced the low bass energy and centering of the image will be. However,

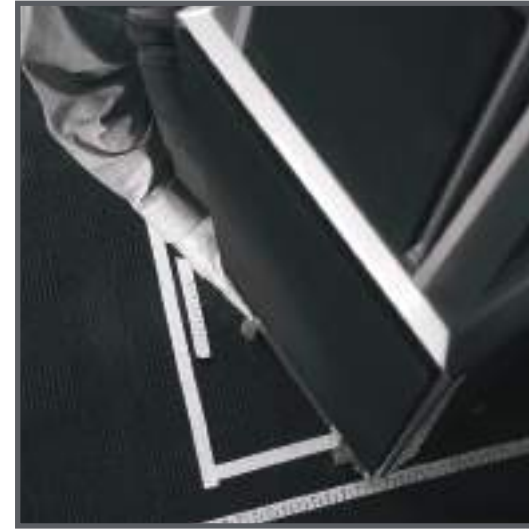

this comes at a definite reduction in stage size and bloom as well as a deterioration of upper bass quality. You must find the proper balance of these two factors, but remember, if you are partial to bass response or air and bloom, do not overcompensate your adjustments to maximize these effects. Overcompensated systems are sometimes pleasing in the short-term, but long-term satisfaction is always achieved through proper balance.

To make correct in-home set up of the Chronosonic XVX possible without test equipment, Wilson Audio has measured the correct geometric time domain alignment for different distance/ear height combinations. See the next section for details. By measuring the distance from the bottom-front baffle of your speaker to your ear when seated in the listening position, as well as height of the listener's ear measured from the floor, you will be able to align the system for your listening position.



SECTION 2—ASSEMBLY

Wilson Audio Specialties

Section 2.1—Preparation

General Description

The Chronosonic XVX's Upper Array uses the combination of captive spikes, ball posts, and aspherical time-alignment stepped blocks. The spike/block combination rotate the two upper submodules to a prescribed position as a part of the Chronosonic XVX's propagation delay adjustment.

Additionally, the spikes in the modules provide proper coupling of the upper modules to the Gantry. Some of these spikes are fixed in size. The shorter "A" spikes are always installed in the front two positions of the bottom of the 4-inch midrange module. In the Tweeter Module, the "A" spikes are installed in the top surface of the module, pointing upward toward the upper-midrange module above. Ball posts are installed into the bottom front of the Tweeter Module, and into the top rear of that module. The ball posts are installed into the bottom two front receptacles of the Lower Midrange Module.

For the bottom rear of the Tweeter Module as well as the Lower Midrange Module, a different-length spike is used rotate the two submodules in order to optimize the dispersion of the array. The spike-type is stamped into the flat surface on the top of each spike. The spikes should be screwed in all the way, until they are hand tight, then 1/16" further to tighten into place.

The Upper Midrange Module and the Tweeter Module form a submod-

ule, which is moved in tandem using the XVX Micrometer system. Similarly, the 4-inch Midrange Module and the Lower Midrange Module form a submodule, which is moved by its corresponding XVX Micrometer system. These two submodules are, in turn, attached to the XVX Micrometer truck mechanism via a ball-head and captive slot system. The ball-head hardware is attached into the threaded receptacle located on the bottom front of the Tweeter Module and the Lower Midrange Module respectively.

Section 2.2—Chronosonic XVX and the Time Domain

Optimizing Propagation Delay in Your Room

The Chronosonic XVX system allows optimization for different listening distances and listening ear heights. In order to calculate the proper time-domain settings for the upper modules, the distances from the listener's ear to the front, lower baffle of the XVX (see graphic on the next page), and the distance from the floor to the listener's ear must be accurately measured. For each distance/ear height combination there is a unique alignment geometry.

1. Refer to the Time Alignment Charts in Section 6. Time Alignment Tables for all Wilson loudspeakers are also available on the Wilson Audio's website.
2. Make sure that you are in your intended listening position.



3. While sitting, have someone measure your ear height from the floor directly below your ear canal. You should be relaxed in your chair, as you would be when listening to music.
4. Now measure the distance (on the floor) from the point on the floor below your ear to the base of the loudspeaker.
5. There are four charts for the lower submodule, which consist of settings for both the Lower Midrange Module and the 4-Inch Midrange Module as well as the proper Micrometer setting. The first chart, labeled “XVX Lower Array Alignment Block Step,” specifies the step on which the lower-midrange module’s rear spike will



rest. The second, “XVX Lower Midrange Spike Length,” determines the rear spike length for the lower submodule. The third, “XVX Lower 4-Inch Detent Position,” specifies the position of the front right spike into the detent on the top of the smaller 4-inch Midrange Module. The fourth is named “XVX Lower Module Chronosonic Micrometer Position.” This indicates the precise position of the lower submodule in the Gantry as adjusted by the Chronosonic XVX Micrometer.

6. There are four charts for the upper submodule. The first, labeled “XVX Upper Tweeter Detent Position,” specifies the position of the spike detent for the tweeter. The second, labeled “Tweeter Module Spike Length”, indicates which spike to install in the rear of the upper module. The third labeled “XVX Tweeter Alignment Block Step,” specifies the step on which the upper-midrange module’s rear spike will rest. The fourth is named “XVX Upper Module Array Chronosonic Micrometer Position.” This indicates the position of the upper submodule in the Gantry as adjusted by the Chronosonic XVX Micrometer.

Section 2.3—Configuring the Lower Submodule

Note: This is a good time to remove the protective “frisk” from the surface of the painted enclosure. Refer to the instructions in section 4.3.

Note: This part of the install process must be completed before you install the modules into the Gantry.

1. Refer to the chart in Section 6 called “XVX Lower Midrange Module Spike Length.” Using the measured ear height and speaker distance, refer to the intersecting box in the chart. If there is a number in the converging box, the Chronosonic XVX Lower Midrange Module requires a spike. The spike number is stamped into the flat surface at the top of the spike. From the toolkit, locate the required spike, and install it into the rear spike receptacle on the bottom of the module.
2. At the same time, install the two ball-end spikes into the front receptacles of the Lower Midrange Module.
3. The 4-Inch module installs into the captive, winged receptacle on the upper portion of the Lower Midrange Module. Install the “A” spikes into its front receptacles. An oval-topped tension spike is pre-installed into the rear shelf of the 4-inch module.
4. Refer to the table in Section 6 labeled “XVX Lower 4-inch Mid Detent Position.” This table indicates the detent location in which the right front spike rests.
5. Raise the tension spike located at the rear of the 4-inch Midrange Module such that the spike is not protruding through the bottom surface. This will enable the module to freely move



- into the Lower Midrange Module without risk of scratching the painted surfaces.
6. Install the 4-inch Module into the winged receptacle in the Lower Midrange Module.
7. The right spike track on the top surface of the Lower Midrange Module contains calibrated numbers for this process. It is necessary to adjust the 4-inch Module fore-to-aft in such that right “A” spike rests on the correct number as indicated by the chart. Locate the correct number and carefully slide the 4-inch Module such that the spike is positioned above the correct detent. Carefully tighten the rear tension spike, making sure that the front-right spike remains centered on the proper detent.
8. The lower submodule is installed into the Chronosonic XVX Gantry Array in this assembled form. Return the assembled submodule to the staged area.

Section 2.4—Configuring the Upper Submodule

1. Rest the Tweeter on a safe surface.
2. Install two “A” spikes into the top front receptacles of the Tweeter Module. Install a ball post into the top rear of the module.

3. Invert the Tweeter Module so the bottom is now facing upward. Install two the ball post spikes into bottom-front receptacles.
4. Reference the Propagation Delay Table labeled “Tweeter Module Spike Length”. Locate the corresponding ear height and listening distance for the upper-midrange module.
5. If there is number in the converging box, the Tweeter Module requires a spike. The spike number is stamped into the flat surface at the top of the spike. Locate the required spike in your spike kit, and install into the rear spike receptacle on the bottom of the module.
6. No hardware is installed into the Upper Midrange Module.

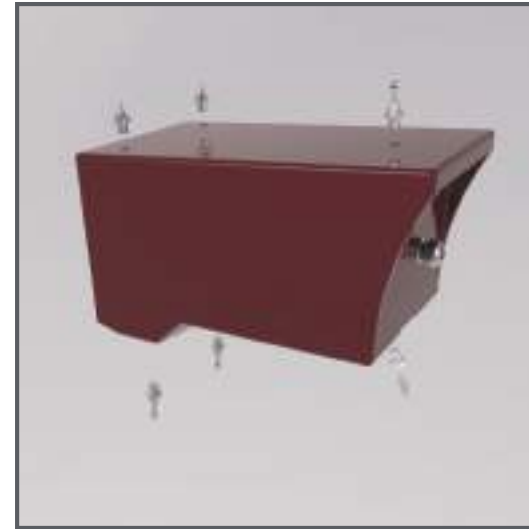

Note: The Tweeter Module and the Upper Midrange Module are installed separately into the Chronosonic XVX Gantry Array. Do not assemble the two modules at this point of the process.

7. Return both modules to the staging area.

Section 2.5—Installing the Gantry Onto the Woofer Module

Note: The Chronosonic XVX Gantry is extremely heavy. Ideally, four installers should be present for the safe installation of the Gantry to the Woofer Module.

Installing the Gantry

The Gantry is pre-assembled before shipment. The top of the Woofer Module features a recessed area within which the Gantry resides. Use the following steps to install the Gantry.

1. Lift the Gantry onto the Woofer Module. Take care to avoid damaging the painted surfaces as you guide the Gantry into its recessed receptacle.
2. There is intentionally a small amount of play within the recessed receptacle to allow for accurate installation of the Gantry. Align the six countersunk holes in the bottom plate of the Gantry with the corresponding receptacles on the top of the Woofer Module.
3. In the toolkit, locate the six (for each channel) 1/2” countersunk head bolts.
4. Using the 5/16” Allen wrench, install the six bolts securing the Gantry to the woofer.
5. Tighten to secure, but take care not to over tighten.



Section 2.6—Chronosonic XVX Sonos-1 Lighting System

The Chronosonic XVX features a lighting system to aid in the accurate installation and setup of the upper modules. The system consists of two bespoke Coolfall lights strategically located in the rear of the Gantry. The batteries feature three levels of output, which can be adjusted via the rotary switch on the front of the light. When fully charged, the batteries will power the lights for up to 80 hours on the lowest setting (1.5 lumens). On the middle setting (5 lumens), the battery will last up to 50 hours. On the highest setting (20 lumens), the battery will last up to 24 hours. There are two Coolfall light locations, one each located on the inside surface of the two cross braces located on the rear of the Gantry. Follow the steps below to charge the Coolfall's batteries.

1. The Coolfall lights are secured using spring-loaded pressure hardware and can be removed and re-installed without tools. Remove the two lights for recharging.



2. The light features two rechargeable batteries. Withing each battery is a mini-USB port for charging. Using the provided Y adapter, plug the adapter into any USB charger. Ensure the batteries are fully charged before installing reinstalling the light.
3. The lights are positioned with the adjustment knob and light facing down into the Gantry. After replacing the battery cover, gently push the light into the receptacle until it snaps into place.

Battery Recycling or Disposal

The included batteries contain lithium and must be recycled or disposed of properly. Contact your local county solid waste authority for proper recycling or disposal information.

1. Always dispose or recycle a used battery pack in accordance with prevailing local governmental regulations relating to the

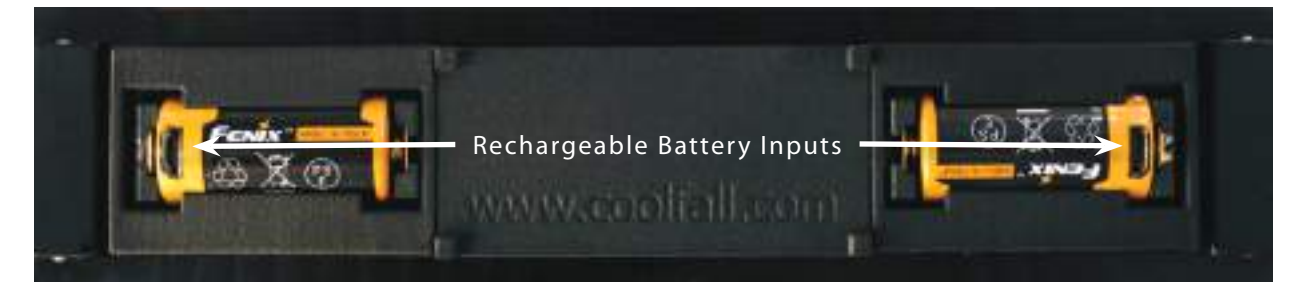

disposal/recycling of household toxic wastes.

2. Cover the metal terminals on the ends of the battery pack with insulating tape before disposal to prevent accidental short-circuiting.
3. Never dispose of a battery pack by throwing it into a fire. Battery explosion could result.
4. Never discard a used battery pack with ordinary solid wastes, since it contains toxic substances.
5. If required, return to Wilson Audio Specialties Inc. for disposal or recycling. Contact your dealer for instructions.

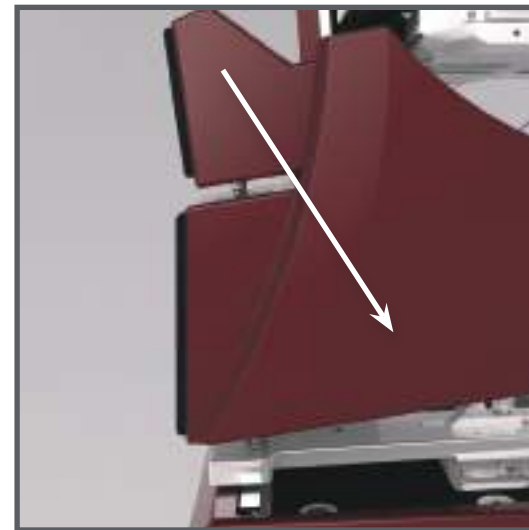

Section 2.7—Installing the Upper Modules into the Gantry

Installing the Lower Submodule into the Gantry

Note: Enlist the help of an assistant to safely install the Lower submodule, which consists of the Lower Midrange Module and the 4-inch Midrange Module, into the Gantry. The assembled submodule is quite heavy, and requires at least two experienced installers to install correctly. One installer should be positioned at the rear of the Gantry to guide the module into place. Care should be taken to avoid scratching the front woofer with the rear spike.

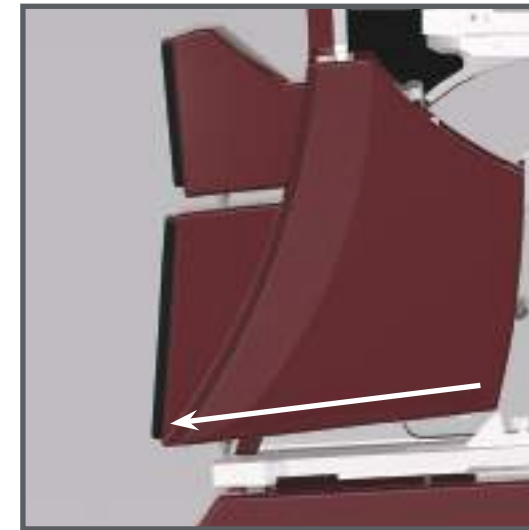

1. Turn on the two lights to aid in the setup of the modules in the Gantry.
2. Loosen the stepped block located on both the lower micrometer by rotating the knurled bolt counter-clockwise just until it slides freely fore-to-aft.
3. Unlock the upper and lower Micrometer by rotating the two oval-head locking bolts on the left side of the Micrometer.
4. The lower Micrometer adjustment knob faces upward in the rear of the Gantry. Using the knob, move the Chronosonic XVX Micrometer Lower Module assembly as far forward (toward the front of the loudspeaker) as it will go.
5. Using the upper of the two rotary knobs, found on the right side of the Gantry, move the upper Micrometer all the way to the rear of the Gantry.
6. Locate the Alignment Chart labeled “XVX Lower Array Alignment Block Step.”
7. The alignment block has numbers engraved on its right side that correspond to an assigned step. Locate the correct numbered step from the chart. The rear spike will rest on this step.
8. The module is installed from the front of the loudspeaker. Po-

sition your assistant to the rear of the Chronosonic XVX. Have your assistant reach through the Gantry assembly and support the bottom portion of the Lower Midrange Module in order to safely guide the module into position.

9. The ball-head posts insert into the slot in the front of the Micrometer. The slot features a wider section at the rear, which provides an opening for the ball.
10. Once you successfully insert the ball head into the slot opening, push the module toward the front of the loudspeaker until the ball head rests against the front of the slot.
11. Rest the rear spike on the appropriate block step. This may take some adjustment after the module is safely installed into the Micrometer.
12. Tighten the knurled knob on the stepped block.
13. Using your measurements for ear height and listening distance, refer to the chart labeled "XVX Lower Module Chronosonic Micrometer Position." Locate the Micrometer setting on the chart. There are two reference points of the Micrometer, labeled "A" and "B." The chart indicates which of these markers to use. Using the rotary dial, move the Micrometer so that it aligns with the corresponding number on the Micrometer.

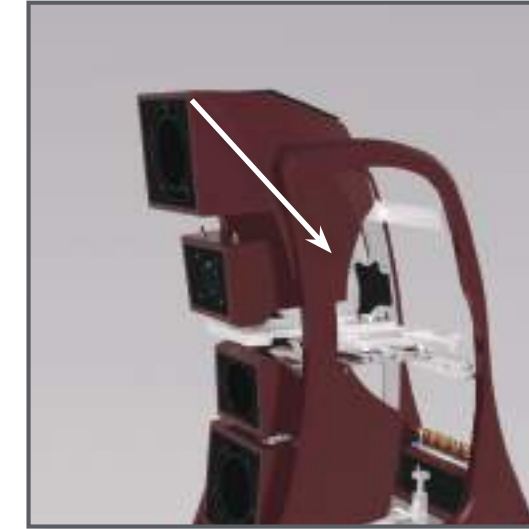
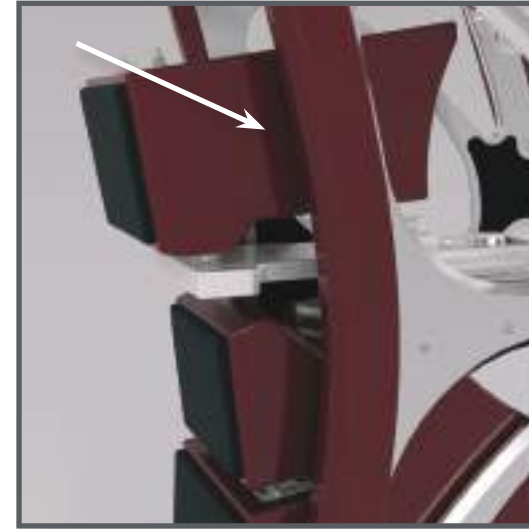

Once you've properly set the Micrometer position, use the two oval-head locking bolts located on the side of the Micrometer to secure it from further movement.

Installing the Tweeter Module into the Gantry

Note: As noted in the previous section, the Tweeter Module and the Upper Midrange Module are installed separately into the Chronosonic XVX Gantry Array. Never attempt to install or remove the Tweeter Module and the Upper Midrange Module as one unit.

1. Using the rotary dial on the side of the Gantry, move the upper Chronosonic XVX Micrometer to the farthest forward position.
2. Reference the table labeled "XVX Tweeter Alignment Block Step" in Section 6. Locate the corresponding ear height and listening distance for the Tweeter Module Step.
3. There are two slots milled into the upper Micrometer plate that serve as guide tracks for the two front ball-head spikes for the Tweeter Module. These have an opening on one end that will receive the ball tips. Carefully maneuver the module until the front two ball-end spikes settle into the tracks. Push the module until stops in the front of the ball track.
4. Locate the correct numbered step from the table and rest the

rear spike on this step.

5. Ensuring the Tweeter Module remains in the most forward position in the track, move the alignment step block and position spike on the correct step according to the time alignment charts.
6. Using your measurements for ear height and listening distance, locate the Micrometer setting on the “XVX Tweeter Module Chronosonic Micrometer Position” chart. There are two reference points of the Micrometer, labeled “A” and “B.” The chart indicates which of these markers to use. Using the rotary dial, move the Micrometer so that it aligns with the corresponding number on the chart. Once you’ve properly set the Micrometer position, used the two oval-head locking bolts located on the side of the Micrometer to secure it from further movement.



Mounting the Upper Midrange Module

Note: Enlist the help of an assistant to safely install the Upper Midrange Module into the Gantry. The module is front heavy.

1. There is a single ball-head receptacle located on the bottom rear of the Upper Midrange Module. There is also two spike tracks beneath the front side of the module.



2. Position your assistant to the rear of the Chronosonic XVX. Have your assistant prepare to balance the module and guide the ball-head posts installed on the top of the Tweeter Module into the opening of the slots on the bottom of the Upper Midrange Module.
3. Once the ball-head post has been successfully inserted into the slot, carefully rest the Upper Midrange module such that the front, upward facing spikes from the Tweeter Module aligns with the two front track slots on the bottom of the Upper Midrange Module.
4. The right spike track on the bottom surface of the Upper Midrange Module contains the calibrated numbers used for the proper alignment of this module. It is necessary to adjust the Upper Midrange Module fore-to-aft in such that right “A” spike rest on the correct numbered detent as indicated by the chart. Locate the correct number and carefully slide the module such that the spike is positioned below the correct detent.

Note: The Chronosonic XVX’s time-domain performance gives it the ability to account for time-domain deviations in even the finest amplifiers. Wilson Audio has accumulated data relating to the specific time-domain signature of a variety of amplifiers. We are always working to improve the accuracy of the loudspeaker/amplifier interface. To this end, we will continue to add amplifiers to the database. For those amplifiers already tested, we are able to provide time-domain profiles and alignment modifications. Correcting for the amplifier’s time-domain further enhances system accuracy and overall performance. Contact your Wilson Audio dealer for further details.



SECTION 3—CONNECTING THE MODULES

Section 3.1—Dressing the Cables

The Chronosonic XVX features two spring loaded cable-dressing fixtures located on the rear of the two cross braces. The two fixtures face the back of the loudspeaker, and provide secure and efficient dressing for the cables.

The Chronosonic XVX also features new breach-point hardware that also double as adjustable cable clamps. This hardware provides a gas-tight entry point for the module cable, eliminating the need for a spade/binding-post system. The breach-point hardware allows for the length of cable external to the module to be tailored for length. Along with the obvious cosmetic benefits, proper dressing using the cable-dressing fixtures in conjunction with the adjustable cable clamp system reduces deleterious magneto constriction.

Follow these steps to properly dress the cables.

Connecting the Lower Submodule

1. On the upper portion of the Woofer Module, locate the connector plate with a series of labeled sets of color-coded binding posts. These connectors correspond with color-coded cables attached to each module.
2. The tensioner for the two cable-dressing fixtures, which holds the cable in place, is spring loaded. Lifting the



spring-loaded back of fixture reveals a gap in the fixture big enough to insert the cable.

3. Starting with the Lower Midrange Module, feed the cable exiting the adjustable breach-point wire clamp from the module up over the lower cross brace. Drape the cable over the cross brace.
4. Slightly loosen the breach-point adjustable cable clamp on the rear of the Lower Midrange module. Using the lower connector plate as your guide, shorten the cable by pushing the slack back into the module such that there is just enough cable to safely and successfully connect it to its corresponding binding post. (A little slack is desirable.)
5. Re-tighten the adjustable breach-point cable clamp.

Note: It is extremely important to ensure the adjustable cable clamps are tightened. Failing to tighten the clamp compromises the gas-tight seal of the module.

6. After you have successfully shortened the exposed cable, gently pull back on the lower cable-dressing fixture. You will see two opposing half-ovals one on the left, and another on the right. Also, notice a series of slots in the center of the fixture. Feed the cable through the right-most slot and release the fix-

ture, ensuring the cable remains in the circular slot.

7. Attach the Lower Midrange Cable to the binding post color-coded and labeled "Lower 7" Mid."
8. Repeat this process for the 4-inch Midrange Module, this time feeding the cable through the left-most slot on the cable dressing fixture. Attach the 4-inch Midrange Cable to the binding post labeled 4" Mid.
9. Tighten the adjustable cable clamp on the back of the module.



Connecting the Upper Submodule

10. Starting with the Tweeter Module, feed the cable exiting the adjustable wire clamp from the module up over the upper cross brace. Drape the cable over the cross brace.
11. Slightly loosen the adjustable breach-point cable clamp on the rear of the Tweeter Module by twisting it counter-clockwise. Using the connector plate as your guide, shorten the cable by pushing the slack back into the module such that there is just enough cable to safely and successfully connect it to its corresponding binding post.
12. After you have successfully shortened the exposed cable, gently pull back on the cable-dressing fixture. You will see three opposing half-oval slots in the center of the clamp. Feed the cable through the



center position of the center slot and release the fixture.

13. In turn, feed the cable through the center position of the slot within the lower clamp as well.
14. Attach the Tweeter Module Cable to the binding post labeled "Front Tweeter."
15. Repeat this process for the Upper Midrange Module, this time feeding the cable through the left-most position of the center slot on the cable-dressing fixture.
16. In turn, feed the cable through the left position of the center slot within the lower fixture as well.
17. Connect the cable to the binding post labeled "Upper 7" Mid."
18. Tighten the adjustable cable clamp on the back of the module.
19. Repeat this process for the Rear-firing Tweeter, this time feeding the cable through the right-most position of the center slot on the cable dressing fixture.
20. In turn, feed the cable through the right position of the center slot within the lower dress fixture as well.
21. Connect the cable to the binding post labeled "Rear Tweeter."
22. Tighten the adjustable breach-point cable clamp.



SECTION 4—FINAL SETUP

Wilson Audio Specialties

Section 4.1—Spike Installation

Spike Assembly

- Remove the mechanical diodes and move the nut to about two threads from the point. This will allow for greater movement when leveling the loudspeaker system.
- Screw the spikes into the diode until the nut is against the diode. Be careful that the nut does not turn while inserting and threading spikes into the diode.

Note: Do not tighten these assembled spikes. You will need to unscrew them when you level the Chronosonic XVX.

- Place the set screw into the other end of the diode with the Allen head toward the spike. This will ensure that if for any reason you have to remove your Chronosonic XVX spikes, you will be able to withdraw the set screw safely using the supplied Allen wrench. Screw the set screw into the diode until it meets the spike.
- Place the assemblies out of the traffic pattern until they are needed during the installation.



Section 4.2—Using the Wilson Lift to Install Spikes

Note: This is a two person job. Do not attempt this by yourself. The Chrono-



sonic XVX weighs over 685 LBS and may seriously injure someone if tipped over.

Materials Required

- 8 sets of assembled spikes
- The Wilson Audio Lift
- The lift socket wrench
- Swivel caster wrench

Installation Procedure

1. Slide the Wilson Audio Lift under the front of the Chronosonic XVX, centered between the casters, so that the jack's lift bolt is exposed. Place the lift plate so it is positioned about an inch behind the front facade of the Chronosonic XVX woofer enclosure.

Note: An assistant should stand to the rear of the Chronosonic XVX to steady it.

2. Attach the wrench to the lift bolt and begin to slowly raise the front of the Chronosonic XVX by turning the bolt clockwise.
3. After the front of the Chronosonic XVX is high enough (you will need approximately one and a half inches of clearance beneath

the caster), use the swivel caster wrench to loosen the casters. Remove the casters.

4. Insert and screw-in the finished spike assembly. Hand tighten only!

Note: Be very careful not to cross-thread the spikes. The base of the Chronosonic XVX is made of “X” material and can be cross threaded if installed on an angle.

5. With one person stabilizing the Chronosonic XVX, lower the Chronosonic XVX by turning the jack wrench counterclockwise. Note that the Chronosonic XVX will now sit lower in the front as the spike assembly is shorter than the caster. Use caution.

Note: It is very important, at this point, that an able assistant stabilize the front of the Chronosonic XVX until the rear spikes are attached and the unit is lowered.

6. Repeat the previous process of the caster removal/spike insertion on the opposite side of the enclosure. Then continue the process on the other channel.

Leveling the Chronosonic XVX

1. It is not necessary to use the jack to level the Chronosonic XVX.
2. There is precision bubble level installed on the rear of the up-

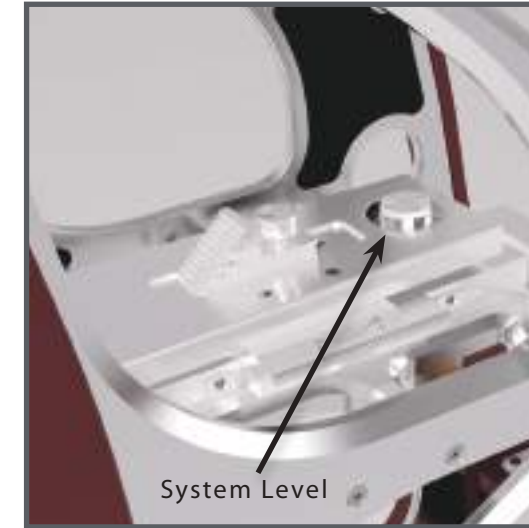

per Micrometer. Use this level to determine the loudspeaker’s level.

3. If the level is anywhere but in the general area of the center of the inscribed circle, proceed to the next step.
4. If the bubble shows that the speaker is leaning toward the center of the room, you will have to lengthen one of the inside spikes down toward the floor. If the bubble is leaning toward the outside of the room, you will have to lengthen one of the outside spikes down toward the floor.
5. Have an assistant tip the Chronosonic away from the spike in question. Lengthen the spike accordingly.
6. To find out which spike to lower, grasp the Chronosonic XVX channel and rock it back and forth. This will identify the spike that is out of level from the other three.

Place a level on the front to back oriented axis. If it is level, then your Chronosonic XVX’s are level. Using the same process as above, adjust the front or rear spikes to achieve front to back level.

Section 4.3—Removing the Protective Film

To protect the finish of the Chronosonic XVX during final manufacture,

shipment, and setup in your listening room, we have applied a removable layer of protective film over the finish. We recommend that this film be left in place until the speakers are in their final location in your listening room. Once you have determined their final position, remove the film by following this procedure:

1. Ensure the speaker surface is room temperature before removing the protective film.

Note: Removing the protective film when the speaker surface is cold can damage the paint surface.

2. Slowly remove the film from the top down, large sections at a time, gently pulling the film downward and outward.

Note: Tearing the film aggressively can damage the paint.

3. Take care in removing the protective film near edges and corners to prevent paint damage in these areas.
4. The protective film should not be left on the painted surface for extended periods of time nor exposed to heat sources and direct sunlight.

Section 4.4—Resistors

By removing the small glass cover on the upper bevel on the rear of the



Woofer Module of your Chronosonic XVX, you may gain access to the resistor plate. These resistors serve several functions.

Note: Only Wilson Audio replacement resistors should be used in your Chronosonic XVX. Changing the value or brand of resistor will have a deleterious affect on the sonic performance of your loudspeakers and will void your Wilson Audio Warranty.

Midrange and Tweeter Resistors

There are two separate midrange level resistors. The 4" mid consists of a 1.5Ω resistor (four 1.5Ω resistors in series/parallel) resistor assembly, and the set of 7" mids, which consists of 0.10Ω (Four 0.10Ω resistors in series/parallel) resistor assembly. The tweeter level consists of a 2.1Ω (Four 2.1Ω resistors in series/parallel) resistor assembly. Resistors provide precise level matching for the midrange and tweeter drivers correspondingly. The resistors also act as a ultra-high-quality fuse which opens before a driver can be damaged by excess power.

Woofer Damping Resistor

There is a resistor for the Rear-firing Tweeter, which consists of a 4.8Ω resistor. There is a 14.5Ω barrel resistor barrel resistor for woofer level. This resistor is pre-installed in the base of the Woofer Module and should not be changed

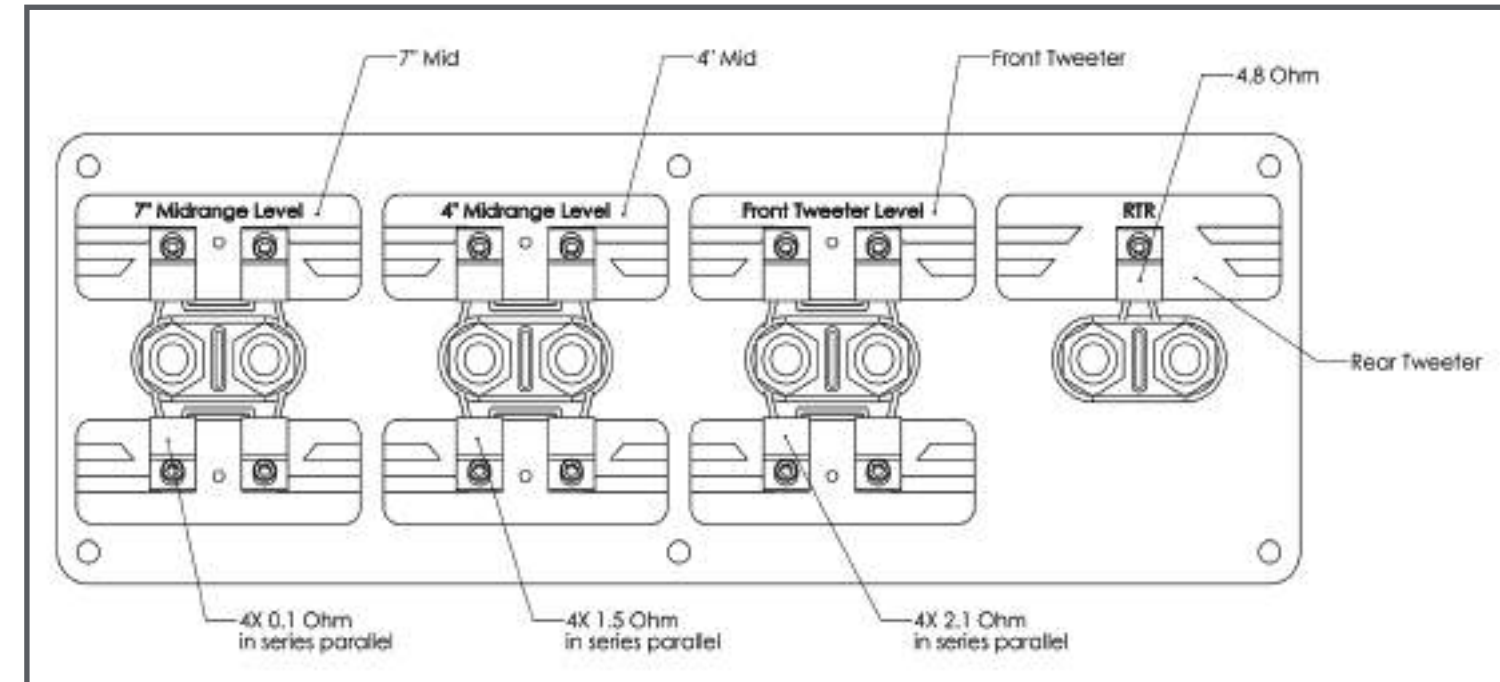

by the end user.

Resistor Fine Tuning

In rare instances for some installations, it is desirable to alter the level of the tweeter to overcome tonal balance problems. If there is a need to increase the level of the tweeter by 1dB, a 1.0Ω resistor should be used (4 X 1.0Ω in series/parallel). If a decrease in tweeter level is desired, a 3.2Ωs resistor will decrease the level by 1dB (4 X 3.2Ω in series/parallel).

Note: These specialized resistors can be ordered from you authorized Wilson dealer. Only

use Wilson replacement resistors in your Chronosonic XVX.

Section 4.5—Adjusting the Chronosonic XVX's XLF Port

Choosing a Port Configuration

Based on the measured bass response of the two different port configurations, our experience suggests the following as a starting point: For inherently lossy and lean rooms, which are thus in need of additional deep bass reinforcement, the rear-firing port configuration is recommended as a starting place. If the mid-to-upper bass is lean in your installation, the forward-firing port configuration is probably optimal.

If your installation requires the Chronosonic XVX to be installed close to the rear wall behind the speakers, start by installing the port in its front-firing configuration first so as to avoid potential bass overload in your room. However, if another loudspeaker has already proven to be too lean in this same location, start with the Chronosonic XVX's port in the rear firing configuration.

In systems where the Chronosonic XVX is replacing an Alexandria X-2, X-1 Grand SLAMM, Alexia or other rear-firing bass port system, it is generally recommended that the rear-firing port configuration be initially installed.

Because there are a vast number of acoustical environments into which the Chronosonic XVX is installed, it is impossible to give absolute instructions

for every given room. Each Chronosonic XVX should be evaluated in its environment, and a determination made from there.

Warning: The bass performance of the Chronosonic XVX will be severely compromised if the port is not installed in one of its two locations.

Reversing the Port Plug

The Chronosonic XVX ships with the port plug installed in the front of the woofer enclosure for a rear-firing port configuration. To reverse the plug, do the following.

1. Locate the Allen handle and the 1/8" Allen tip from the tool kit. Install the tip into the handle.
2. To remove the port plug, unbolt the six 10-32x1" button head Allen screws and washers and remove metal cover.
3. Remove the decorative port ring from the rear port.
4. Install the port plug into the rear port.
5. Install the port cover plate over the plug.
6. Install the decorative port ring into the now active front port.

Section 4.6—The Rear Tweeter Module Attenuator

The attenuator on the Rear-firing Tweeter is one of the technical innovations within the Chronosonic XVX. The XLF bass port accounts for the archi-

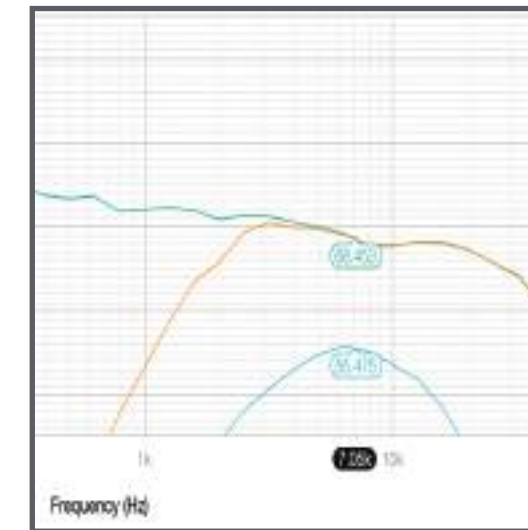

tectural differences in rooms in the bass region. Similarly, the addition of an ultra-high-quality attenuator for the Rear Tweeter improves the XVX's ability to interface within a variety of environments.

The rear tweeter is in play centered on a frequency of approximately 7kHz. In a typical room, it is -13dB relative to the Front Tweeter at a measurement distance of 8.5 feet if the attenuator is left at full level—turned entirely clockwise. At its lowest setting—with the attenuator in the further counter-clockwise position—the rear tweeter is effectively muted (-37dB).

Because ceiling heights differ, as does the relative distance of the Chronosonic XVX from the rear wall, the attenuator enables the installer to trim the output from the Rear Tweeter to fit various scenarios. For installations featuring low ceilings and/or those settings where the rear of the loudspeaker is near the rear wall, the optimal setting for the Rear Tweeter will likely be somewhat attenuated. In those installations featuring taller ceilings and open spaces, the output of the tweeter will likely be higher.

Listening for high-frequency ambient cues as well as a sense of spatial sparkle is an excellent method for evaluating the output setting that suits your room and your musical preferences. If the tweeter level is too high, top-to-bottom coherence will suffer. If the rear tweeter is too low, the presentation will be somewhat closed down and spatially compromised. See the graph to the left, which illustrates the effect of the attenuator.

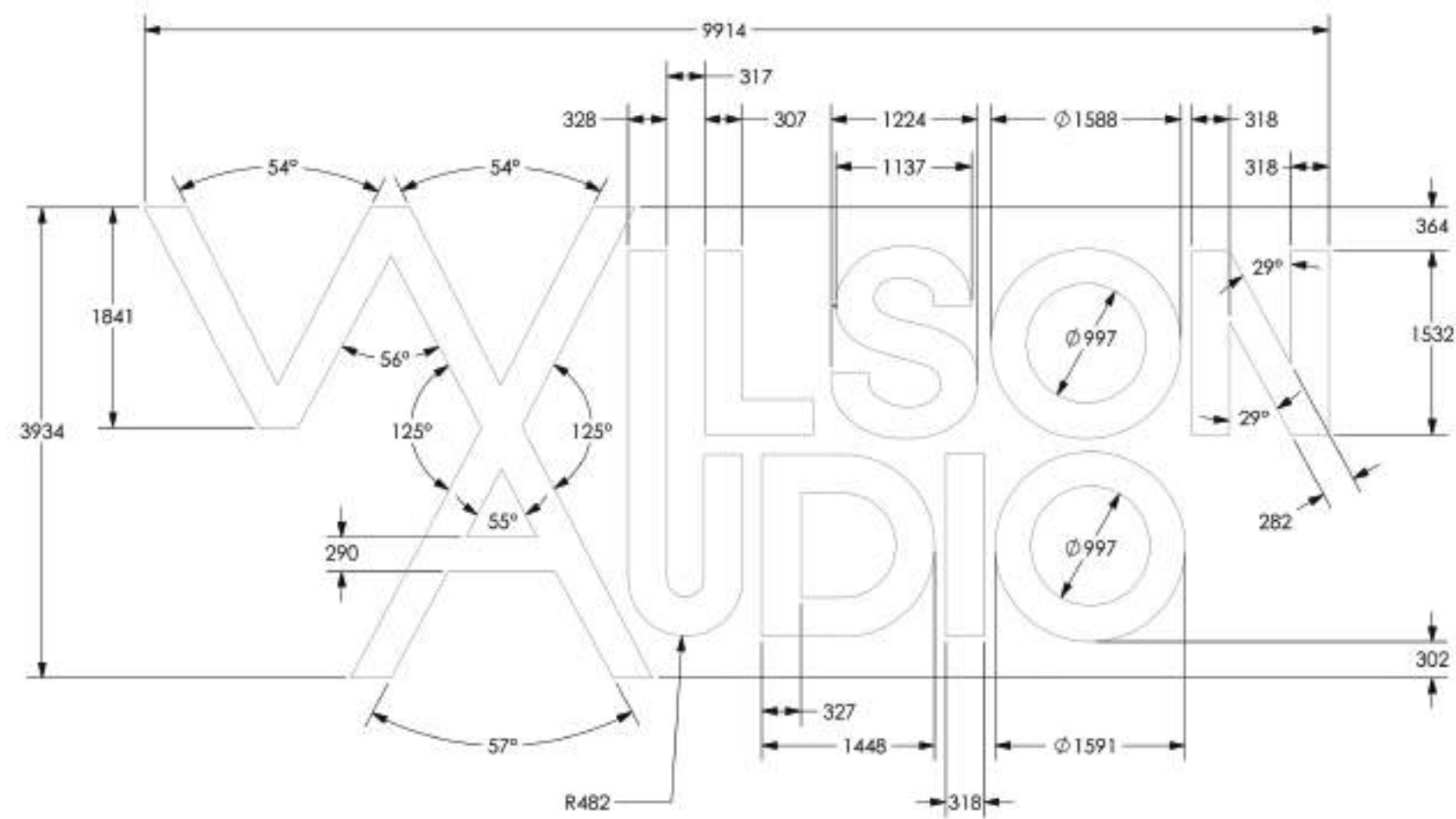

SECTION 5—SPECIFICATIONS

Section 5.1—Specifications

- Enclosure Type Woofer:** XLF port, adjustable rear or front firing
- Enclosure Type Lower Midrange 7":** Rear vented (Two Modules)
- Enclosure Type Upper Midrange 4":** Bottom vented
- Enclosure Type Tweeter:** Sealed
 - Woofers:** One—10.5 inch, (26.67 cm) Hard Paper Pulp
One—12.5 inch, (31.75 cm) Hard Paper Pulp
 - Midrange:** Two—7 inch (17.78 cm) Paper Pulp Composite
One—4 inch (10.16 cm) Paper Pulp Composite
 - Main Tweeter:** One—1 inch (2.54 cm) Doped Silk Fabric (Mk5 version)
 - Rear-firing Tweeter:** One—1 inch (2.54 cm) Doped Silk Fabric (Mk5 version)
- Sensitivity:** 92 dB @ 1W @ 1m @ 1kHz
- Nominal Impedance:** 4Ωs / minimum 1.6Ωs @ 326 Hz
- Minimum Amplifier Power:** 100 watts/channel
- Frequency Response:** 20 Hz – 30 kHz +/- 2 dB
- Overall Dimensions:** Height—73 5/8 inches (187 cm) w/o spikes
Width—16 1/2 inches (42 cm)
Depth—33 inches (84 cm)
- System Weight Per Channel:** 685 lbs (310.71 kg)
- Total System Shipping Weight (approx.):** 1,695 lbs (768.84 kg) (Approx.)

Section 5.2—Graphical Dimensions

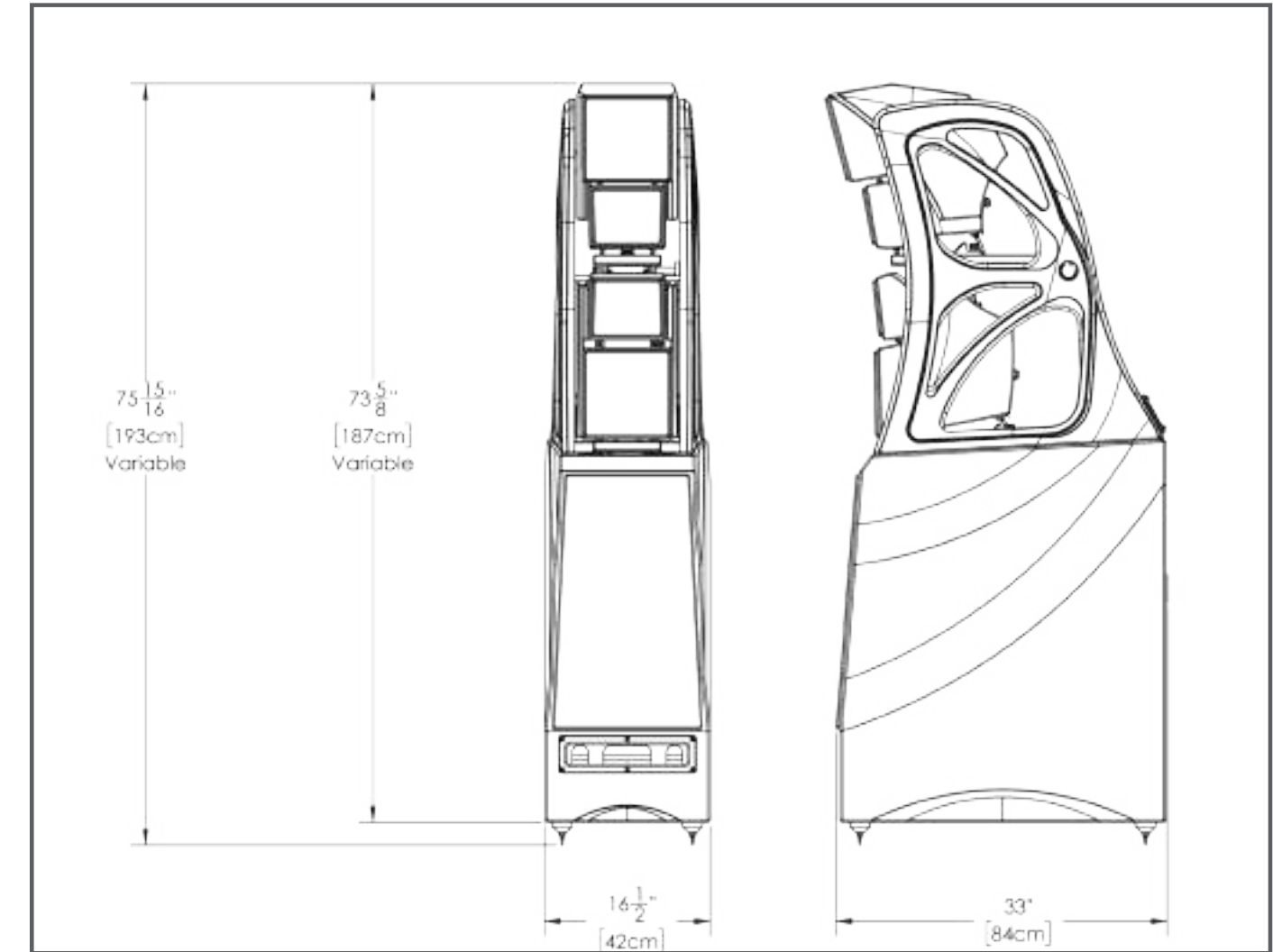

Section 5.3—Impedance Phase

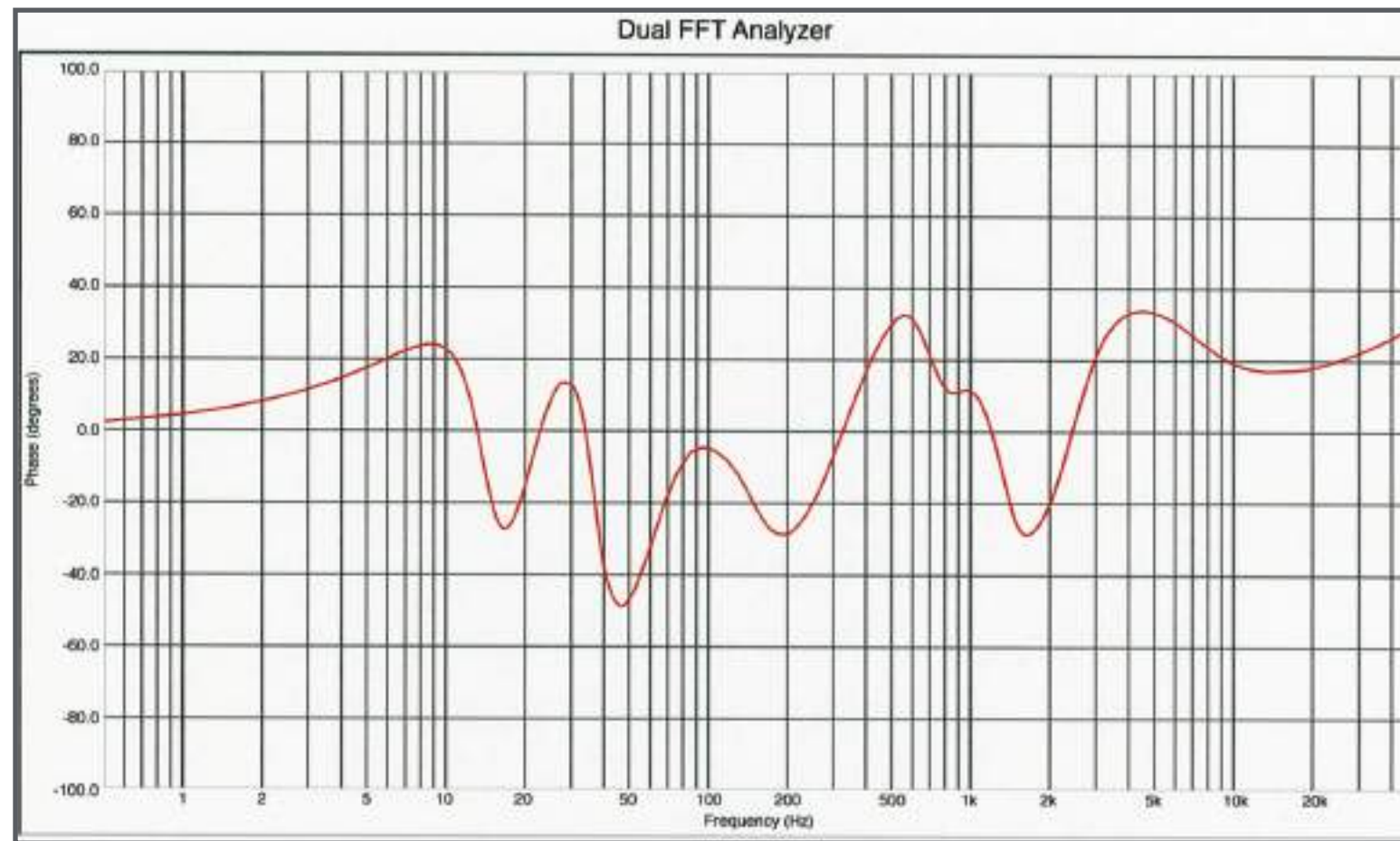

Section 5.4—Impedance Magnitude

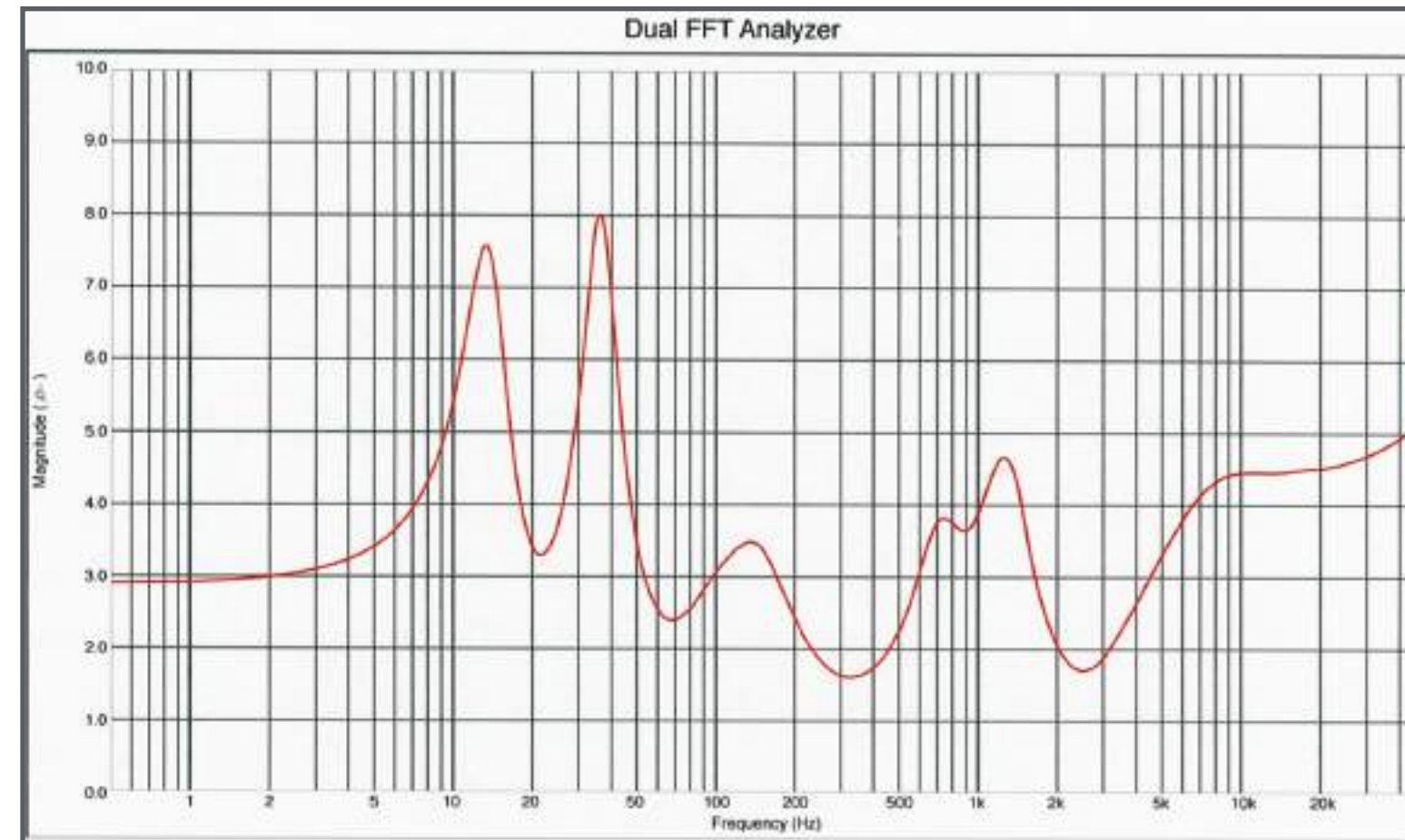



SECTION 6—TIME ALIGNMENT CHARTS

XVX Lower 7" Midrange Spike Length																
Ear Height		Listening Distance														
		8 ft	9 ft	10 ft	11 ft	12 ft	13 ft	14 ft	15 ft	16 ft	17 ft	18 ft	19 ft	20 ft	22 ft	24 ft
		2.44 m	2.74 m	3.05 m	3.35 m	3.66 m	3.96 m	4.27 m	4.57 m	4.88 m	5.18 m	5.49 m	5.79 m	6.1 m	6.71 m	7.32 m
48 in	122 cm	*	*	*	No Spike	No Spike	No Spike	No Spike	No Spike	No Spike	No Spike	No Spike	No Spike	No Spike	No Spike	No Spike
47 in	119.5 cm	No Spike	No Spike	No Spike	No Spike	No Spike	No Spike	No Spike	No Spike	No Spike	No Spike	No Spike	No Spike	No Spike	No Spike	No Spike
46 in	117 cm	No Spike	No Spike	No Spike	No Spike	No Spike	No Spike	No Spike	No Spike	No Spike	No Spike	No Spike	No Spike	No Spike	No Spike	No Spike
45 in	114.5 cm	No Spike	No Spike	No Spike	No Spike	No Spike	No Spike	No Spike	No Spike	No Spike	No Spike	No Spike	No Spike	No Spike	No Spike	No Spike
44 in	112 cm	No Spike	No Spike	No Spike	No Spike	No Spike	No Spike	No Spike	No Spike	No Spike	No Spike	No Spike	No Spike	No Spike	No Spike	No Spike
43 in	109 cm	2	No Spike	No Spike	No Spike	No Spike	No Spike	No Spike	No Spike	No Spike	No Spike	No Spike	No Spike	No Spike	No Spike	No Spike
42 in	106.5 cm	2	No Spike	No Spike	No Spike	No Spike	No Spike	No Spike	No Spike	No Spike	No Spike	No Spike	No Spike	No Spike	No Spike	No Spike
41 in	104 cm	2	2	No Spike	No Spike	No Spike	No Spike	No Spike	No Spike	No Spike	No Spike	No Spike	No Spike	No Spike	No Spike	No Spike
40 in	101.5 cm	2	2	2	2	No Spike	No Spike	No Spike	No Spike	No Spike	No Spike	No Spike	No Spike	No Spike	No Spike	No Spike
39 in	99 cm	2	2	2	2	2	2	No Spike	No Spike	No Spike	No Spike	No Spike	No Spike	No Spike	No Spike	No Spike
38 in	96.5 cm	2	2	2	2	2	2	No Spike	No Spike	No Spike	No Spike	No Spike	No Spike	No Spike	No Spike	No Spike
37 in	94 cm	2	2	2	2	2	2	2	No Spike	No Spike	No Spike	No Spike	No Spike	No Spike	No Spike	No Spike
36 in	91.5 cm	2	2	2	2	2	2	2	2	No Spike	No Spike	No Spike	No Spike	No Spike	No Spike	No Spike
34 in	86.5 cm	2	2	2	2	2	2	2	2	2	No Spike	No Spike	No Spike	No Spike	No Spike	No Spike

*	Contact dealer for set up information
	Remove upper light for listening position set up
	Use caution, upper array will be close to upper light
	Normal set up conditions

XVX Lower Array Alignment Block Step																
Ear Height		Listening Distance														
		8 ft	9 ft	10 ft	11 ft	12 ft	13 ft	14 ft	15 ft	16 ft	17 ft	18 ft	19 ft	20 ft	22 ft	24 ft
		2.44 m	2.74 m	3.05 m	3.35 m	3.66 m	3.96 m	4.27 m	4.57 m	4.88 m	5.18 m	5.49 m	5.79 m	6.1 m	6.71 m	7.32 m
48 in	122 cm	*	*	*	5	5	4	4	4	4	4	4	4	4	3	3
47 in	119.5 cm	7	6	6	5	5	5	5	4	4	4	4	4	4	4	3
46 in	117 cm	8	7	7	6	6	5	5	5	5	5	4	4	4	4	4
45 in	114.5 cm	9	8	7	7	6	6	6	5	5	5	5	5	4	4	4
44 in	112 cm	9	9	8	7	7	6	6	5	5	5	5	5	5	5	4
43 in	109 cm	2	9	9	8	7	7	7	6	6	6	6	5	5	5	4
42 in	106.5 cm	3	10	9	9	8	8	7	7	6	6	6	6	5	5	5
41 in	104 cm	3	2	10	9	9	8	8	7	7	7	6	6	6	5	5
40 in	101.5 cm	4	3	2	1	9	9	8	8	7	7	7	6	6	6	6
39 in	99 cm	5	4	3	2	1	9	9	8	8	7	7	7	7	6	6
38 in	96.5 cm	6	4	3	3	2	1	9	9	8	8	8	7	7	7	6
37 in	94 cm	6	5	4	3	2	2	1	9	9	8	8	7	7	7	6
36 in	91.5 cm	7	6	5	4	3	2	2	1	9	9	8	8	8	7	7
34 in	86.5 cm	9	7	6	5	4	3	2	2	1	9	9	9	8	8	7

*	Contact dealer for set up information
	Remove upper light for listening position set up
	Use caution, upper array will be close to upper light
	Normal set up conditions

XVX Lower Chronosonic Micrometer																
Ear Height		Listening Distance														
		8 ft	9 ft	10 ft	11 ft	12 ft	13 ft	14 ft	15 ft	16 ft	17 ft	18 ft	19 ft	20 ft	22 ft	24 ft
		2.44 m	2.74 m	3.05 m	3.35 m	3.66 m	3.96 m	4.27 m	4.57 m	4.88 m	5.18 m	5.49 m	5.79 m	6.1 m	6.71 m	7.32 m
48 in	122 cm	*	*	*	A37	A34.2	A32	A29.8	A28	A26.2	A25	A23.5	A22.5	A21.5	A19.5	A18
47 in	119.5 cm	A47.5	A42.5	A38.5	A35.5	A32.5	A30.2	A28.2	A26.5	A25	A23.5	A22.5	A21.5	A20.5	A18.5	A17
46 in	117 cm	A45	A40.2	A36.5	A33.5	A31	A29	A27	A25	A24	A22.5	A21.5	A20.5	A19.5	A18	A16.5
45 in	114.5 cm	A42.3	A38	A34.5	A31.8	A29.5	A27	A25.5	A24	A22.5	A21.5	A20	A19.5	A18.5	A17	A15.5
44 in	112 cm	A40	A36	A32.8	A30	A27.8	A25.8	A24	A22.5	A21	A20	A19	A18	A17.5	A16	A15
43 in	109 cm	A37.8	A33.8	A30.8	A28	A26	A24	A22.5	A21.2	A20	A19	A18	A15	A16.5	A15	A14
42 in	106.5 cm	A35.2	A31.8	A28.8	A26.5	A24.5	A22.5	A21	A20	A19	A18	A17	A16	A15.5	A14	A13
41 in	104 cm	A32.8	29.5	A27	A24.5	A22.5	A21	A20	A18.5	A17.5	A16.5	A16	A15	A14.5	A13	A12
40 in	101.5 cm	A30.2	A25.5	A24.8	A23	A21	A19.8	A18.5	A17.5	A16.2	A15.5	A14.5	A14	A13.5	A12.5	A11.5
39 in	99 cm	A28	A25	A23	A21	A19.5	A18	A17	A16	A15	A14.2	A13.5	A13	A12.5	A11.5	A10.5
38 in	96.5 cm	A25.5	A23	A21	A19.5	A18	A16.5	A15.5	A14.5	A14	A13	A12.5	A12	A11.5	A10.5	A10
37 in	94 cm	A23.2	A21	A19	A17.5	A16	A15	A14	A13.5	A12.5	A12	A11.5	A11	A10.5	A9.5	A9
36 in	91.5 cm	A20.8	A18.8	A17	A15.8	A14.5	A13.5	A12.8	A12	A11.5	A10.8	A10.2	A10	A9.5	A8.5	A8
34 in	86.5 cm	A16	A14.5	A13	A12	A11.5	A10.5	A10	A9.5	A9	A8.5	A8	A7.8	A7.5	A7	A6.5

*	Contact dealer for set up information
	Remove upper light for listening position set up
	Use caution, upper array will be close to upper light
	Normal set up conditions

XVX Lower 4" Mid Detent Position																
Ear Height		Listening Distance														
		8 ft	9 ft	10 ft	11 ft	12 ft	13 ft	14 ft	15 ft	16 ft	17 ft	18 ft	19 ft	20 ft	22 ft	24 ft
		2.44 m	2.74 m	3.05 m	3.35 m	3.66 m	3.96 m	4.27 m	4.57 m	4.88 m	5.18 m	5.49 m	5.79 m	6.1 m	6.71 m	7.32 m
48 in	122 cm	*	*	*	4	3	3	3	3	3	3	2	2	2	2	1
47 in	119.5 cm	5	4	4	4	3	3	3	3	3	2	2	2	2	2	1
46 in	117 cm	5	4	4	4	3	3	3	3	3	2	2	2	2	2	1
45 in	114.5 cm	5	4	4	4	3	3	3	3	3	2	2	2	2	2	1
44 in	112 cm	5	4	4	4	3	3	3	3	3	2	2	2	2	2	1
43 in	109 cm	5	5	4	4	3	3	3	3	3	2	2	2	2	2	1
42 in	106.5 cm	5	5	4	4	3	3	3	3	3	2	2	2	2	2	1
41 in	104 cm	5	5	4	4	3	3	3	3	3	2	2	2	2	2	1
40 in	101.5 cm	5	5	4	4	3	3	3	3	3	2	2	2	2	2	1
39 in	99 cm	5	5	4	4	3	3	3	3	3	2	2	2	2	2	1
38 in	96.5 cm	5	5	4	4	3	3	3	3	3	2	2	2	2	2	1
37 in	94 cm	5	5	4	4	3	3	3	3	3	2	2	2	2	2	1
36 in	91.5 cm	5	5	4	4	3	3	3	3	3	2	2	2	2	2	1
34 in	86.5 cm	5	5	4	4	3	3	3	3	3	2	2	2	2	2	1

*	Contact dealer for set up information
	Remove upper light for listening position set up
	Use caution, upper array will be close to upper light
	Normal set up conditions

Ear Height		Listening Distance														
		8 ft	9 ft	10 ft	11 ft	12 ft	13 ft	14 ft	15 ft	16 ft	17 ft	18 ft	19 ft	20 ft	22 ft	24 ft
		2.44 m	2.74 m	3.05 m	3.35 m	3.66 m	3.96 m	4.27 m	4.57 m	4.88 m	5.18 m	5.49 m	5.79 m	6.1 m	6.71 m	7.32 m
48 in	122 cm	*	*	*	2	2	2	2	2	2	2	2	2	No Spike	No Spike	No Spike
47 in	119.5 cm	3	3	3	2	2	2	2	2	2	2	2	2	2	No Spike	No Spike
46 in	117 cm	3	3	3	3	2	2	2	2	2	2	2	2	2	2	No Spike
45 in	114.5 cm	3	3	3	3	3	2	2	2	2	2	2	2	2	2	2
44 in	112 cm	3	3	3	3	3	3	2	2	2	2	2	2	2	2	2
43 in	109 cm	3	3	3	3	3	3	2	2	2	2	2	2	2	2	2
42 in	106.5 cm	4	3	3	3	3	3	2	2	2	2	2	2	2	2	2
41 in	104 cm	4	3	3	3	3	3	3	2	2	2	2	2	2	2	2
40 in	101.5 cm	4	3	3	3	3	3	3	3	3	2	2	2	2	2	2
39 in	99 cm	4	4	3	3	3	3	3	3	3	2	2	2	2	2	2
38 in	96.5 cm	4	4	3	3	3	3	3	3	3	2	2	2	2	2	2
37 in	94 cm	4	4	4	3	3	3	3	3	3	2	2	2	2	2	2
36 in	91.5 cm	4	4	4	4	3	3	3	3	3	2	2	2	2	2	2
34 in	86.5 cm	4	4	4	4	4	3	3	3	3	2	2	2	2	2	2

*	Contact dealer for set up information
	Remove upper light for listening position set up
	Use caution, upper array will be close to upper light
	Normal set up conditions

Ear Height		Listening Distance														
		8 ft	9 ft	10 ft	11 ft	12 ft	13 ft	14 ft	15 ft	16 ft	17 ft	18 ft	19 ft	20 ft	22 ft	24 ft
		2.44 m	2.74 m	3.05 m	3.35 m	3.66 m	3.96 m	4.27 m	4.57 m	4.88 m	5.18 m	5.49 m	5.79 m	6.1 m	6.71 m	7.32 m
48 in	122 cm	*	*	*	4	3	3	2	2	2	1	1	9	8	8	
47 in	119.5 cm	4	3	2	4	4	3	2	2	2	1	1	1	9	9	
46 in	117 cm	5	4	3	2	4	4	3	3	3	2	2	1	1	1	
45 in	114.5 cm	5	4	3	2	2	4	4	3	3	2	2	2	1	1	
44 in	112 cm	6	5	4	3	2	2	4	3	3	3	2	2	1	1	
43 in	109 cm	7	5	4	3	3	2	4	4	3	3	2	2	2	1	
42 in	106.5 cm	3	6	5	4	3	2	4	4	3	3	3	2	2	1	
41 in	104 cm	4	7	5	4	4	3	2	2	4	4	3	3	2	2	
40 in	101.5 cm	4	7	6	5	4	3	3	2	1	1	4	3	3	2	
39 in	99 cm	5	3	7	5	4	4	3	2	2	1	4	4	3	2	
38 in	96.5 cm	6	3	7	6	5	4	3	3	2	2	4	4	3	2	
37 in	94 cm	6	5	3	6	5	5	4	3	3	2	4	4	4	3	
36 in	91.5 cm	7	5	4	2	6	5	4	4	3	2	5	4	4	3	
34 in	86.5 cm	8	6	5	3	2	6	5	4	4	3	5	5	4	3	

*	Contact dealer for set up information
	Remove upper light for listening position set up
	Use caution, upper array will be close to upper light
	Normal set up conditions

Ear Height		Listening Distance														
		8 ft	9 ft	10 ft	11 ft	12 ft	13 ft	14 ft	15 ft	16 ft	17 ft	18 ft	19 ft	20 ft	22 ft	24 ft
		2.44 m	2.74 m	3.05 m	3.35 m	3.66 m	3.96 m	4.27 m	4.57 m	4.88 m	5.18 m	5.49 m	5.79 m	6.1 m	6.71 m	7.32 m
48 in	122 cm	*	*	*	A60	A58	A56	A54.2	A53	A52	A50.5	A49.5	A48.5	A48	A46.5	A45
47 in	119.5 cm	A64.8	A61.5	A58.5	A56.2	A54.2	A52.5	A51	A50	A49	A48	A47	A46.5	A45.5	A44.5	A43.5
46 in	117 cm	A59.5	A56.5	A54.2	A52.2	A50.5	A49.5	A48	A47	A46	A45.5	A44.5	A44	A43.5	A42.5	A41.5
45 in	114.5 cm	A54	A52	A50	A48.5	A47	A46	A45	A44	A43.5	A42.8	A42	A41.8	A41	A40.5	A40
44 in	112 cm	A48.9	A47	A45.8	A44.5	A43.5	A42.5	A42	A41	A40.5	A40	A40	A39.5	A39	A38.5	A38
43 in	109 cm	A43.5	A42.2	A41.5	A40.5	A40	A39	A38.5	A38.5	A38	A37.5	A37	A37	A36.8	A36.5	A36
42 in	106.5 cm	A38.2	A37.8	A35	A36.5	A36	A36	A35.5	A35.5	A35	A35	A35	A34.5	A34.5	A34.5	A34
41 in	104 cm	A33	A32.8	A32.8	A32.5	A32.5	A32.5	A32.5	A32.5	A32.5	A32.5	A32.5	A32.5	A32.5	A32.5	A32.5
40 in	101.5 cm	A27.5	A28	A28.2	A28.5	A29	A29	A29.5	A29.8	A30	A30	A30	A30	A30.5	A30.5	A30.5
39 in	99 cm	A22	A23.2	A24	A24.5	A25	A26	A26	A26.5	A27	A27	A27.5	A27.8	A28	A28.5	A28.5
38 in	96.5 cm	A16.9	A18.5	A19.8	A21	A21.8	A22.5	A23	A23.8	A24	A24.8	A25	A25.5	A25.8	A26.5	A27
37 in	94 cm	A11.5	A13.5	A15.5	A16.8	A18	A19	A20	A20.8	A21.5	A22	A22.5	A23	A23.5	A24.5	A25
36 in	91.5 cm	A6	A8.8	A11	A13	A14.5	A15.8	A17	A18	A18.5	A19.5	A20	A20.5	A21.5	A22.5	A25
34 in	86.5 cm	B21	B25	A2	A5	A7	A9	A10.5	A12	A13	A14	A15.2	A16	A17	A18	A19.5

*	Contact dealer for set up information
	Remove upper light for listening position set up
	Use caution, upper array will be close to upper light
	Normal set up conditions

Ear Height		Listening Distance														
		8 ft	9 ft	10 ft	11 ft	12 ft	13 ft	14 ft	15 ft	16 ft	17 ft	18 ft	19 ft	20 ft	22 ft	24 ft
		2.44 m	2.74 m	3.05 m	3.35 m	3.66 m	3.96 m	4.27 m	4.57 m	4.88 m	5.18 m	5.49 m	5.79 m	6.1 m	6.71 m	7.32 m
48 in	122 cm	*	*	*	6	6	6	7	7	7	7	7	7	8	8	8
47 in	119.5 cm	4	5	5	6	6	6	7	7	7	7	7	7	8	8	8
46 in	117 cm	4	5	5	6	6	6	7	7	7	7	7	7	8	8	8
45 in	114.5 cm	4	5	5	6	6	6	7	7	7	7	7	7	8	8	8
44 in	112 cm	4	5	5	6	6	6	7	7	7	7	7	7	8	8	8
43 in	109 cm	4	5	5	6	6	6	7	7	7	7	7	7	8	8	8
42 in	106.5 cm	4	5	5	6	6	6	7	7	7	7	7	7	8	8	8
41 in	104 cm	4	5	5	6	6	6	7	7	7	7	7	7	8	8	8
40 in	101.5 cm	4	5	5	6	6	6	7	7	7	7	7	7	8	8	8
39 in	99 cm	4	5	5	6	6	6	7	7	7	7	7	7	8	8	8
38 in	96.5 cm	4	5	5	6	6	6	7	7	7	7	7	7	8	8	8
37 in	94 cm	4	5	5	6	6	6	7	7	7	7	7	7	8	8	8
36 in	91.5 cm	4	5	5	6	6	6	7	7	7	7	7	7	8	8	8
34 in	86.5 cm	4	5	5	6	6	6	7	7	7	7	7	7	8	8	8

*	Contact dealer for set up information
	Remove upper light for listening position set up
	Use caution, upper array will be close to upper light
	Normal set up conditions



SECTION 7—WARRANTY

Wilson Audio Specialties

Section 7.1—Limited Warranty

Subject to the conditions set forth herein, Wilson Audio warrants its electronics to be free of manufacturing defects in material and workmanship for the Warranty Period. The Warranty Period is a period of 90 days from the date of purchase by the original purchaser, or if both of the following two requirements are met, the Warranty Period is a period of five (5) years from the date of purchase by the original purchaser:

Requirement No. 1. No later than 30 days after product delivery to the customer, the customer must have returned the Warranty Registration Form to Wilson Audio. Alternatively, the warranty may be filled out on-line.

Requirement No. 2. The product must have been professionally installed by the Wilson Audio dealer that sold the product to the customer.

FAILURE TO COMPLY WITH EITHER REQUIREMENT NO. 1 OR REQUIREMENT NO. 2 WILL RESULT IN THE WARRANTY PERIOD BEING LIMITED TO A PERIOD OF 90 DAYS ONLY.

Section 7.2—Conditions

This Limited Warranty is also subject to the following conditions and limitations. The Limited Warranty is void and inapplicable if the product has been used or handled other than in accordance with the instructions in the owner's manual, or has been abused or misused, damaged by accident or neglect or in

being transported, or if the product has been tampered with or service or repair of the product has been attempted or performed by anyone other than Wilson Audio, an authorized Wilson Audio Dealer Technician or a service or repair center authorized by Wilson Audio to service or repair the product. Contact Wilson Audio at (801) 377-2233 for information on location of Wilson Audio Dealers and authorized service and repair centers. Most repairs can be made in the field. In instances where return to Wilson Audio's factory is required, the dealer or customer must first obtain a return authorization. Purchaser must pay for shipping to Wilson Audio, and Wilson Audio will pay for shipping of its choice to return the product to purchaser. A RETURNED PRODUCT MUST BE ACCOMPANIED BY A WRITTEN DESCRIPTION OF THE DEFECT. Wilson Audio reserves the right to modify the design of any product without obligation to purchasers of previously manufactured products and to change the prices or specifications of any product without notice or obligation to any person.

Section 7.3—Remedy

In the event that the product fails to meet the above Limited Warranty and the conditions set forth herein have been met, the purchaser's sole remedy under this Limited Warranty shall be to: (1) contact an authorized Wilson Audio Dealer within the Warranty Period for service or repair of the product without charge for parts or labor, which service or repair, at the Dealer's option, shall

take place either at the location where the product is installed or at the Dealer's place of business; or (2) if purchaser has timely sought service or repair and the product cannot be serviced or repaired by the Dealer, then purchaser may obtain a return authorization from Wilson Audio and at purchaser's expense return the product to Wilson Audio where the defect will be rectified without charge for parts or labor.

Section 7.4—Warranty Limited to Original Purchaser

This Limited Warranty is for the sole benefit of the original purchaser of the covered product and shall not be transferred to a subsequent purchaser of the product, unless the product is purchased by the subsequent purchaser from an authorized Wilson Audio Dealer who has certified the product in accordance with Wilson Audio standards and requirements and the certification has been accepted by Wilson Audio, in which event the Limited Warranty for the product so purchased and certified shall expire at the end of the original Warranty Period applicable to the product.

Section 7.5—Demonstration Equipment

Equipment, while used by an authorized dealer for demonstration purposes, is warranted to be free of manufacturing defects in materials and workmanship for a period of five (5) years from the date of shipment to the dealer. Demo

equipment needing warranty service may be repaired on-site or, if necessary, correctly packed and returned to Wilson Audio by the dealer at dealer's sole expense. Wilson Audio will pay return freight of its choice. A returned product must be accompanied by a written description of the defect. Dealer owned demonstration equipment sold at retail within two (2) years of date of shipment to the dealer is warranted to the first retail customer to be free of manufacturing defects in materials and workmanship for the same time periods as if the product had originally been bought for immediate resale to the retail customer. Wilson Audio products are warranted for a period of 90 days, unless extended to 5 years, as provided above, by return and filing of completed Warranty Registration at Wilson Audio within 30 days after product delivery to customer and the product was professionally installed by the Wilson Audio Dealer that sold the product to the customer.

Section 7.6—Miscellaneous

ALL EXPRESS AND IMPLIED WARRANTIES NOT PROVIDED FOR HEREIN ARE HEREBY EXPRESSLY DISCLAIMED. ANY LEGALLY IMPOSED IMPLIED WARRANTIES RELATING TO THE PRODUCT SHALL BE LIMITED TO THE DURATION OF THIS LIMITED WARRANTY. THIS LIMITED WARRANTY DOES NOT EXTEND TO ANY INCIDENTAL OR CONSEQUENTIAL COSTS OR DAMAGES TO THE PURCHASER.

Some states do not allow limitations on how long an implied warranty lasts

or an exclusion or limitation of incidental or consequential damages, so the above limitations or exclusions may not apply to you. This Limited Warranty gives you specific legal rights, and you may also have other rights, which vary from state to state.



- Replacement Resistors
- Books and Literature
- Signature Loudspeaker Covers
- Installation Tools and Accessories
- Replacement Grills and Diffraction Blankets
- WilsonGloss Care Products and Kits
- Wilson Signature Apparel
- . . . And More

Linked to the QR code above.

Visit our service YouTube channel to view how-to videos linked to the QR Code to the right.

