

USER GUIDE

**A C E W I R E L E S S S E R I E S
B Y P I E G A**

E X P E C T M O R E

OPERATING INSTRUCTIONS

Ace Wireless by PIEGA

CONTENTS

1 CONTENTS	3
2 IMPORTANT SAFETY INSTRUCTIONS	4
3 THE ACE SPEAKERS AT A GLANCE	5
3.1 Integrated Streaming Clients & WiSA Module	6
3.1.1 Spotify connect	6
3.1.2 Google Chromecast built-in	6
3.1.3 ROON Ready	6
4 OPERATING ELEMENTS OF THE SPEAKERS	7
4.1 THE ACE Tx	7
4.2 THE ACE Rx	8
5 CHOOSE YOUR FAVOURITE SETUP	9
5.1 MINI-SETUP	10
5.1.1 How to install your Mini-Setup	10
5.2 WIRED TV INTEGRATION	11
5.2.1 How to set up wired TV integration	12
5.3 WiSA WIRELESS TV INTEGRATION AND HOME CINEMA	13
5.3.1 How to create your wireless home cinema	13
5.4 INSTALLATION FOR HI-FI-ENTHUSIASTS	14
5.4.1 How to set up a high end installation	14
6 CONNECT TO LOCAL NETWORK (WIFI)	15
6.1 GOOGLE HOME APP	15
6.2 DIRECT WIRELESS ACCESS	16
6.3 DIRECT ACCESS VIA ETHERNET CABLE	16
7 ANTENNA AND NETWORK CONNECTION	17
7.1 INTERNAL ANTENNA	17
7.2 ETHERNET CONNECTION	17
7.3 EXTERNAL WIFI ANTENNA	17
8 WIRELESS SURROUND SOUND WITH WiSA ...	18
8.1 PAIR YOUR ACE WIRELESS	18
8.2 WIRELESS CONNECTION TO WiSA DEVICES ..	18
9 CONFIGURATION	19
9.1 STEREO CONFIGURATION	19
9.2 «SOUND» SWITCH	19
9.3 WIRELESS ON/OFF	20
9.3.1 WiFi functions Ace Tx	20
9.3.2 WiFi functions Ace Rx	20
9.4 VOLUME CONTROL BY REMOTE	21
9.5 WEB INTERFACE	22
10 TV CONNECTIVITY OPTIONS	23
10.1 WiSA WIRELESS	23
10.2 HDMI (e)ARC	23
10.3 FURTHER CONNECTIVITY	24
11 BLUETOOTH CONNECTION	25
11.1 BLUETOOTH PAIRING MODE	25
12 AUTOMATIC INPUT SOURCE SELECTION	25
13 PIEGA WIRELESS SYSTEM	26
14 RESET	27
15 FIRMWARE-UPDATE	28
15.1 UPDATE YOUR Rx	28
15.2 UPDATE YOUR Tx	28
15.2.1 Webinterface update	28
15.2.2 Memorystick update	28
16 SETUP INTERFACE FOR AUDIOPHILES	29
17 LED INDICATORS AT A GLANCE	31
18 TECHNICAL DATA	32
19 DECLARATION OF CONFORMITY	33

2 IMPORTANT SAFETY INSTRUCTIONS

1. Retain this user guide for future reference.
2. Read all safety instructions carefully.
3. Heed all warnings.
4. Follow all instructions and recommendations.
5. Do not use this apparatus near water.
6. Clean only with dry and soft cloth.
7. Do not install near any heat sources such as radiators, heat registers, stoves or other devices that produce heat.
8. Protect the power cord from being stepped on or pinched, particularly at plugs, convenience receptacles and at the point they exit from the apparatus.
9. Only use accessories or attachments approved by the manufacturer.
10. Do not defeat the safety purpose of the polarised plug. If the provided plug does not fit into your outlet, consult an electrician for replacement of the obsolete outlet.
11. Unplug this apparatus during thunderstorms or when unused for long periods of time.
12. Refer all servicing to qualified personnel. Servicing is required if the apparatus has been damaged in any way, e.g. the power supply cord or plug is damaged, liquid has been spilled or objects have fallen into the apparatus. Equally if it has been exposed to rain or moisture, does not operate normally, or has been dropped.
13. The power plug should be easily accessible to disconnect the equipment at any time.
14. Warning: To reduce the risk of fire and electric shock, do not expose this apparatus to rain or moisture.
15. Do not expose the apparatus to dripping or splashing and do not place objects filled with liquids, such as vases and glasses on the apparatus.
16. Maintain 150 mm safety clearance all around the apparatus to ensure adequate ventilation.
17. Do not block any ventilation openings. Install in accordance with the manufacturer's instructions.
18. Do not place objects with naked flames, such as lit candles on the apparatus.
19. This apparatus is approved for indoor use only.

3 THE ACE SPEAKERS AT A GLANCE

The Ace Wireless series includes the following speakers:



Ace 50 Wireless
(Models: Tx / Rx)



Ace 30 Wireless
(Models: Tx / Rx)



Ace Center Wireless
(Models: Rx)

Scope of delivery

The scope of delivery includes:

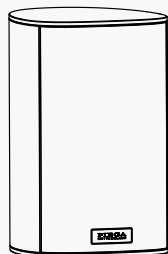

speaker

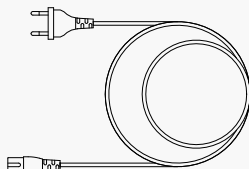

power cable

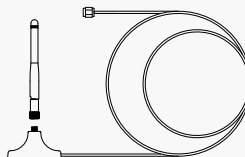

external antenna with stand
and cable (Tx)

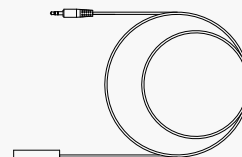

infrared interface (Tx)

3.1 INTEGRATED STREAMING CLIENTS & WISA MODULE

The Ace Wireless speakers (Tx model) come with the following integrated streaming clients: Google Chromecast, Spotify Connect, Roon Ready. In addition, they have been equipped with a WiSA module, which allows you to connect them wirelessly to any WiSA supporting TV.

3.1.1 SPOTIFY CONNECT

Spotify connect allows you to play your music directly from the Spotify app on your Ace Wireless speakers.



The Spotify software is subject to third party licenses found here:

<https://www.spotify.com/connect/third-party-licenses>.

Use your phone, tablet or computer as a remote control for Spotify. Go to [spotify.com/connect](https://www.spotify.com/connect) to learn how.

3.1.2 GOOGLE CHROMECAST BUILT-IN

Google Chromecast supports various music platforms and radio stations. With Google Chromecast, you can easily play music from your mobile device on your Ace speakers.



Chromecast built-in is a trademark of Google LLC.

3.1.3 ROON READY

Roon Ready network devices have Roon's streaming technology built in, and are certified by Roon Labs to provide the highest level of quality and performance in network streaming.

<https://roonlabs.com/>



4 OPERATING ELEMENTS OF THE ACE SPEAKERS

4.1 THE ACE TX

Tx stands for «Transmitting Unit», meaning the Tx speaker transmits data to other (Rx) speakers.
For this purpose, the Tx has been equipped with a number of wired inputs and streaming protocols.

THE TX CONNECTION PANEL AND ITS FUNCTIONS:

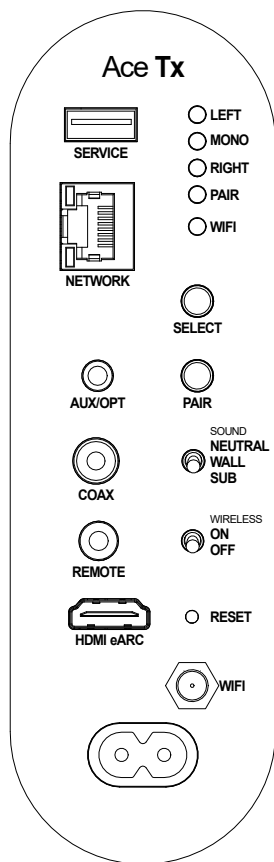

SERVICE	USB port for firmware updates.
NETWORK	Ethernet port for stable and fast connections to a local network.
AUX/OPT	Analog stereo input 3.5mm jack OR digital optical input S/PDIF.
COAX	Digital coaxial input S/PDIF.
REMOTE	Connects the enclosed infrared receiver to tune your remote.
HDMI eARC	HDMI input to connect a TV.
LEFT/MONO/RIGHT Indicators	Indicates the channel selected: left / mono / right.
PAIR Indicator	Indicates the connection status to the Rx speaker.
WIFI Indicator	Indicates the connection status to the local WiFi.
SELECT	Press this button to select the desired channel: left / mono / right.
PAIR	Press this button to pair with an Rx speaker.
SOUND	Flip this switch to choose a fitting sound setting (Presets).
WIRELESS	Flip this switch to activate or deactivate WiFi functions.
RESET	Use this to reset the apparatus to factory settings.
WIFI	Connects the enclosed external antenna for improved internet connectivity.

4.2 THE ACE RX

Rx stands for «Receiving Unit», meaning an Rx speaker can receive wireless signals from any WiSA transmitter (Tx). Besides being combined with a Tx, the Ace Rx can thus also be used to create a wireless (WiSA) home cinema setup.

THE RX CONNECTION PANEL AND ITS FUNCTIONS:

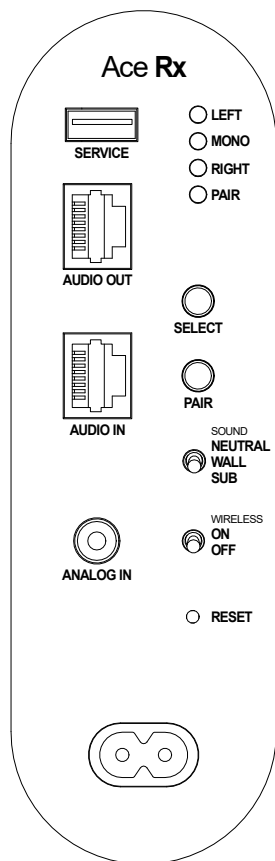

SERVICE	USB port for firmware updates.
AUDIO OUT	Analog stereo balance output. Produces the «AUDIO IN» signal. Suitable for installations with multiple speakers.
AUDIO IN	Analog stereo balance input. Suitable for installations with long signal paths.
ANALOG IN	Analog mono input.
LEFT/MONO/RIGHT Indicators	Indicates the channel selected: left / mono / right.
PAIR Indicator	Indicates the connection status to the Tx speaker or WiSA transmitter.
SELECT	Press this button to select the desired channel: left / mono / right.
PAIR	Press this button to pair with a Tx speaker or WiSA transmitter.
SOUND	Flip this switch to choose a fitting sound setting (Presets).
WIRELESS	Flip this switch to activate or deactivate WiFi functions.
RESET	Use this to reset the apparatus to factory settings.

5 CHOOSE YOUR FAVOURITE SETUP

The Ace wireless speakers can be connected and positioned to suit your personal sound preferences. In this section you will find an overview of different setup options including links to detailed information if you wish to take a closer look at one specific setup.

MINI-SETUP

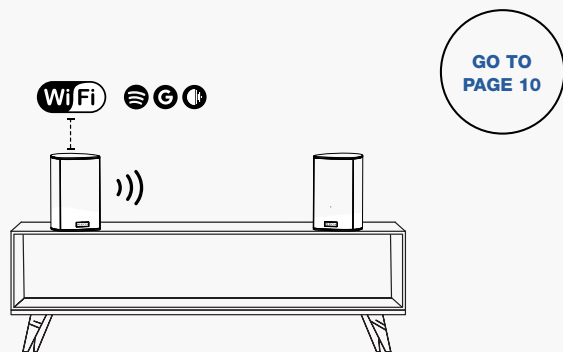

WIRED TV INTEGRATION

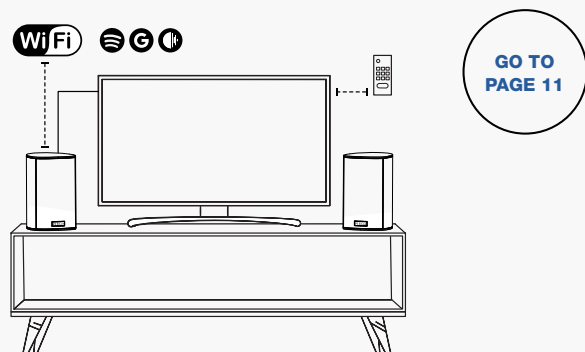

WISA WIRELESS TV INTEGRATION AND HOME CINEMA

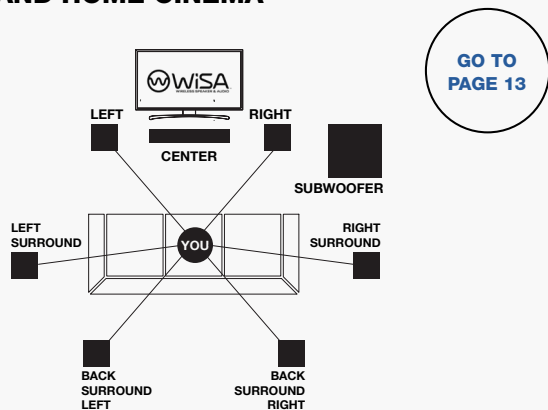

INSTALLATION FOR HIFI-ENTHUSIASTS

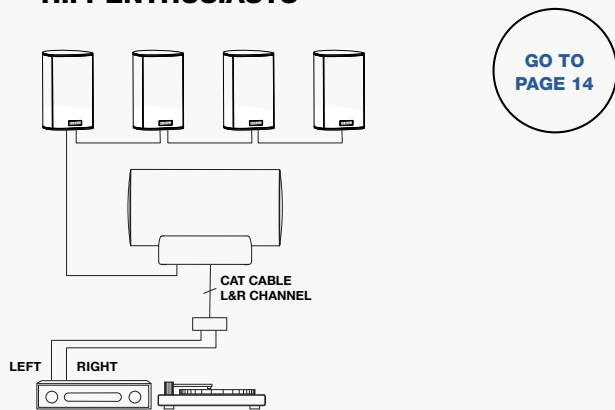

5.1 MINI-SETUP

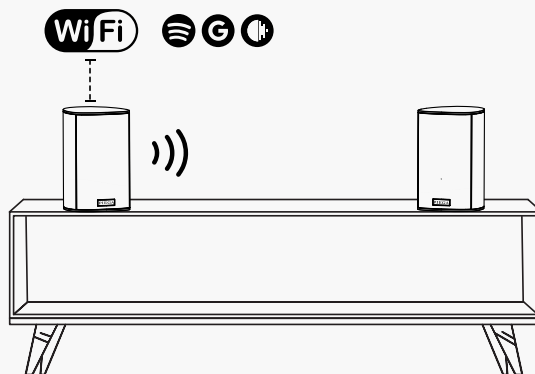

This ultra-lean all-in-one mini setup requires just two devices:

- one Tx speaker
- one Rx speaker

These two PIEGA Ace speakers are installed in no time and ready to play your favourite tunes conveniently controlled from any smart device.

5.1.1 HOW TO INSTALL YOUR MINI-SETUP

1. Position your speakers in the desired location.
2. Power your speakers.
3. Check the settings on each speaker. If you wish to connect to your local WiFi, both «WIRELESS» switches need to be «ON». Learn more about the WiFi functions: [WIRELESS ON/OFF](#)
4. Ensure power is connected for at least 1 minute, then start establishing the connection to the local WiFi:
See [CONNECT TO LOCAL NETWORK \(WIFI\)](#)
5. The two speakers can now be connected: See [PAIR YOUR ACE WIRELESS](#)
6. Once the connection has been established press «SELECT» and set to «LEFT», «MONO» or «RIGHT» according to the speaker positioning: See [STEREO CONFIGURATION](#)
7. Use the «SOUND» switch to adjust the sound settings. This selection mainly affects the bass reproduction.
Learn more: [«SOUND» SWITCH](#)

5.2 WIRED TV INTEGRATION

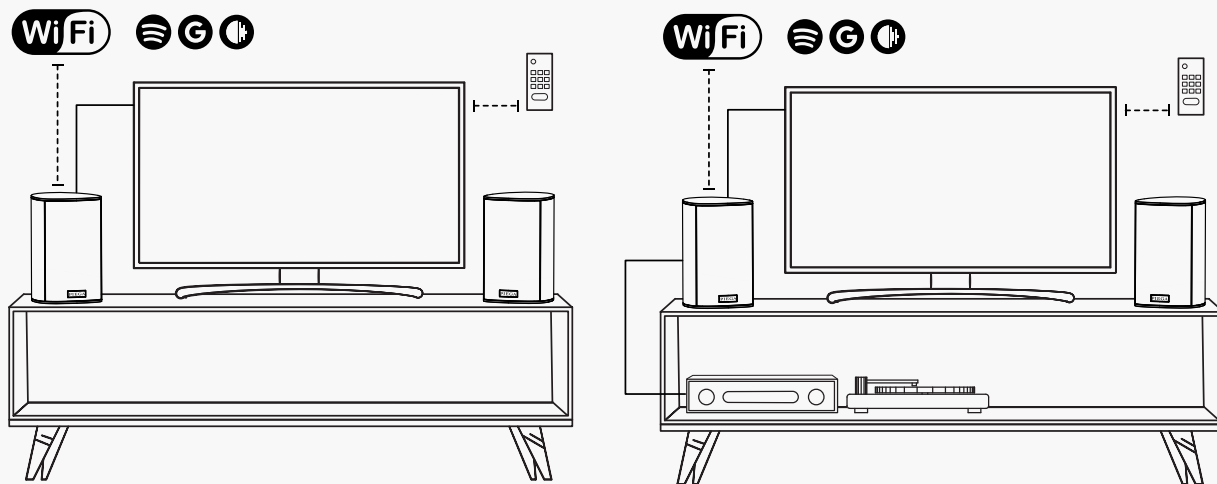

If you opt for wired TV integration you will need the following devices:

- **Tx and Rx speakers**
- **a TV**
- **optional: external devices such as CD and record players etc.**

In this setup the sound of your TV or other external devices is played through your Ace speakers.

5.2.1 HOW TO SET UP WIRED TV INTEGRATION

a) Basic setup

1. Position your speakers in the desired location.
2. Power your speakers.
3. Check the settings on each speaker. If you wish to establish a connection to the local WiFi, both «WIRELESS» switches need to be «ON». Learn more about the WiFi functions: [WIRELESS ON/OFF](#)
4. Ensure power is connected for at least 1 minute, then start establishing the connection to the local WiFi:
see [CONNECT TO LOCAL NETWORK \(WIFI\)](#)
5. Once the speakers appear on the local WiFi you can connect them with each other: see [PAIR YOUR ACE WIRELESS](#)
6. Then press «SELECT» and set to «LEFT», «MONO» or «RIGHT» according to the speaker positioning:
see [STEREO CONFIGURATION](#)
7. Use the «SOUND» switch to adjust the sound settings. This selection mainly affects the bass reproduction.
See: «SOUND» [SWITCH](#)

b) TV connection using HDMI eARC

1. Use an HDMI cable to connect the HDMI ARC output on your TV with the «HDMI eARC» input on your Tx.
Learn more: [HDMI \(e\)ARC](#)

c) TV connection using an optical connector

1. Nearly every TV comes with an optical output marked with «optical output».
2. Use any commercially available optical cable and connect this output with the «AUX/OPT» input on your Tx. An adapter for the «AUX/OPT» input has been included in the scope of delivery. Learn more about all connection options: [FURTHER CONNECTIVITY](#)

Now simply use your TV remote to conveniently control the volume of your Ace speakers.
Learn more: [VOLUME CONTROL BY REMOTE](#)

d) Connect external devices

The «AUX/OPT» or «COAX» input jack allows you to easily connect additional external sources such as CD or record players and conveniently adjust the volume with your TV remote.

5.3 WISA WIRELESS TV INTEGRATION AND HOME CINEMA

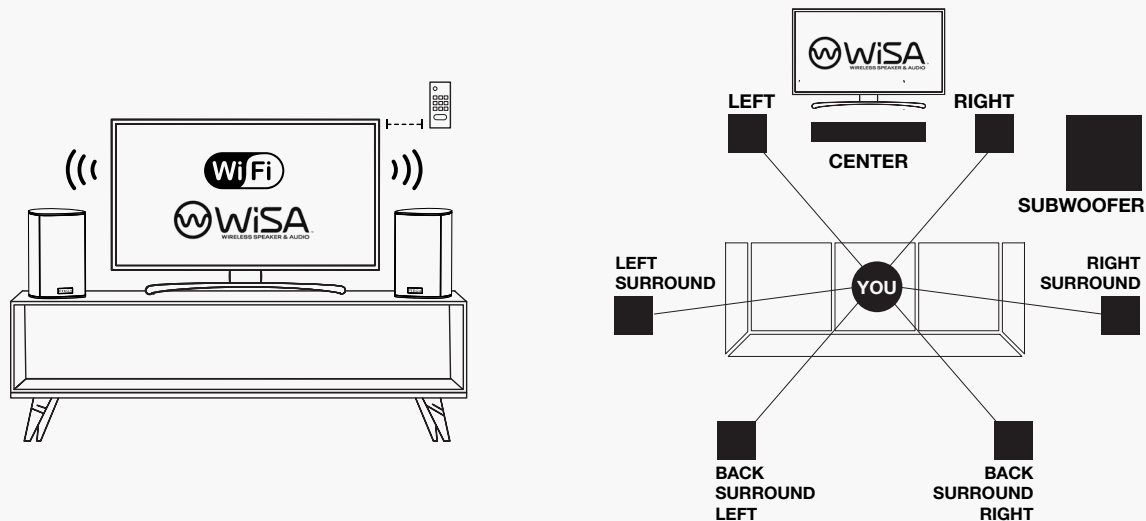

To create your personal home cinema setup with WiSA wireless TV integration you will need the following devices:

- **Rx speakers ONLY**
- **TV with integrated WiSA interface OR external WiSA transmitter, that can be connected with your TV**

WiSA allows you to establish a wireless connection between your TV and your Ace speakers. Now choose any setup from stereo to 7.1 surround sound. If your TV doesn't support WiSA, you can choose to connect any external WiSA transmitter.

5.3.1 HOW TO CREATE YOUR WIRELESS HOME CINEMA

1. Position your speakers in the desired location.
2. Power your speakers.
3. Make sure the «WIRELESS» switch is «ON» on all Rx speakers. Learn more about the WiFi functions: see [WIRELESS ON/OFF](#)
4. Now follow the operating instructions of your TV or WiSA transmitter.
5. Press «PAIR» on your Rx if your WiSA device doesn't recognise the speakers instantly.
Learn more here: [PAIR YOUR ACE WIRELESS](#)
6. Once the connection to the TV or WiSA transmitter has been established use the «SOUND» switch to adjust the sound settings. This selection mainly affects the bass reproduction. Learn more: [«SOUND» SWITCH](#)

5.4 INSTALLATION FOR HI-FI-ENTHUSIASTS

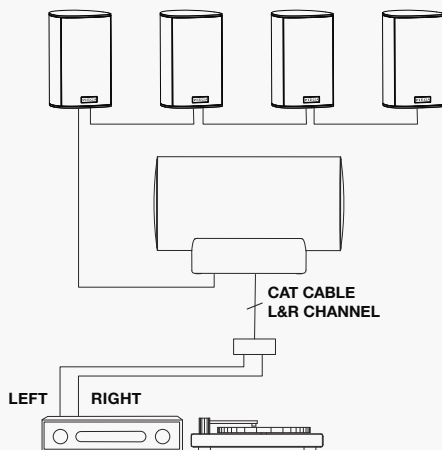

This expert setup reliably connects one or several speakers even via long signal lines. You will need the following devices:

- **Rx speakers ONLY**
- **playback devices such as network players or preamplifiers with balanced output**

The Ace Rx is equipped with a balanced analog input (stereo). Simply use a standard CAT network cable to connect the balanced stereo signal to your speaker.

5.4.1 HOW TO SET UP A HIGH END INSTALLATION

1. Position your speakers in the desired location.
2. Use a shielded CAT cable with RJ45 connector to connect the stereo analog audio signal with your speakers. Learn more about the pin assignment here: [FURTHER CONNECTIVITY](#)
3. Now power your speakers.
4. Make sure the «WIRELESS» switch is «OFF». Learn more about the different wireless functions: [WIRELESS ON/OFF](#)
5. Use the «SOUND» switch to adjust the sound settings. This selection mainly affects the bass reproduction. Learn more: [«SOUND» SWITCH](#)

6 CONNECT TO LOCAL NETWORK (WIFI)

Bear in mind, that out of the Ace Series only the Tx speaker needs a connection to the local network, the Rx doesn't need a network connection. The following sections thus **ONLY** apply to the Tx model.

6.1 GOOGLE HOME APP

Google Home offers a simple way of integrating your speakers into your local network and operating them easily:

1. Download the Google Home app on your smart device.
2. Power your speakers.
IMPORTANT: Ensure power is connected for at least 1 minute for Google Home to detect your speakers.
3. Open the Google Home app on your smart device.
4. A message should pop-up allowing you to select your PIEGA speaker. Alternatively, you can add a new device by pressing «+» in the upper area of the screen.
5. Follow the instructions on the app to complete the installation.

Note: If the setup with Google Home fails, we recommend using the «Reset» function on the rear panel of your Ace speaker (see [RESET](#)). Restarting your smart device might also help.

An unstable WiFi connection can also affect this process. Find out how to improve the connection stability: [ANTENNA AND NETWORK CONNECTION](#)

6.2 DIRECT WIRELESS ACCESS

By factory default or after performing a reset (see [RESET](#)), the speakers can be connected directly to your computer.

1. Power your speaker and wait for at least 1 minute until the WiFi indicator starts a slow green flash.
2. Open the WiFi settings on your laptop, computer or smart device and select your Ace speaker from the list of available networks. If the Ace speaker is not yet listed, press «SELECT» for 10 seconds.
3. Click on «Properties» to copy the IPv4 DNS address.
4. Paste the IPv4 DNS address in your browser window. You can now access your Ace speaker via web interface and start configuring your network preferences.

6.3 DIRECT ACCESS VIA ETHERNET CABLE

Alternatively, you can also access the same web interface via Ethernet.

1. Power your speaker and wait for at least 1 minute until the WiFi indicator starts a slow green flash.
2. Use a network cable to connect your speaker to your wireless router.
3. Your Ace speaker is now listed under «Network» on your computer.
4. Double click on the Ace symbol to open the web interface and choose your network settings.

7 ANTENNA AND NETWORK CONNECTION

7.1 INTERNAL ANTENNA

The Ace Tx speakers come with a built-in WLAN antenna, so they typically don't need further external antennas or an additional network connection. However, if you're repeatedly experiencing connectivity issues you may want to connect an external antenna or opt for an Ethernet connection.

7.2 ETHERNET CONNECTION

An Ethernet connection provides the best and most stable network connection. Simply use a network cable to connect your internet router to your Ace speaker.

To avoid possible interferences, we recommend an unshielded twisted pair cable.

7.3 EXTERNAL WIFI ANTENNA

If the built-in WiFi antenna doesn't provide the desired stability you can improve the connectivity by attaching the enclosed external antenna.

Note: This antenna only stabilises the internet connection, not the connection between the Tx and Rx speakers.

Tip: You can use your smartphone to check the WiFi quality at the chosen position. If it is poor, we recommend placing the speaker near a router while setting it up.

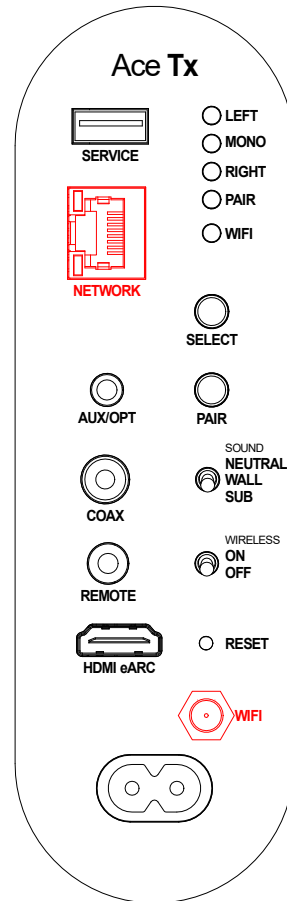

8 WIRELESS SURROUND SOUND WITH WiSA

WiSA certified devices enable wireless, hi-res multichannel audio signal transmission for a fantastic home cinema soundscape.

8.1 PAIR YOUR ACE WIRELESS

Establishing a wireless connection between your PIEGA speakers is super easy. Simply press «PAIR» on both speakers until the «PAIR» indicator starts flashing. An acoustic signal on the Rx indicates the start of the pairing process, the flashing indicator changes to a steady green upon successful pairing.

8.2 WIRELESS CONNECTION TO WISA DEVICES

For your WiSA device (TV, network player, etc.) to recognise your Ace Rx you need to press «PAIR» on the rear panel. The «PAIR» indicator starts flashing and an acoustic signal confirms the start of the pairing process.

Now follow the operating instructions of your WiSA device.

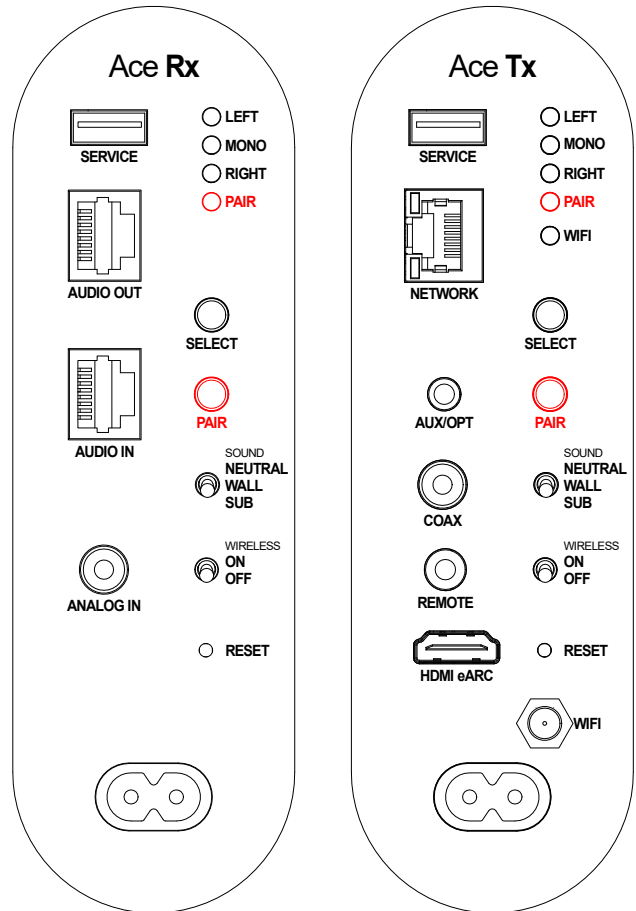

9 CONFIGURATION

9.1 STEREO CONFIGURATION

A music signal consists of a right and a left channel. Use the «SELECT» button to configure your speakers accordingly:

- **LEFT:** for the speaker positioned on the left
- **RIGHT:** for the speaker positioned on the right
- **MONO:** for a single speaker

9.2 «SOUND» SWITCH

The speakers position in a room impacts the music playback. Choose the correct setting for the best possible sound experience:

NEUTRAL: Flip the switch to «NEUTRAL» for speakers placed at least 50 cm from the wall.

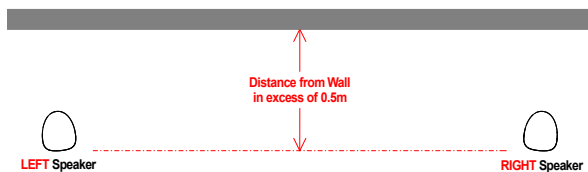

WALL: Flip the switch to «WALL» for speakers positioned less than 50 cm from the wall. In this setting bass tones below 100 Hz are reduced.

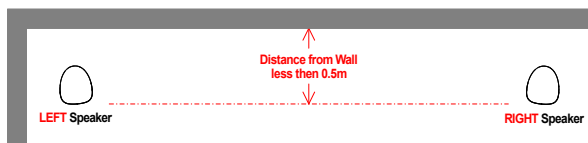

If you are using your Ace speakers in combination with a subwoofer, choose the following setting:

SUB: In this position a high pass filter cuts the bass. You can also use «SUB» if you generally prefer less bass.

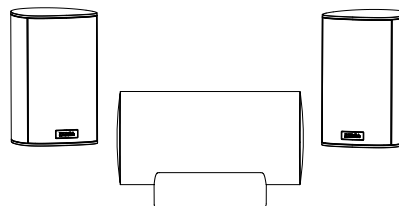

9.3 WIRELESS ON/OFF

This switch can be used to control the wireless modules as well as a number of other functions:

9.3.1 WIFI FUNCTIONS ACE TX

Function	Wireless OFF	Wireless ON
Streaming Clients • Google Chromecast • Spotify Connect • Roon Ready • Bluetooth	OFF No internet connection	ON
WISA Wireless connection to Rx speaker	ON OFF in standby mode, starting up will take longer	ON
HDMI	ON OFF in standby mode Starting up not possible via HDMI	ON
Infrared remote	ON	ON
Analog and digital S/ PDIF inputs	ON	ON

9.3.2 WIFI FUNCTIONS ACE RX

Function	Wireless OFF	Wireless ON
WISA connection OFF ON	OFF	ON
Analog input RCA & RJ45	ON	ON

9.4 VOLUME CONTROL BY REMOTE

Any infrared remote can be used to simply and conveniently control the following functions on your Ace speakers:

- **volume adjustment**
- **mute**

To set this up you will need the external infrared receiver included in the scope of delivery.

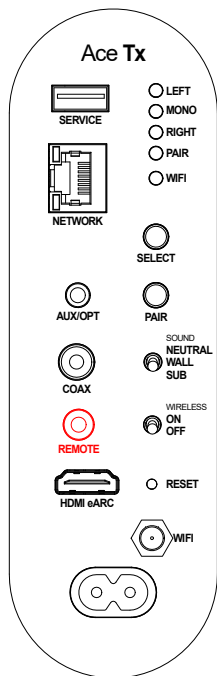

SIMPLY FOLLOW THESE STEPS:

1. Connect the external IR receiver to the «REMOTE» jack.
2. Simultaneously press «PAIR» and «SELECT» until the indicators «LEFT», «MONO» and «RIGHT» go off (approx. 5 seconds).
3. Release both «PAIR» and «SELECT».
4. All indicators «LEFT», «MONO» and «RIGHT» start flashing.
5. Press «SELECT», until the indicator «LEFT» starts flashing.
6. Now press the volume control «+» on your remote twice.
7. «LEFT» now lights up permanently.
8. Press «SELECT» until the indicator «RIGHT» starts flashing.
9. Now press the volume control «->» on your remote twice.
10. «RIGHT» now lights up permanently.
11. Press «SELECT» until «MONO» starts flashing.
12. Now press «mute» on your remote twice.
13. «MONO» lights up permanently.
14. After 5 seconds all indicators light up.
15. Your remote has been successfully tuned.

YOU CAN EASILY SKIP INDIVIDUAL STEPS BY PRESSING THE «SELECT» BUTTON AGAIN.

The volume is automatically reduced after this process but can be set back to 100% with your remote control.

Note: Your TV remote or any IR remote can also be used with external devices such as CD and record players.

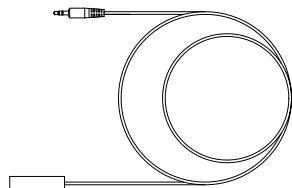

10 TV CONNECTIVITY OPTIONS

10.1 WISA WIRELESS

Some TV's have built-in WISA interfaces that allow setting up a wireless connection between your TV and your Ace speakers without any additional devices. If this is the setup of your choice, we recommend purchasing a minimum of two Rx speakers, then follow the operating instructions of your TV.

10.2 HDMI (e)ARC

If your TV has an HDMI (e)ARC output you can easily and conveniently connect your speakers by connecting your TV to the «HDMI eARC» input on your Ace Tx.

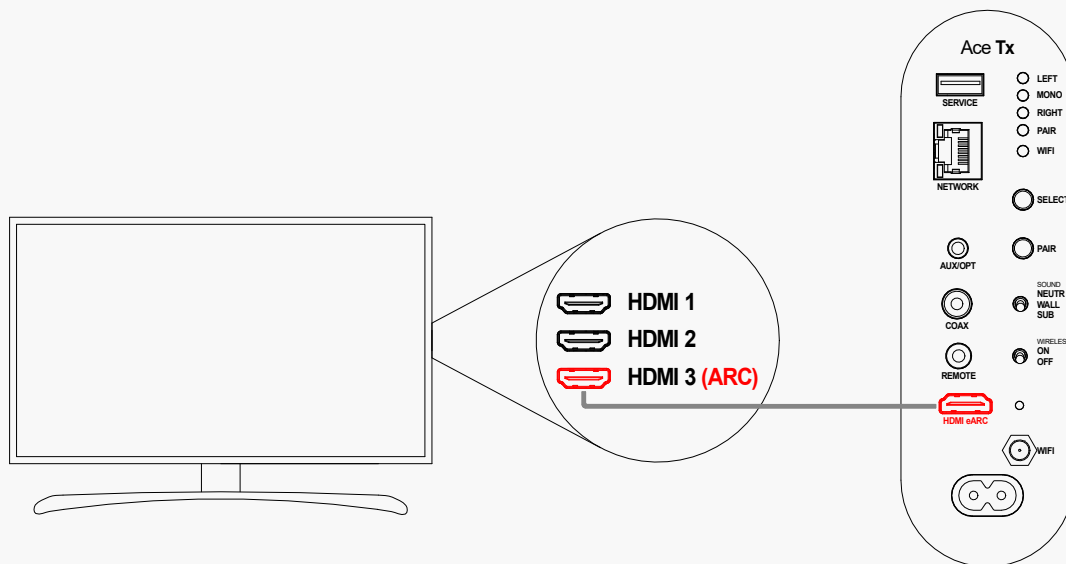

Double-check the settings on your TV to make sure the sound is played back through the HDMI ARC output.

Note: The Ace Tx only support stereo signals. For multi-channel (home cinema) playback, an appropriate external WISA transmitter must be used.

10.3 FURTHER CONNECTIVITY

You can also transmit the TV audio signal digitally to your Ace speakers using an optical or coaxial cable. Or simply: analog.

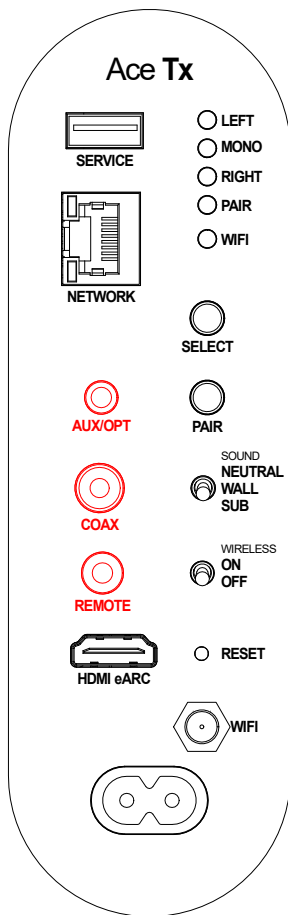

Note: For both options use the «AUX/OPT» jack on the rear panel. A corresponding adapter for the optical connection is included in the scope of delivery.

These TV outputs often miss the volume information. We therefore recommend to connect the enclosed external IR receiver («REMOTE») and tune your TV remote in order to control the volume. Learn more: [VOLUME CONTROL BY REMOTE](#)

11 BLUETOOTH CONNECTION

The built-in Bluetooth function is not protected, meaning that anyone can pair with your Ace speakers at any time using a Bluetooth-enabled device. If you wish to eliminate unwanted Bluetooth connections, you can protect the Bluetooth pairing mode and prevent your Ace speakers from automatically being detected by any Bluetooth-enabled device. You will then have to push «PAIR» before establishing a connection to your speakers.

11.1 BLUETOOTH PAIRING MODE

To switch between protected and unprotected Bluetooth pairing mode press «SELECT» and «PAIR» for more than 20 seconds.

Note: After approx. 5 seconds the indicators will go off, simply keep pressing until they'll light up again. Upon successfully switching the pairing mode all indicators «LEFT», «MONO» and «RIGHT» will light up 3 times. You can switch between the two pairing modes at any time.

12 AUTOMATIC INPUT SOURCE SELECTION

The Ace Tx automatically selects its input source, following a predefined prioritisation:

Input source	Priority
Streaming Clients · Google Chromecast · Spotify Connect · Roon Ready · Bluetooth	1*
HDMI eARC	2
Digital Coax	3
Analog (AUX)	4
Digital optical (OPT)	5

The input source with the higher priority is selected, sources with lower priority are suppressed. If the active source stops, the Tx automatically switches to a lower priority source after approx. 10 seconds.

*The highest priority lists multiple streaming clients but will always play the last one applied.

Eg.: 1. Music is played through Spotify Connect
2. A new stream is being started through Google Chromecast
3. Google Chromecast overrides and stops the Spotifystream

13 PIEGA WIRELESS SYSTEM

Besides audio signal transmission, the wireless connection between the Ace Tx and Ace Rx also enables communication with other products of the Ace series or a PIEGA wireless subwoofer. Therefore, the appropriate filters will be set automatically if connected with a PIEGA wireless subwoofer:

- **High-pass filter for the Ace speakers**
- **Low-pass filter for the subwoofer**

Volume and phasing can still be adjusted from the subwoofer. For further tips and information consult the PIEGA wireless subwoofer user guide.

14 RESET

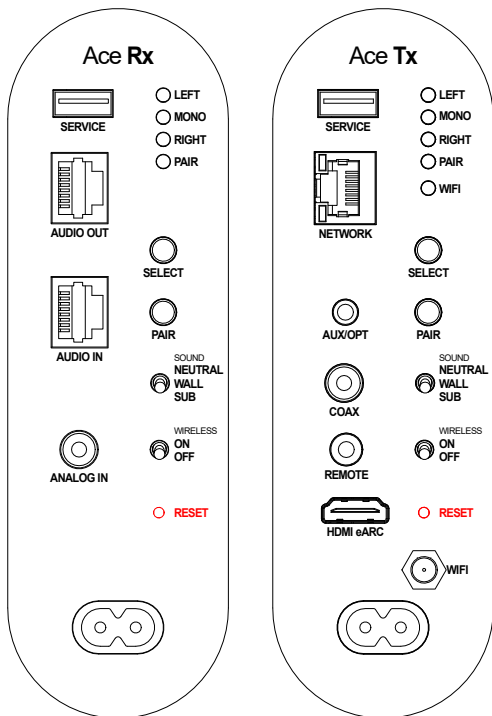

To perform a reset to factory default use a pointed object to push the «RESET» button on the rear panel of your speaker. The following settings will be deleted:

Ace Tx	Ace Rx
Network settings (Connection to LAN/WLAN)	WiSA connection (Connection to WiSA TV or Tx speaker)
WiSA connection (Connection to Rx speaker)	
IR remote tuning	
Bluetooth setting (Pairing mode)	

15 FIRMWARE-UPDATE

To perform a firmware update, follow the steps below:

15.1 UPDATE YOUR RX

1. Disconnect your speakers from the power supply.
2. Save the new firmware on a memory stick.
3. Connect the memory stick to the USB «SERVICE» port.
4. Power your speakers.
5. The «PAIR» indicator lights up, flashing red throughout the entire update.
6. Speaker will reset and resume normal operation

Note: Make sure to save the new firmware to the top level of your memory stick and refrain from using subfolders.

15.2 UPDATE YOUR TX

Firmware updates are usually installed via Google Chromecast running automatically in the background. Alternatively, an update can be started at any time through the web interface or via memorystick:

15.2.1 WEBINTERFACE UPDATE

1. Connect to your speaker and access the web interface.
2. On the web interface click on «Upgrade» in the «Firmware Upgrade» section.
3. Choose the firmware file (83_IMAGE_NETWORK) and press «Upgrade».
4. This process may take a few minutes.
5. You'll find the current software version in the section «Firmware Upgrade». This version is updated upon successful installation.

Note: If your web browser won't automatically reconnect after the software update, simply re-enter your speaker's IP address in the browser.

15.2.2 MEMORYSTICK UPDATE

1. Disconnect your speakers from the power supply.
2. Save the new firmware to a memory stick.
3. Connect the memory stick to the USB «SERVICE» input.
4. Supply your speakers with power.
5. Flip the Wireless Switch to "ON". For the update, the speaker must be started up to 100%, which can take up to 1 minute.
6. The «WIFI» indicator flashes red and blue during the entire update process.

Note: Be sure to save the firmware at the top level on your memory stick and do not use subfolders.

16 SETUP INTERFACE FOR AUDIOPHILES

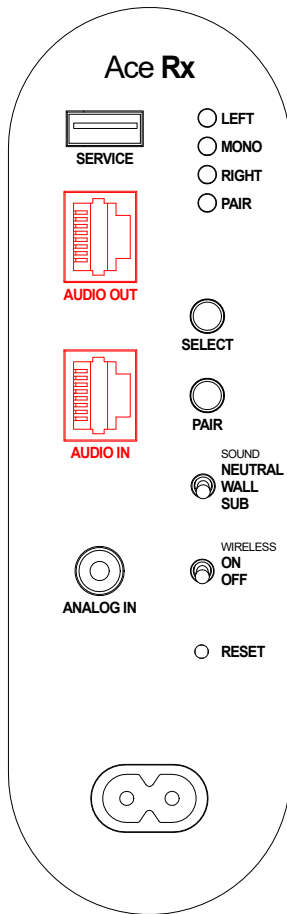

The Ace Rx speakers are equipped with a balanced analog input (stereo). The built-in RJ45 jacks allow for inexpensive and easy installation, and the signal can be routed via standard CAT network cables. It is imperative to use shielded cables and RJ45 plugs. The following graph provides an overview of the pin assignment of the RJ45 connector.

RJ45 Pin	Input	Polarity
1	Balanced Analog Left	+
2	Balanced Analog Left	-
3	NOT connected	
4	Balanced Analog Right	-
5	Balanced Analog Right	+
6	Ground	GND
7	NOT connected	
8	Ground	GND
GND	All	GND

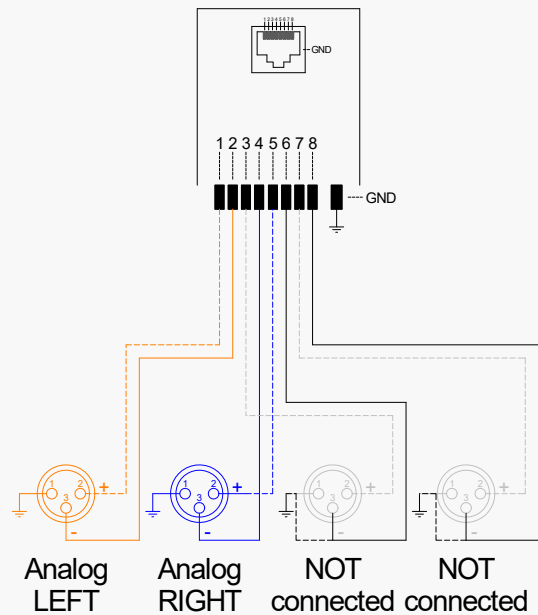

The signal is internally routed from RJ45 «AUDIO IN» to RJ45 «AUDIO OUT».

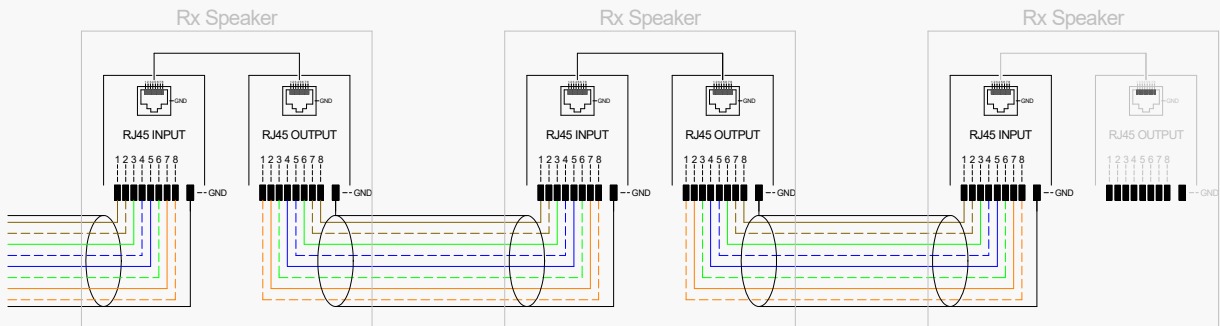

Note: Make sure the «WIRELESS» switch is «OFF»: see [WIRELESS ON/OFF](#)

The stereo configurations, such as the setting of the «SOUND» switch, are also supported in this setup.
See [STEREO CONFIGURATION](#).

17 LED INDICATORS AT A GLANCE

LED indicator						
LEFT	MONO	RIGHT	PAIR	Wi-Fi	Function	Description
ON	OFF	OFF	–	–	Stereo setting	The left channel is active.
OFF	ON	OFF	–	–	Stereo setting	Mono (left + right) is active.
OFF	OFF	ON	–	–	Stereo setting	The right channel is active.
–	–	–	Flashing	–	WiSA	The speakers connect to each other or to a WiSA device.
–	–	–	ON	–	WiSA	A connection between two speakers or speaker and WiSA device has been established.
–	–	–	–	Flashing green	Wi-Fi	Tx speaker searches/connects to LAN/WLAN.
–	–	–	–	ON green	Wi-Fi	Tx speaker is connected to LAN/WLAN.
OFF	OFF	OFF	ON red	OFF	Mode	Speaker is in stand-by mode.
3 × ON/ OFF	3 × ON/ OFF	3 × ON/ OFF		–	Bluetooth	Bluetooth pairing mode has been selected..
Flashing	Flashing	Flashing		–	IR remote	IR remote ready for tuning.
Flashing	OFF	OFF		–	IR remote	IR remote activating volume control «+».
OFF	Flashing	OFF		–	IR remote	IR remote activating «Mute».
OFF	OFF	Flashing		–	IR remote	IR remote activating volume control «-».

18 TECHNICAL DATA

Supported streaming protocols			
Google Chromecast Spotify connect Roon Ready DLNA Bluetooth 4.2			
Supported streaming protocols		WiSA	
WLAN standard	IEEE 802.11a/b/g/n & 802.11ac Dual band 2.4GHz / 5.8GHz	Data rate Tx to Rx	48 – 96kHz / 24Bit
Maximum resolution	192kHz (24Bit)		
Wired inputs		Wired inputs	
Tx Analog (Stereo) 48kHz / 24Bit Optical/Coax (S/PDIF) 192kHz / 24Bit HDMI eARC		Rx Analog RCA 48kHz / 24Bit Analog Stereo Balanced 48kHz / 24Bit	
Supply			
Voltage	100 – 240V 50/60Hz		

	Ace 50 Wireless	Ace 30 Wireless	Ace Center Wireless
Frequency response	30Hz – 25kHz	35Hz – 25kHz	35Hz – 25kHz
Amplifier power @ <1% THD	200W	100W	100W
Maximum input power	250W	130W	130W
Equipping	PIEGA AMT Tweeter 1 x 120mm MDS midrange 4 x 120mm MDS bass	PIEGA AMT Tweeter 1 x 120mm	PIEGA AMT Tweeter 2 x 120mm
Dimensions	105 x 14 x 16cm Stand 25cm (Diameter)	20 x 14 x 16cm	14 x 34 x 16cm
Weight	14kg / 16kg (Alu / White and Black)	3.4kg	5kg

19 DECLARATION OF CONFORMITY

PIEGA AMP speaker is in conformity with the following directives:

LVD:2014/35/EU

EMC:2014/30/EU

RED:2014/53/EU

ERP:2009/125/EU

ROHS:2011/65/EU

REACH:1907/2006/CE

STANDBY

After 60 minutes without any incoming music, the speaker will automatically go into a network standby mode. This is indicated by a red light on operating status display, and the power consumption goes down to 0.5 W. The speaker will automatically wake up upon receiving a music signal, but we encourage you to completely turn off your speaker when not in use for an extended period of time.