

NU-VISTA 600

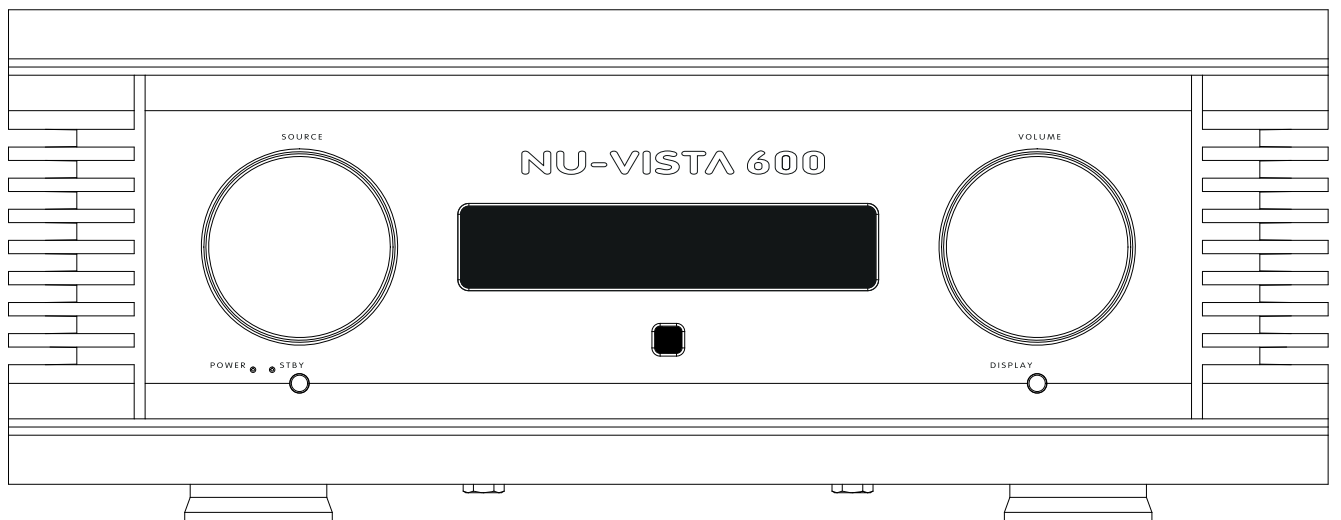

Instructions for use

Thank you for purchasing the Musical Fidelity Nu-Vista 600 integrated amplifier.

The Nu-Vista 600 uses our tried and tested ultra-low distortion power amplifier circuitry, which has enough current reserve to drive even the most demanding speakers with ease. The low noise and distortion, high-quality Nu-Vista preamplifier uses valve circuits used in our original Nu-Vista products, redesigned, to fulfil our latest practices and expectations. This completes the integrated amplifier giving a perfect sound from a great looking full size unit.*

The Nu-Vista 600 will aesthetically match with present and future Nu-Vista series products. Such a combination will yield one of the best high-fidelity systems available at any price.

Used properly and carefully, it should give many years of outstanding musical reproduction.

Dust regularly with a soft duster or soft brush, but be careful when using cleaning or polishing agents - they may harm the surface finish.

If there are any questions about the audio system, please consult the dealer, who is there to help and advise.

NU-VISTA 600

CUTAWAY VIEWS

Showing Cylindrical Electrodes and Tripod-Like Supports

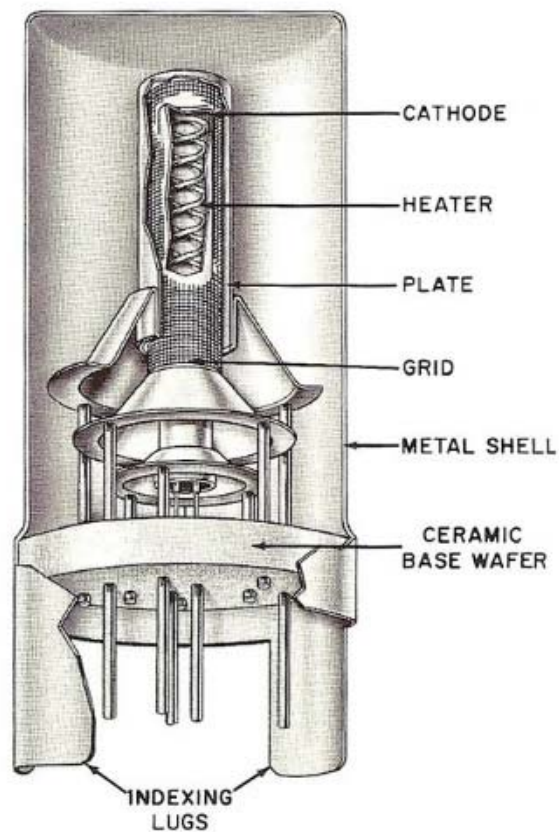

Typical
Single-Ended
Nuvistor Triode

** UK English "valve" mentioned hereafter, refers to the 'electron valve' kind, also known as electron "tube" in other parts of the world.*

Section		Page
Safety Information	– Mains plug (UK only), modification warning	4
General advice	– Installation precautions	5
Installation	– Introduction, cleaning, installation, power connections, audio connections	6
Facilities and connections	– Illustrations, main unit front & rear panels	7
Remote control handset	– Operation and illustration	8
Operation	– Starting	9
	– Volume	
	– Mute	
	– CD	
	– AUX1/HT	
	– AUX2	
	– TUNER	
	– Balanced	10
	– Illuminations	
	– Wiring	11
Problems?	– Basic fault finding	12
Specifications	– Product specifications	13
Manual history		14
Item disposal information		

IMPORTANT! (U.K. only)

This unit is supplied in the U.K. with mains lead fitted with a moulded 13 amp plug. If, for any reason, it is necessary to remove the plug, please remove the fuse holder and dispose of the plug safely, out of reach of children.

It must not be plugged into a mains outlet.

The wires in the mains lead supplied with this appliance are coloured in accordance with the following code:

Green and yellow	Earth
Blue	Neutral
Brown.....	Live

WARNING – This appliance MUST be earthed

As the colours of the wires of the mains lead of this appliance may not correspond with the coloured markings identifying the terminals in the plug, proceed as follows:

- The wire which is coloured green-and-yellow must be connected to the terminal in the plug which is marked with the letter E or coloured green or green-and-yellow, or by the earth symbol: 
- The wire which is coloured brown must be connected to the terminal which is marked with the letter L or coloured red.
- The wire which is coloured blue must be connected to the terminal which is marked with the letter N or coloured black.
- If connecting to a BS1363 plug, a 13 amp fuse must be used.

WARNING:

ANY MODIFICATIONS TO THIS PRODUCT NOT EXPRESSLY APPROVED BY MUSICAL FIDELITY WHO IS THE PARTY RESPONSIBLE FOR STANDARDS COMPLIANCE COULD VOID THE USER'S AUTHORITY TO OPERATE THIS EQUIPMENT.

Installation, Precautions & User Information

This new Nu-Vista 600 is designed and built to provide trouble-free performance, but as with all electronic devices it is necessary to observe a few precautions:

- Heed all warnings shown on the back of the product.
- Only connect the Nu-Vista 600 to a mains outlet having the same voltage as marked at the back of the unit.
- Always ensure that when disconnecting and reconnecting your audio equipment the mains supply is switched off.
- Position the mains lead and signal interconnects where they are not likely to be walked on or trapped by items placed on them.
- Do not use near water, or place water-filled containers on the Nu-Vista 600, for example, a flower vase or potted plants. **If water does spill inside, immediately pull out the mains plug from the wall socket and inform your dealer, who should then check the unit before further use. Entry of liquid into the Nu-Vista 600 is dangerous, and may cause electric shock or fire hazard.**
- Do not place the unit near direct heat sources such as radiators, direct sunlight or other equipment.
- Do not remove any covers or try to gain access to the inside. There are no internal adjustments or fuses you can replace yourself. Refer all service work to an authorised Musical Fidelity agent.
* **Note: Unauthorised opening of the equipment will invalidate any warranty claim.**
- Dust regularly with a soft cloth or soft brush but be careful when using cleaning or polishing agents - they may harm the surface finish.

The electronics in modern hi-fi equipment is complex and may, therefore, be adversely affected or damaged by lightning. For protection of the audio system during electrical storms, remove the mains plugs.

If after-sales service is required, to help the dealer identify the Nu-Vista 600 please quote the serial number located on the rear panel of the unit.

Introduction

Congratulations on the purchase of the new Nu-Vista 600 integrated amplifier. Great attention has been paid to internal layout, isolating each circuit section to prevent possible interaction. The unit features a finely tuned and tweaked Nu-Vista valve preamplifier, for smooth sound coupled with low noise and virtually no distortion.

The power amplifier consists of two top quality power amplifiers for the absolute best in separation and imaging. Generously rated, they are enough to drive even the most demanding loudspeakers with ease. Low distortion and very quiet they will deliver all music types exactly as the artist originally intended.

The resultant performance achieved by this unit is among the best in the world. It has excellent signal to noise ratio, low distortion, wide bandwidth and dynamic range, with extraordinary resolution and fine detail.

Cleaning

Before cleaning the unit, switch off power at the mains switch and remove the mains plug from the wall socket. Clean the cabinet and remote control unit using a moist cloth. Using solvents, white spirit or thinners is not advised, as they could damage the surface finish.

Installation

Position the Nu-Vista 600 on a stable, horizontal surface where there is no risk of it being knocked, or subjected to vibration such as from loudspeakers.

Important note:

During normal operation, the unit dissipates an appreciable quantity of power at all times, and it is important that it is well ventilated. The top and bottom are perforated to allow the smooth flow of heat through the unit. However, the unit must not be enclosed in a cabinet or placed where the ventilation holes are impeded as this could result in excessive heat build-up.

The Nu-Vista 600 must be protected from humidity – if the unit is moved from a cold place to a warm room, leave the unit for an hour or so to allow sufficient time for the moisture to evaporate.

Power Connections

The Nu-Vista 600 is supplied with a standard IEC mains cable which plugs into the IEC socket at the back of the unit (see page 7). When plugged in and mains supply is present the orange STDBY LED will light.

Audio Connections

RCA Inputs: Connect all RCA single-ended sources to relevant analogue inputs (see page 7 for more information). Use good quality fully connected (signal and ground) coaxial phono cables for all RCA signal connections. Take care with positioning all input leads, try to ensure that they are well shielded and kept as far away from mains and speaker leads as possible.

XLR Balanced inputs: Connect source balanced outputs to Nu-Vista 600 balanced inputs using good quality XLR balanced leads. Recommended lead wiring is shown on P.7. Note some products simply connect “cold” input pin 3 to ground. This does no harm to unit, but may result in an audible reduction in signal level from this input and a slightly worse signal to noise ratio.

Speaker Outputs: Connect loudspeakers to the terminals on the back panel marked as **LEFT** and **RIGHT SPEAKER** outputs. See “WIRING” P.11 for more details.

LINE output sockets allow loop through of analogue signals for example, to pass on to a recorder or monitor. It is also the ideal output to connect headphone amps into (headphone amplifier will require its own volume control to allow listening level adjustment). This output is the currently selected source but level is *not* changed by the front panel volume control.

PRE-OUT output sockets allow analogue signals controlled by the volume, to pass on to, for example, an external power amplifier. This is useful for bi-amping or active “subwoofer” connection where volume out needs to be controlled by the Nu-Vista 600 front panel volume knob.

NU-VISTA 600 FACILITIES & CONNECTIONS

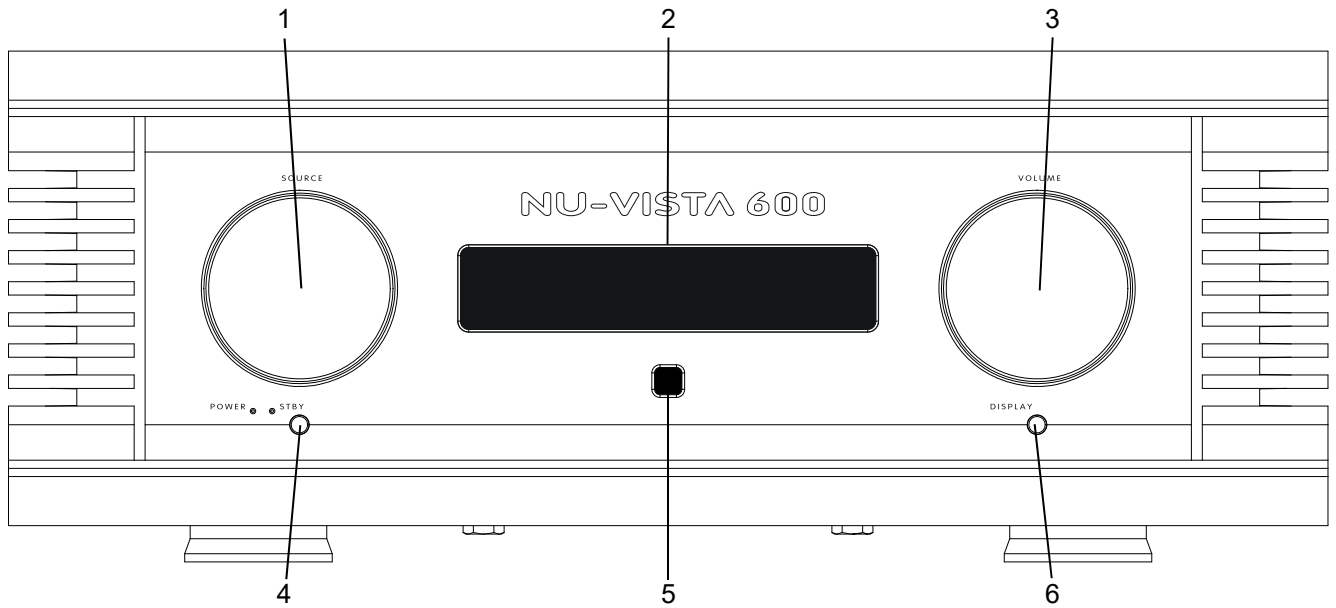

- 1 **SOURCE** selector
- 2 **DISPLAY**
- 3 **VOLUME** control
- 4 **ON/STANDBY** Button
- 5 **IR RECEIVER** window
- 6 **DISPLAY AND LED** functions button

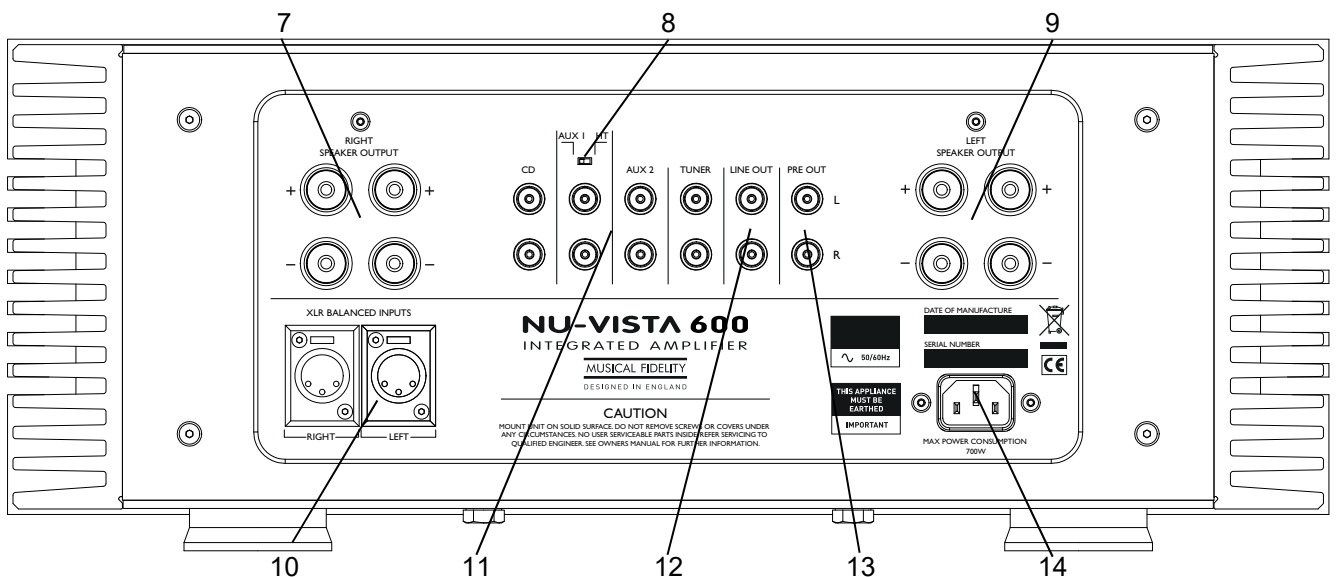

- 7 **LOUDSPEAKER OUTPUTS** right
- 8 **HT/AUX** function selector for **AUX1/HT** input
- 9 **LOUDSPEAKER OUTPUTS** left
- 10 **XLR BALANCED** inputs left and right
- 11 **CD, AUX1/HT, AUX2, TUNER** line input RCA sockets
- 12 **LINE OUT** (fixed) output RCA sockets
- 13 **PRE OUT** (volume controlled) output RCA sockets
- 14 **IEC MAINS INPUT**

XLR Balanced input and output lead connections:



(for reference, no XLR signal leads supplied)

Pin functions:

- 1 Ground (cable shield)
- 2 Normal polarity ("hot" or "+")
- 3 Inverted polarity ("cold" or "-")

The universal remote control shown below enables functions from this and related units to be operated from a convenient distance.

Equivalent buttons on the remote control have the same functions as those on the front panel of the unit. Other functions are only available by remote control.

As the handset uses an invisible infra-red light beam, the front edge must be pointed directly towards the receiver window at the front of the player, without visual obstruction between them.

If the range of the remote control greatly decreases, replace the batteries with new ones. Do not mix old and new batteries – two are required, size AAA, LR03 or SUM-4.

Please dispose of used batteries in accordance to local regulations.

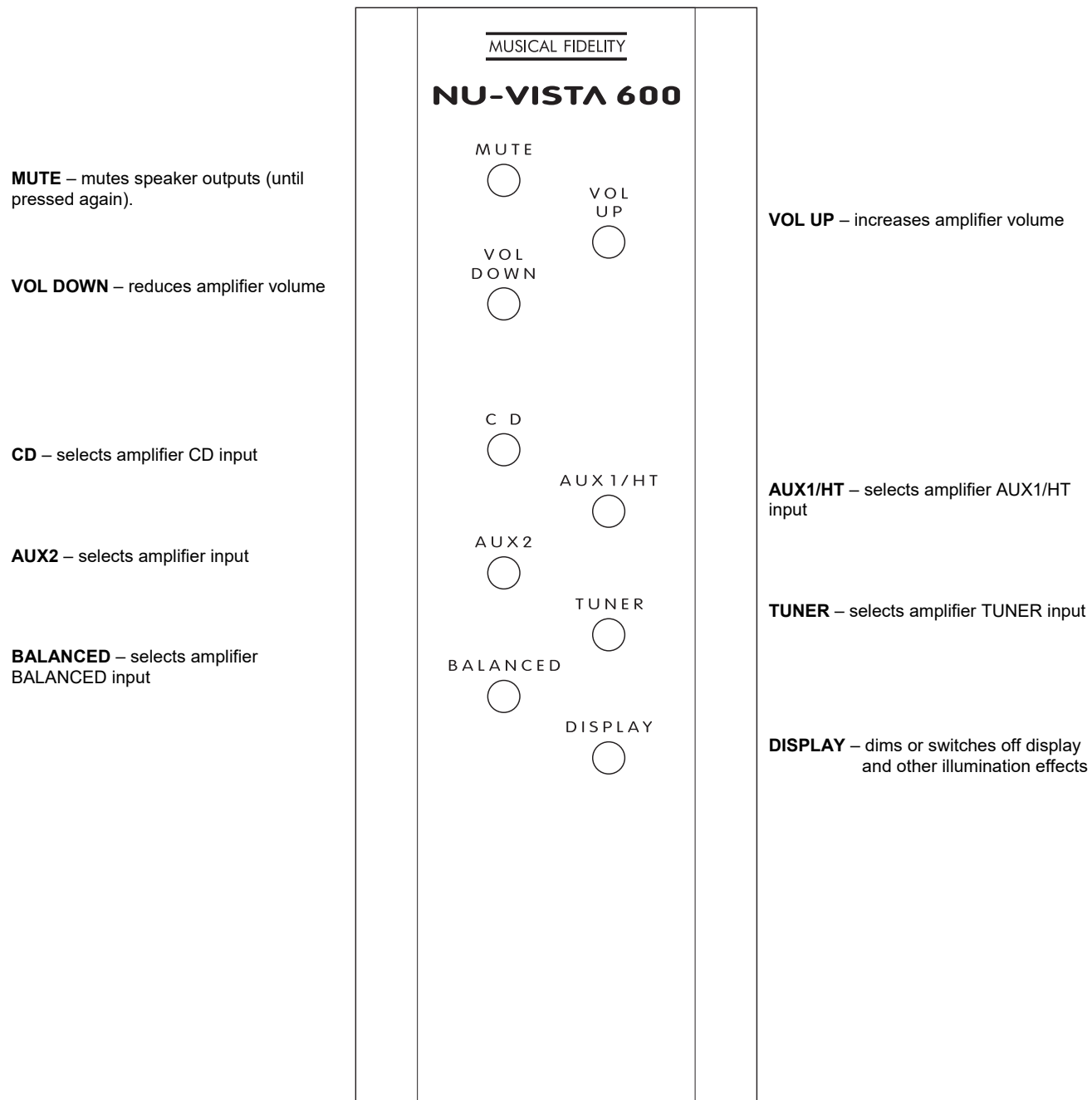

Starting

Once all connections are made, switch on the unit, using the **POWER** button front of the unit. The display will light up and base LEDs (under front panel) will show RED. This means the speaker outputs are muted, and will remain in this state for about 12 seconds, so no sound will be heard from the speakers. Once the delay is up, the base LEDs go green, indicating unit is ready for use, and any source material selected and playing will be heard through the speakers.

For the first 15 mins or so, the Nu-Vista valves are still warming up, and the valve illumination will be yellow in colour. After approx. 20 mins the valves will have reached full thermal equilibrium and are at their best performance, which is indicated by the illumination turning green.

Volume

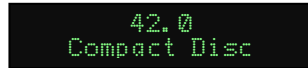

The volume should be adjusted for normal listening levels. This is done by turning the volume up/down knob on the front panel.

Adjusting the volume can also be achieved by pressing the volume up/down buttons on the remote control handset (see page 8).

Mute (Remote Control only)

The sound from the speakers may be muted by use of the **MUTE** button on the remote (see page 8).

Press once, and LEDs under the unit and illumination around the valves will light RED indicating muted state. No sound will be heard from the speakers.

To return to listening; simply press the **MUTE** button again so LEDs are no longer red.

Compact Disc

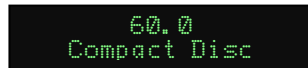

To use the Compact Disc input, connect Compact Disc player outputs to the **CD** input RCA sockets (see page 7). Select **Compact Disc** input by rotating the source select control so **Compact Disc** is displayed.

Pressing the corresponding button on the remote handset has the same effect (see page 8).

Auxiliary 1/Home Theatre

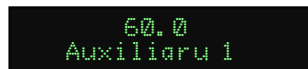

- (1) To use the **Auxiliary 1/Home Theatre** input as a standard input, move the **AUX / HT** switch on the back panel to the **AUX** position. Connect source outputs to the **AUX 1 / HT** input RCA sockets (see page 7). Select **Auxiliary 1/Home Theatre** input by rotating the source select control so **Auxiliary 1** is displayed. Pressing the corresponding button on the remote handset has the same effect (see page 8).



- (2) To use the **AUX1/HT** input as a Home Theatre input, move the **AUX / HT** switch to the **HT** position. This input is now unaffected by the volume control, allowing volume control on an external Home Theatre processor to be used directly. Connect home theatre or other source outputs to the **AUX1/HT** input RCA sockets (see page 7). Select **AUX 1/HT** input by rotating the source select control so **Home Theatre** is displayed.

IMPORTANT: Take great care when using the input in HT mode. Ensure that the volume control is turned right down on the **HT processor** when first setting up. The HT mode is designed for sources which require their own volume control to be used. Connecting sources in HT mode with no volume control could result in damage to hearing and/or speakers due to uncontrolled loud sounds.

If **Home Theatre** mode is not going to be used, always leave the **AUX / HT** switch in the **AUX** position

Auxiliary 2

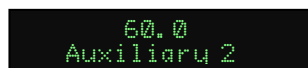

To use the **Auxiliary 2** input, connect source outputs to the **AUX 2** input RCA sockets (see page 7).

Select **Auxiliary 2** input by rotating the source select control so **Auxiliary 2** is displayed.

Pressing the corresponding button on the remote handset has the same effect (see page 8).

Tuner



To use the **Tuner** input, connect tuner outputs to the **TUNER** input RCA sockets (see page 7). Select **Tuner** input by rotating the source select control so **Tuner** is displayed. Pressing the corresponding button on the remote handset has the same effect (see page 8).

Balanced

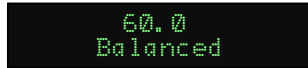

To use the **Balanced** input, connect source balanced outputs to the **XLR BALANCED INPUTS** sockets (see page 7). Select **Balanced** input by rotating the source select control so **Balanced** is displayed. Pressing the corresponding button on the remote handset has the same effect (see page 8).

ILLUMINATIONS

When used in darker environments, for example listening or home theatre rooms. It is possible to switch off selected features to minimise distraction.

The illumination features (excluding the power/standby LEDs) can be switched on or off by pressing the DISPLAY button on the front panel.

There is also a corresponding button on the remote control. To cover all options, all 4 permutations are available for use, tabulated below.

STEP	DISPLAY	VALVE ILLUMINATION
1 (default)	ON	ON
2	OFF	ON
3	ON	OFF
4	OFF	OFF

To select the desired step, simply press the DISPLAY button on the front panel or remote until the required step is reached. After step 4, the unit reverts back to step 1.

Please note, switching off the unit will store the current step. When next switched on, the remembered setting will be overridden temporarily until after the initial 12 second mute delay. Once the delay is up, the unit will revert to normal operation but with the step setting as previously selected.

Simple speaker lead wiring

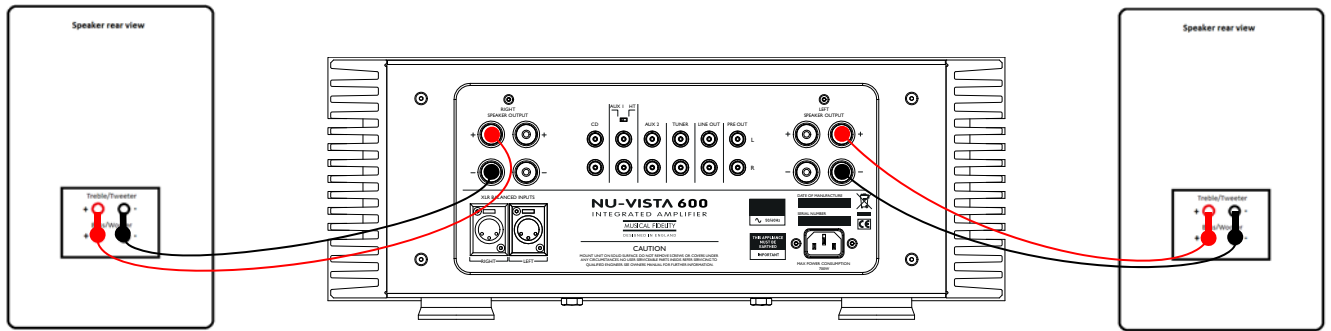

Bass/treble terminal links in

(source and mains leads omitted for clarity)

Bass/treble terminal links in

Speaker lead bi-wiring

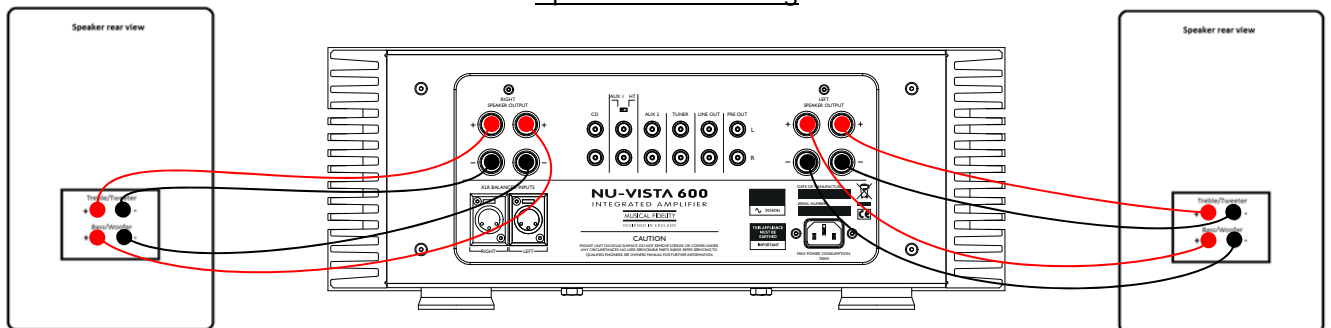

|| Bass/treble terminal links removed

(source and mains leads omitted for clarity)

|| Bass/treble terminal links removed

Speaker bi-amping (requires additional power amplifier)

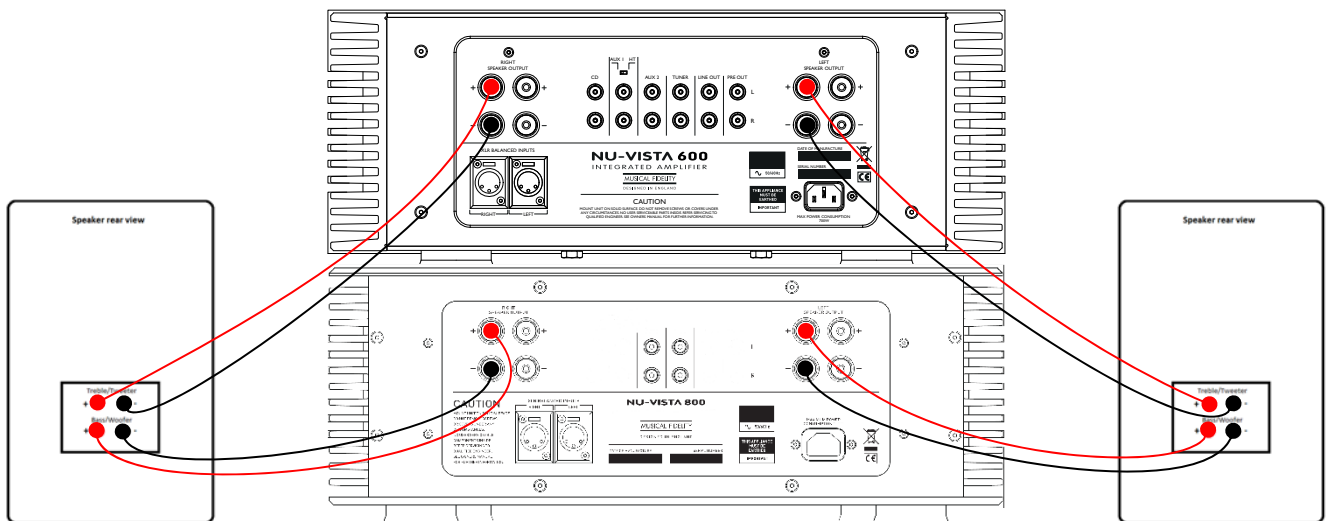

|| Bass/treble terminal links removed

(source and mains leads omitted for clarity)

|| Bass/treble terminal links removed

Basic problem-solving with an amplifier is similar to troubleshooting other electrical or electronic equipment. Always check the most obvious possible causes first, such as the following examples:

Problem	Probable Cause	Remedy
No power when POWER button is pressed.	Mains power plug is not fully inserted into rear socket.	Plug in securely.
No sound	Mute function is still active. Wrong connections between input sources and the unit Speakers not connected, or incorrectly wired	Press the MUTE button on the remote control to cancel. Check audio input lead connections. Check speaker cables.
Sound cut	Loose connection Output overload or short circuit	Check speaker and input connections. Switch unit off. Check speaker connections for shorting strands or wires. When all has been double-checked reduce volume and switch unit back on. N.B. Take great care when bi-wiring or bi-amping that speaker bass and treble linking straps are removed; see speaker manual for more information.
Sound is not precise, lacking in bass and stereo image.	Speakers are connected out of phase, i.e., connections to one speaker (+ and -) are reversed.	Ensure speakers are connected with same polarity at amplifier and speaker ends.
Hum.	Audio connector plug not fully pushed in Cable Fault Unsuitable cable (e.g. cable grounds not connected)	Insert plug securely. Check cable is connected at both ends. N.B. Some esoteric cables have internal wiring intentionally disconnected/modified. For best results on all inputs analogue AND digital, please use good quality screened coax; signal and screens both separately connected at both ends.
No audio output, or too low level output.	Incorrect or missing connections	Check connections and make sure they are secure.
Remote control does not work.	Amplifier's POWER off. One or more batteries fitted the wrong way round. Batteries are flat. Remote control is not pointed directly towards the front panel of the amplifier. Interference from another source.	Switch on. Insert batteries correctly. Change batteries for a new set. Ensure there is no obstruction between the remote control and amplifier front. Lighting such as fluorescent, incandescent, or even sunlight contains large amounts of infra-red radiation. Ensure such sources are not shining directly on the infra-red window as this could swamp the signal from the remote control. Also check the system and any other nearby remotes for stuck buttons.
Remote control range has greatly reduced	Batteries are running out	Change batteries for a new set.

If none of these actions affect a cure, please contact the dealer, or an authorised Musical Fidelity service agent. Remember; never open the case of the Nu-Vista 600, as this will invalidate the guarantee.

Output

Power	200 Watts per channel into 8 Ohms
Voltage	42 Volts RMS, 20Hz to 20 kHz; onset of clipping
	119 Volts peak to peak
Current	120 Amps peak to peak
Damping factor	200
Output devices	2 pairs per channel

Line input

THD+N	< 0.005 % typical, 20Hz to 20 kHz
Signal / noise ratio	> 103dB 'A'-weighted
Input impedance	40 k Ohms
Frequency response	+ 0, -0.1dB, 10Hz to 30 kHz

Connections

Line level inputs	4 pairs line level RCA connectors 1 pair line level balanced XLR connectors
Line level outputs	1 pair line level RCA connectors, constant level LINE outputs 1 pair line level RCA connectors, PREAMP outputs for e.g. biamping
Speaker outputs	2 pairs 4mm banana plug/binding posts

Power requirement

Mains voltages	115/230VAC 50/60Hz (factory pre-set) 100VAC 50/60Hz (alternative)
Consumption	<0.5W in standby mode (orange LED lit) 130W on and idle (blue LED lit) 700 Watts maximum

Weight

Unit only, unboxed	31 kg (68 ¹ / ₅ lbs)
in shipping carton	47 kg (107 ⁴ / ₅ lbs)

Maximum Dimensions

Wide	483 mm (19")
Height on standard flat feet	187 mm (7 ¹ / ₃ ")
on pointed feet	212 mm (8 ¹ / ₃ ")
Deep (front to back) including terminals	510 mm (15 ³ / ₄ ")

Standard accessories

IEC type mains lead	10-Amp type
Remote control	Nu-Vista 600 Integrated remote
Batteries	LR03 or AAA, manganese alkaline type 2 off
Felt pads	4 off
Spike Foot	4 off
Spike Foot Cups	4 off
Remote Feet	4 off

Musical Fidelity reserves the right to make improvements which may result in specification or feature changes without notice.



RELEASE	DATE	CHANGES
Issue 01	14/7/2016	1 st Issue



DISPOSAL

The crossed out wheeled bin label that appears on the back panel of the product indicates that the product must not be disposed of as normal household waste. To prevent possible harm to the environment please separate the product from other waste to ensure that it can be recycled in an environmentally safe manner. Please contact local government office or retailer for available collection facilities.



DISPOSITION

La poubelle sur roulettes barrées X, qui apparaît en logo sur le panneau arrière du produit, indique que celui-ci ne doit pas être traité comme un déchet domestique commun. Afin de protéger l'environnement, ce produit électronique devra être géré séparément et donc recyclé selon les nouvelles normes Européennes Rohs concernant les déchets d'appareils électroniques. Prière de contacter les services concernés gouvernementaux ou votre point de vente pour l'élimination et l'enlèvement de déchets électroniques équipés de composants électroniques.



DISPOSAL

La etiqueta cruzada hacia fuera del compartimiento que aparece en el panel trasero del producto indica que el producto no se debe reciclar como basura normal de la casa. Para prevenir daños posible al ambiente separe por favor el producto de otra basura para asegurarse de que puede ser reciclada de una manera ambientalmente segura. Entre en contacto por favor a su oficina gubernamental local o a su minorista para las instalaciones disponibles de la colección.



RIFIUTI

L'etichetta del cassonetto barrato riportato sul retro dell'apparecchio indica che il prodotto non deve essere smaltito tramite la procedura normale di smaltimento dei rifiuti domestici. Per evitare eventuali danni all'ambiente, separare questo prodotto da altri rifiuti domestici in modo che possa venire riciclato in base alle procedure di rispetto ambientale. Per maggiori dettagli sulle aree di raccolta disponibili, contattate l'ufficio govenativo locale od il rivenditore del prodotto.



FACHGERECHTE ENTSORGUNG:

Das auf der Geräterückseite angebrachte Label deutet darauf hin, dass das Produkt nicht mit konventionellem Hauskehricht entsorgt werden darf. Um Schäden und Verschmutzungen an Umwelt und Mensch zu vermeiden, muss das Produkt fachgerecht entsorgt und von anderem Abfall getrennt werden. Wenden Sie sich bei Fragen hierzu an Ihren Fachhändler oder an eine öffentliche Informationsstelle.



AFVAL

Het label op de achterzijde van dit apparaat, een afvalbak op wielen met een kruis doorgehaald, geeft aan dat dit apparaat niet samen met gewoon huishoudafval mag worden weggegooid. Om mogelijke schade aan onze leefomgeving te voorkomen dient dit apparaat, gescheiden van gewoon huishoudelijk afval, te worden afgevoerd zodat het op een milieuvriendelijke manier kan worden gerecycled. Neem voor beschikbare inzamelplaatsen contact op met uw gemeentelijke reinigingsdienst of met uw elektronica leverancier.



HÄVITTÄMINEN

Yliüksattua jäteastiaa kuvaava tarra tuotteen takalevyssä kertoo, että tuotetta ei saa käsitellä normaalina talousjätteenä. Ympäristön suojelemiseksi on tuote pidettävä erillään muusta jätteestä ja se on kierrätettävä ekologisesti kestävällä tavalla. Ota yhteyttä laitteen myyjään tai Pirkanmaan Ympäristökeskukseen lähimmän kierrätyskeskuksen löytämiseksi.



AFSKAFNING

Logoet med en skraldespand med kryds over på bagsiden af apparatet indikerer at dette produkt ikke må kasseres som normal husholdningsaffald. For at forebygge mulig skade på miljøet, bedes De separere dette produkt fra andet affald, og sikre at det bliver genbrugt på en miljørigtig måde. Kontakt venligst de lokale myndigheder eller din forhandler for oplysning om nærmeste tilgængelige opsamlingssted for elektronikaffald.



ΔΙΑΔΙΚΑΣΙΑ ΑΠΟΡΡΙΨΗΣ

ΤΟ ΣΗΜΑ ΜΕ ΤΟΝ ΔΙΑΓΕΓΡΑΜΜΕΝΟ ΤΡΟΧΗΛΑΤΟ ΚΑΔΟ ΑΠΟΡΡΙΜΑΤΩΝ ΣΤΗΝ ΠΙΣΩ ΟΨΗ ΤΟΥ ΜΗΧΑΝΗΜΑΤΟΣ

ΔΗΛΩΝΕΙ ΟΤΙ ΤΟ ΠΡΟΙΟΝ ΑΥΤΟ ΔΕΝ ΠΡΕΠΕΙ ΝΑ ΔΙΑΧΕΙΡΙΣΘΕΙ ΣΑΝ ΣΥΝΗΘΙΣΜΕΝΟ ΟΙΚΙΑΚΟ ΑΠΟΒΛΗΤΟ.

ΠΡΟΣ ΑΠΟΦΥΓΗ ΕΝΔΕΧΟΜΕΝΗΣ ΕΠΙΒΑΡΥΝΣΗΣ ΤΟΥ ΠΕΡΙΒΑΛΛΟΝΤΟΣ, ΞΕΧΩΡΙΣΤΕ ΤΟ ΠΡΟΙΟΝ ΑΠΟ ΤΑ ΆΛΛΑ ΑΠΟΡΡΙΜΑΤΑ ΩΣΤΕ ΝΑ ΕΞΑΣΦΑΛΙΣΘΕΙ Η ΑΝΑΚΥΚΛΩΣΗ ΤΟΥ ΜΕ ΤΟΝ ΠΡΕΠΟΝΤΑ ΤΡΟΠΟ.

ΠΑΡΑΚΑΛΟΥΜΕ ΝΑ ΕΠΙΚΟΙΝΩΝΗΣΕΤΕ ΜΕ ΤΗΝ ΤΟΠΙΚΗ ΥΠΗΡΕΣΙΑ ΑΝΑΚΥΚΛΩΣΗΣ Η ΜΕ ΤΟ ΚΑΤΑΣΤΗΜΑ ΑΓΟΡΑΣ ΓΙΑ ΠΕΡΙΣΣΟΤΕΡΕΣ ΛΕΠΤΟΜΕΡΕΙΕΣ.