

AXR85 AXR100
STEREO RECEIVER

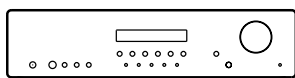

Contents

IMPORTANT SAFETY INSTRUCTIONS	3
LIMITED WARRANTY	4
REAR PANEL CONNECTIONS	5
FRONT PANEL CONTROLS	6
REMOTE CONTROL	7
CONNECTIONS	8
AERIALS	10
OPERATING INSTRUCTIONS	10
TECHNICAL SPECIFICATIONS	12
TROUBLESHOOTING	12

This guide is designed to make installing and using this product as easy as possible. Information in this document has been carefully checked for accuracy at the time of printing; however, Cambridge Audio's policy is one of continuous improvement, therefore design and specifications are subject to change without prior notice.

This document contains proprietary information protected by copyright. All rights are reserved. No part of this manual may be reproduced by any mechanical, electronic or other means, in any form, without prior written permission of the manufacturer. All trademarks and registered trademarks are the property of their respective owners.

© Copyright Cambridge Audio Ltd 2018..

Make sure you register your product at:
WWW.CAMBRIDGEAUDIO.COM/REGISTER

For upcoming news on future products, software updates and exclusive offers.

Important safety instructions

For your own safety please read the following important safety instructions carefully before attempting to connect this unit to the mains power supply. They will also enable you to get the best performance from and prolong the life of the unit:

1. Read these instructions.
2. Keep these instructions.
3. Heed all warnings.
4. Follow all instructions.
5. Do not use this apparatus near water.
6. Clean only with a dry cloth.
7. Do not block any ventilation openings. Install in accordance with the manufacturer's instructions.
8. Do not install near any heat sources such as radiators, heat registers, stoves, or other apparatus (including amplifiers) that produce heat.
9. Do not defeat the safety purpose of the polarized or grounding-type plug. A polarized plug has two blades with one wider than the other. A grounding-type plug has two blades and a third grounding prong. The wide blade or the third prong are provided for your safety. If the provided plug does not fit into your outlet, consult an electrician for replacement of the obsolete outlet.
10. Protect the power cord from being walked on or pinched, particularly at plugs, convenience receptacles and the point where they exit from the apparatus.
11. Only use attachments/accessories specified by the manufacturer.
12. Use with only the cart, stand, tripod, bracket, or table specified by the manufacturer, or sold with the apparatus. When a cart is used, use caution when moving the cart/apparatus combination to avoid injury from tip-over. 
13. Unplug this apparatus during lightning storms or when unused for long periods of time.
14. Refer all servicing to qualified service personnel. Servicing is required when the apparatus has been damaged in any way, such as the power-supply cord or plug having been damaged, liquid has been spilled or objects have fallen into the apparatus, the apparatus has been exposed to rain or moisture, does not operate normally, or has been dropped.

WARNING

- To reduce the risk of fire or electric shock, do not expose this unit to rain or moisture.
- Batteries (battery pack or batteries installed) shall not be exposed to excessive heat such as sunshine, fire or the like.

The unit must be installed in a manner that makes disconnection of the mains plug from the mains socket outlet (or appliance connector from the rear of the unit) possible. Where the mains plug is used as the disconnect device, the disconnect device shall remain readily operable. Only use the mains cord supplied with this unit.

Please ensure there is ample ventilation (at least 10cm clearance all round). Do not put any objects on top of this unit. Do not situate it on a rug or other soft surface and do not obstruct any air inlets or outlet grilles. Do not cover the ventilation grilles with items such as newspapers, tablecloths, curtains, etc.

This unit must not be used near water or exposed to dripping or splashing water or other liquids. No objects filled with liquid, such as vases, shall be placed on the unit.

Use of the apparatus in tropical climates - The equipment shall be used at a maximum 45 degree C ambient temperature.

The unit is of Class 1 construction and must be connected to a mains socket outlet with a protective earthing connection.



The lightning flash with the arrowhead symbol within an equilateral triangle is intended to alert the user to the presence of un-insulated 'dangerous voltage' within the product's enclosure that may be of sufficient magnitude to constitute a risk of electric shock to persons.

The exclamation point within an equilateral triangle is intended to alert the user to the presence of important operating and maintenance instructions in the service literature relevant to this appliance.



WEEE SYMBOL

The crossed-out wheeled bin is the European Union symbol for indicating separate collection for electrical and electronic equipment. This product contains electrical and electronic equipment which should be reused, recycled or recovered and should not be disposed of with unsorted regular waste. Please return the unit or contact the authorised dealer from whom you purchased this product for more information.



CE MARK

This product complies with European Low Voltage (2006/95/EC), Electromagnetic Compatibility (2004/108/EC) and Environmentally-friendly design of Energy-related Products (2009/125/EC) Directives when used and installed according to this instruction manual. For continued compliance only Cambridge Audio accessories should be used with this product and servicing must be referred to qualified service personnel.



RCM (REGULATORY COMPLIANCE MARK)

This product meets the Safety, EMC and Radio Communications requirements of the ERAC and ACMA.



CU-TR Mark

This product meets Russia, Byelorussia and Kazakhstan electronic safety approvals.

VENTILATION

IMPORTANT - The unit will become hot when in use. Do not stack multiple units on top of each other. Do not place in an enclosed area such as a bookcase or in a cabinet without sufficient ventilation.

Ensure that small objects do not fall through any ventilation grille. If this happens, switch off immediately, disconnect from the mains supply and contact your dealer for advice.

POSITIONING

Choose the installation location carefully. Avoid placing it in direct sunlight or close to a source of heat. No naked flame sources, such as lighted candles, should be placed on the unit. Also avoid locations subject to vibration and excessive dust, cold or moisture. The unit can be used in a moderate climate.

This unit must be installed on a sturdy, level surface. Do not place in a sealed area such as a bookcase or in a cabinet. Do not place the unit on an unstable surface or shelf. The unit may fall, causing serious injury to a child or adult as well as serious damage to the product. Do not place other equipment on top of the unit.

Due to stray magnetic fields turntables or CRT TVs should not be located nearby due to possible interference.

Electronic audio components have a running in period of around a week (if used several hours per day). This will allow the new components to settle down, the sonic properties will improve over this time.

POWER SOURCES

The unit should be operated only from the type of power source indicated on the marking label. If you are not sure of the type of power-supply to your home, consult your product dealer or local power company.

This unit can be left in Standby mode when not in use and will draw <0.5W in this state. **To turn the unit off, switch off at the rear panel.** If you do not intend to use this unit for a long period of time, unplug it from the mains socket.

OVERLOADING

Do not overload wall outlets or extension cord as this can result in a risk of fire or electric shock. Overloaded AC outlets, extension cords, frayed power cords, damaged or cracked wire insulation, and broken plugs are dangerous. They may result in a shock or fire hazard.

Be sure to insert each power cord securely. To prevent hum and noise, do not bundle the interconnect leads with the power cord or speaker leads.

CLEANING

To clean the unit, wipe its case with a dry, lint-free cloth. Do not use any cleaning fluids containing alcohol, ammonia or abrasives. Do not spray an aerosol at or near the unit.

BATTERY DISPOSAL

Please dispose of any discharged batteries according to local environmental/electronic waste disposal guidelines.

LOUDSPEAKERS

Before making any connections to loudspeakers, make sure all power is turned off and only use suitable interconnects.

SERVICING

These units are not user serviceable, never attempt to repair, disassemble or reconstruct the unit if there seems to be a problem. A serious electric shock could result if this precautionary measure is ignored. In the event of a problem or failure, please contact your dealer.

FEDERAL COMMUNICATIONS COMMISSION

Supplier's declaration of conformity (SDoC)

Equipment(s): Stereo Receiver
Model(s): AXR85, AXR100
Trademark: Cambridge Audio

This device complies with Part 15 of the FCC Rules. Operation is subject to the following two conditions: (1) this device may not cause harmful interference, and (2) this device must accept any interference received, including interference that may cause undesired operation.

The responsible party in US:

Company name: Audio Partnership LLC

Address: 1913 N Milwaukee Ave. Chicago, IL 60647

Phone: (312) 636-4817

Legal Representative Person: Gregg Chopper

Signature: 

FCC STATEMENT

This device complies with Part 15 of the FCC Rules. Operation is subject to the following two conditions: (1) this device may not cause harmful interference, and (2) this device must accept any interference received, including interference that may cause undesired operation.

FEDERAL COMMUNICATIONS COMMISSION NOTICE:

This equipment has been tested and found to comply with the limits for a Class B digital device, pursuant to Part 15 of the FCC Rules. These limits are designed to provide reasonable protection against harmful interference in a residential installation.

This equipment generates, uses, and can radiate radio frequency energy, and if not installed and used in accordance with the instructions, may cause harmful interference to radio communications. However, there is no guarantee that interference will not occur in a particular installation.

If this equipment does cause harmful interference to radio or television reception, which can be determined by turning the equipment off and on, the user is encouraged to try and correct the interference by one or more of the following measures:

- Reorient or relocate the receiving antenna.
- Increase the distance between the equipment and the receiver.
- Connect the equipment to an outlet on a circuit different from that to which the receiver is connected.
- Consult the dealer or an experienced radio/TV technician for help.

FCC CAUTION: Any changes or modifications not expressly approved by the party responsible for compliance could void the user's authority to operate this equipment.

RF EXPOSURE STATEMENT:

To maintain compliance with FCC's RF Exposure guidelines. This equipment should be installed and operated with a minimum distance of 20cm between the radiator and your body. Use only the supplied antenna.

MODIFICATIONS:

The FCC requires the user to be notified that any changes or modifications to this device that are not expressly approved by Cambridge Audio, may void the user's authority to operate the equipment.

CANADA-INDUSTRY CANADA (IC)

This radio transmitter has been approved by Industry Canada.

This device complies with Industry Canada's license-exempt RSSs.

Operation is subject to the following two conditions.

(1) this device may not cause interference and (2) this device must accept any interference, including interference that may cause undesired operation of the device.

This equipment should be installed and operated with a minimum distance of 20cm between the radiator and your body.

The transmitter must not be co-located or operating in conjunction with any other antenna or transmitter.

The device meets the exemption from the routine evaluation limits in section 2.5

of RSS 102 and compliance with RSS-102 RF exposure, users can obtain Canadian information on RF exposure and compliance.

INDUSTRIE CANADA (IC)

Le présent appareil est conforme aux CNR d'Industrie Canada applicables aux appareils radio exempts de licence. L'exploitation est autorisée aux deux conditions suivantes :

(1) l'appareil ne doit pas produire de brouillage, et (2) l'utilisateur de l'appareil doit accepter tout brouillage radioélectrique subi, même si le brouillage est susceptible d'en compromettre le fonctionnement.

Cet équipement doit être installé et utilisé à une distance minimale de 20 cm entre le radiateur et votre corps.

L'émetteur ne doit pas être co-placé ni fonctionner en conjonction avec une autre antenne ou transmetteur.

Le dispositif rencontre l'exemption des limites courantes d'évaluation dans la section 2.5 de RSS 102 et la conformité à l'exposition de RSS-102 rf, utilisateurs peut obtenir l'information canadienne sur l'exposition et la conformité de rf.

EUROPE-EUROPEAN UNION NOTICE

Hereby, Audio Partnership PLC declares that this product is in compliance with Directive 2014/53/EU, the full text of the EU declaration of conformity is available at the following internet address:
<https://www.cambridgeaudio.com/DoC>

Bluetooth Radio Frequency:

2.402 GHz-2.48 GHz The Max. transmit power: 10dBm

PLUG FITTING INSTRUCTIONS (UK ONLY)

The cord supplied with this appliance is factory fitted with a UK mains plug fitted with a 5 amp fuse inside. If it is necessary to change the fuse, it is important that a 5 amp one is used. If the plug needs to be changed because it is not suitable for your socket, or becomes damaged, it should be cut off and an appropriate plug fitted following the wiring instructions below. The plug must then be disposed of safely, as insertion into a mains socket is likely to cause an electrical hazard. Should it be necessary to fit a 3-pin BS mains plug to the power cord the wires should be fitted as shown in this diagram. The colours of the wires in the mains lead of this appliance may not correspond with the coloured markings identifying the terminals in your plug. Connect them as follows:

The wire which is coloured BLUE must be connected to the terminal which is marked with the letter 'N' or coloured BLACK.

The wire which is coloured BROWN must be connected to the terminal which is marked with the letter 'L' or coloured RED.

The wire which is coloured GREEN/YELLOW must be connected to the terminal which is marked with the letter 'E' or coloured GREEN.

If a 13 amp (BS 1363) plug is used, a 5 amp fuse must be fitted, either in the plug or adaptor, or on the distribution board.

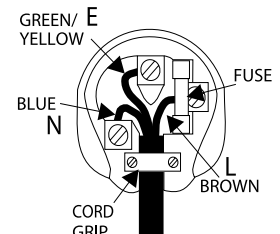

Rear panel connections

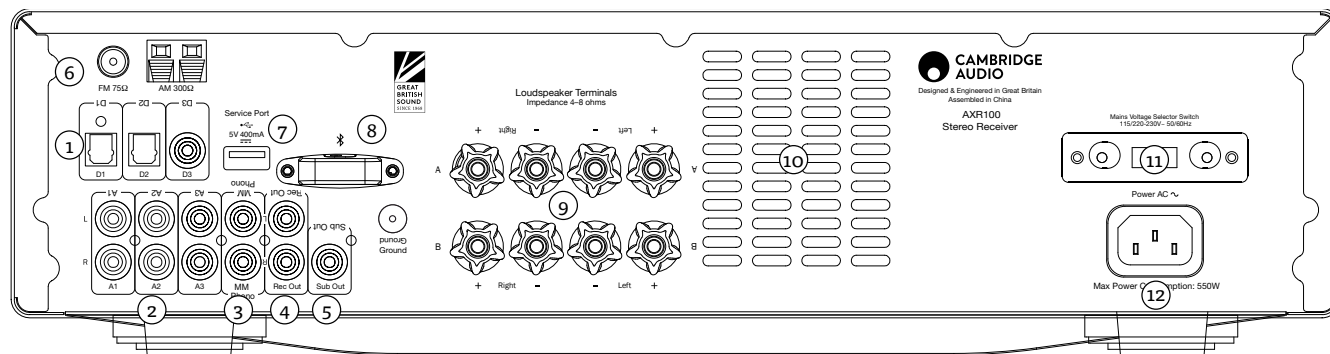

① DIGITAL INPUTS (AXR100 ONLY)

Toslink and S/P DIF co-axial digital inputs.

Note: To obtain the best results from your system we recommend using only high quality Cambridge Audio interconnects. This will ensure that you hear your system as we designed it. Please ask your dealer for details.

② AUDIO INPUTS

These inputs are suitable for any 'line level' source equipment such as the audio outputs of CD players, BD/DVD players, etc.

③ PHONO INPUT

This input has a built in phono stage. Record players fitted with Phono Cartridges of the Moving Magnet (MM) or high output Moving Coil (MC) type (between 2-6mV output and 30-50k load impedance) can be used. Low output Moving Coil types (<1mV and usually 10-1000 ohm load impedance) cannot be directly connected and will require a matching transformer or head amp. Please consult your dealer for details. The 'ground' terminals on both the record player and the **AXR** should be connected (where possible) with a ground wire for lowest noise/hum pickup.

④ REC OUT

Connect to the recording input of a tape deck, CD recorder input, etc.

⑤ SUB-OUT

For optional connection to the input socket of an active subwoofer if desired.

⑥ AM/FM ANTENNA

Tuner aerial connections for picking up radio signals. Refer to the 'Connections' section of this manual. For permanent use, outdoor AM/FM aerials are highly recommended.

⑦ SERVICE PORT

For servicing use only. Do not connect anything here as it may result in damage.

⑧ BLUETOOTH ANTENNA

Used for wireless streaming bluetooth (A2DP/AVRCP) audio capability directly from most phones, tablets and laptops. See later section for details.

⑨ LOUDSPEAKER TERMINALS

Two sets of loudspeaker terminals are available, A (main loudspeaker terminals, top row) and B (secondary switchable loudspeaker terminals, bottom row). Connect the wires from your left channel loudspeaker to the Left positive and negative terminals, and the wires from the right channel loudspeaker to the Right positive and negative terminals. In each case, the red terminal is the positive output and the black terminal is the negative output.

Care should be taken to ensure no stray strands of wire are shorting speaker outputs together. Please ensure that the loudspeaker terminals have been tightened adequately to provide a good electrical connection. It is possible for the sound quality to be affected if the screw terminals are loose.

The use of A and B speakers affords you an easy and inexpensive way to create a simple multi-room system.

Note: When using two pairs of speakers, use speakers with a nominal impedance of 16 ohms.

⑩ HEAT TUNNEL VENT GRILLE

Allows cooling of internal circuitry via the heat tunnel. **DO NOT OBSTRUCT!**

⑪ VOLTAGE SELECT SWITCH

For servicing use only.

⑫ AC POWER SOCKET

Once all connections are complete, plug the AC power cable into an appropriate mains socket and turn the unit on.

Front panel controls

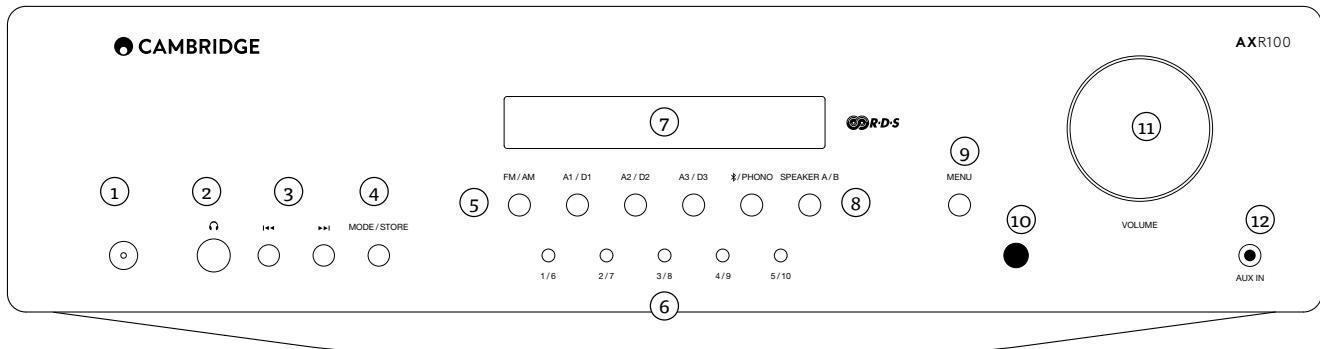

① STANDBY/ON

Switches the unit between Standby mode (indicated by dim power LED) and On (indicated by bright power LED). Standby is a low power mode where the power consumption is less than 0.5 Watts. The unit can be left in Standby mode when not in use.

This product has APD (Auto Power Down) enabled as default. After inactivity of 20 minutes, the product will automatically switch to Standby.

if you wish to disable the APD function, then press and hold the standby/on button for 5 seconds and the power LED will blink for 5 times when in On. Press and hold the standby/on button for 10 seconds and the power LED will blink for 10 times to enable the APD function

② HEADPHONES SOCKET

Allows for the connection of stereo headphones with a ¼ inch jack plug. Headphones with an impedance of between 32 and 600 ohms are recommended.

Note: Plugging in headphones will automatically mute the loudspeaker outputs.

③ SKIP/SCAN BUTTONS

The skip scan buttons are used when the FM/AM tuner is selected. These buttons have different uses depending on the mode selected:

In Preset mode - Steps up or down through the user-stored presets.

In Auto mode - Searches for the previous or next available station. The unit stops at the next strong signal it finds.

In Manual mode - Allows manual stepping up or down of the frequency.

Note: When Preset mode is activated, the unit will automatically tune to the first available preset.

④ MODE/STORE BUTTON

Used for AM/FM mode. Press to cycle the tuning mode between Preset, Auto, and Manual modes. Pressing and holding the button will allow the current selected station frequency to be stored in the preset bank. First press and hold the button then use the ◀ ▶ or Preset buttons to select the preset location for the station to be stored to. Press the Mode/Store button again to confirm and store the preset.

Note: In 'Store' mode, if no button is pressed for a while, the unit will come out of 'Store' mode and the preset will not be saved.

⑤ INPUT SOURCE BUTTONS (DIGITAL INPUTS D1, D2, D3 for AXR100 only)

Press the relevant source button to select the desired input source.

Note: The FM/AM source is built into the AXR. This button toggles between the FM mode and AM mode when pressed more than once.

The AXR has a built-in Bluetooth adaptor. This allows the AXR to receive wireless bluetooth audio from most phones, tablets or laptops.

⑥ PRESET BUTTONS

Used for AM/FM modes. The preset buttons are used to select user-stored station presets. Pressing a preset button once will select one of the first 5 preset, then pressing the same preset button again will toggle to the next preset (1 and then 6

for instance). These presets are stored separately for each waveband i.e. there are 10 for FM and 10 for AM press the FM/AM button to switch between bands and sets of 10 presets.

Note: As well as these 10 per band available directly from the front panel buttons a further 5 presets (11-15) per band can also be accessed by using the up/down buttons to cycle through all 15 presets.

⑦ DISPLAY

Used to display information such as the selected input source, volume and tone/balance levels. When the FM or AM tuner input is selected, the radio frequency or RDS station name will be displayed.

Note: When first purchased, the display will have a protective film over the top. Peel this off for a clear display.

⑧ SPEAKER A/B BUTTON

The Speaker A/B button toggles between the two sets of loudspeaker terminals. The options are speaker A only, speaker B only, speaker A and B together, and both sets of speakers off.

Note: 'Speaker off' is different to the mute function, as the Rec Out and Headphones outputs are still enabled.

⑨ MENU BUTTON

Pressing this once will select the Bass option. Pressing a second time will select the Treble option and pressing a third time will select the Balance option. When one of these options is selected, the volume control will adjust the level. If nothing is pressed for a while, the source will be displayed and the volume control will go back to controlling the volume level.

⑩ INFRARED SENSOR

Receives IR commands from the supplied remote control. An unobstructed line of sight between the remote control and the sensor is required.

⑪ VOLUME CONTROL

Use to increase or decrease the level of the sound from the outputs of the unit. This controls the volume level of the loudspeakers, Sub-out and headphones. It does not affect the level of the 'Rec Out' output. The volume control will also change the level of bass, treble and balance in the menu options.

⑫ AUX INPUT SOCKET

This source input allows you to connect a portable audio device such as an MP3 player directly into the front of the unit using a 3.5mm stereo-jack. Once plugged in, this input is automatically selected, although other inputs can still be selected once a stereo-jack is plugged in. The A1 button on the front of the unit will select this input whilst a stereo-jack is plugged in.

Note:

- Plugging a source into the front panel AUX input overrides the A1 input. Simply removing the jack from the front panel to automatically re-enable the A1 input.

- Also note that as the output level of MP3 players tends to be quite low, the AXR adds 6dB to the current volume setting when (and only when) the AUX input is selected.

Remote control

The **AXR** is supplied with a remote control that operates this unit and its built-in tuner. In addition, the buttons with Blue coloured icons can operate a matching **AX CD** player.

Always use Alkaline batteries.

STANDBY/ON

Switches the unit between Standby mode and On.

Mute

Mutes audio on the unit. Press again to cancel mute.

CD (BLUE COLOURED ICONS)

To operate the **AXC** players only. For more information refer to the **AX CD** user's manual.

SPEAKER A/B

Toggles between the selected loudspeaker terminals: speaker A only, speaker B only, speaker A and B together, or all speakers off.

STEREO/MONO

Used only when FM is selected. Toggles between FM stereo output and FM mono output. For low quality stereo FM signals, selecting mono can usually reduce the noise. Note: Some FM stations are mono only, and selecting Stereo will have no effect on these.

MODE

Used for AM/FM mode. Press to cycle the tuning mode between Preset, Auto, and Manual modes.

VOLUME

Increases or decreases the volume of the unit. Also used to change the bass, treble and balance settings when these are selected.

SKIP

Used when FM or AM is selected.

In Preset mode – Steps up or down through the user-stored presets.

In Auto mode – Search for the previous or next available station with a strong signal.

In Manual mode – Adjusts the frequency in steps, for fine tuning.

MENU

Toggles between Bass, Treble and Balance options. Use the volume buttons to change the level of the selected option.

PRESET BUTTONS (1/5, 2/6, 3/7, 4/8)

Used when FM or AM is selected. These select user-stored station presets. Pressing a preset button once will select one of the first 4 presets, then pressing the same preset button again will toggle to the next preset. 8 presets are available directly from the remote, further presets can be selected in Preset mode, by using the Skip/Scan buttons.

SOURCE BUTTONS (D1, D2, D3, A1, A2, A3/Aux, Phono, , AM/FM)

Press the relevant button to select the desired music source.

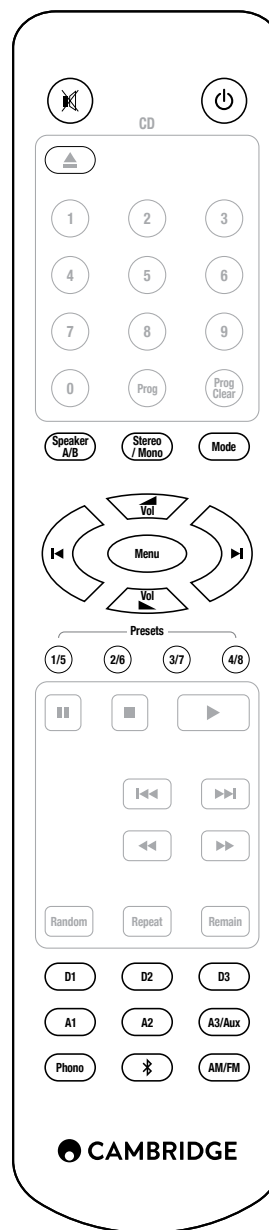

Connections

LOUDSPEAKERS

Check the impedance of your speakers. When using a pair of speakers, you can use types with an impedance of between 4 and 8 Ohms. When using two pairs of speakers, you must use types with an impedance of 8 Ohms each, see later section.

The red coloured speaker terminals are positive (+) and the black speaker terminals are negative (-). Make sure correct polarity is maintained at each speaker connector or the sound can become weak and "phasey" with little bass.

USING BARE WIRE CONNECTIONS

Prepare the speaker cords for connection by stripping off approximately 10mm (3/8") or less of the outer insulation. More than 10mm could cause a short circuit. Twist the wires tightly together so there are no loose ends. Unscrew the speaker terminal, insert the speaker cable, tighten the terminal and secure the cable.

Note: All connections are made using standard loudspeaker cable.



BASIC CONNECTION

The diagram below shows the basic connection of your unit to a CD player and a turntable and a pair of loudspeakers.

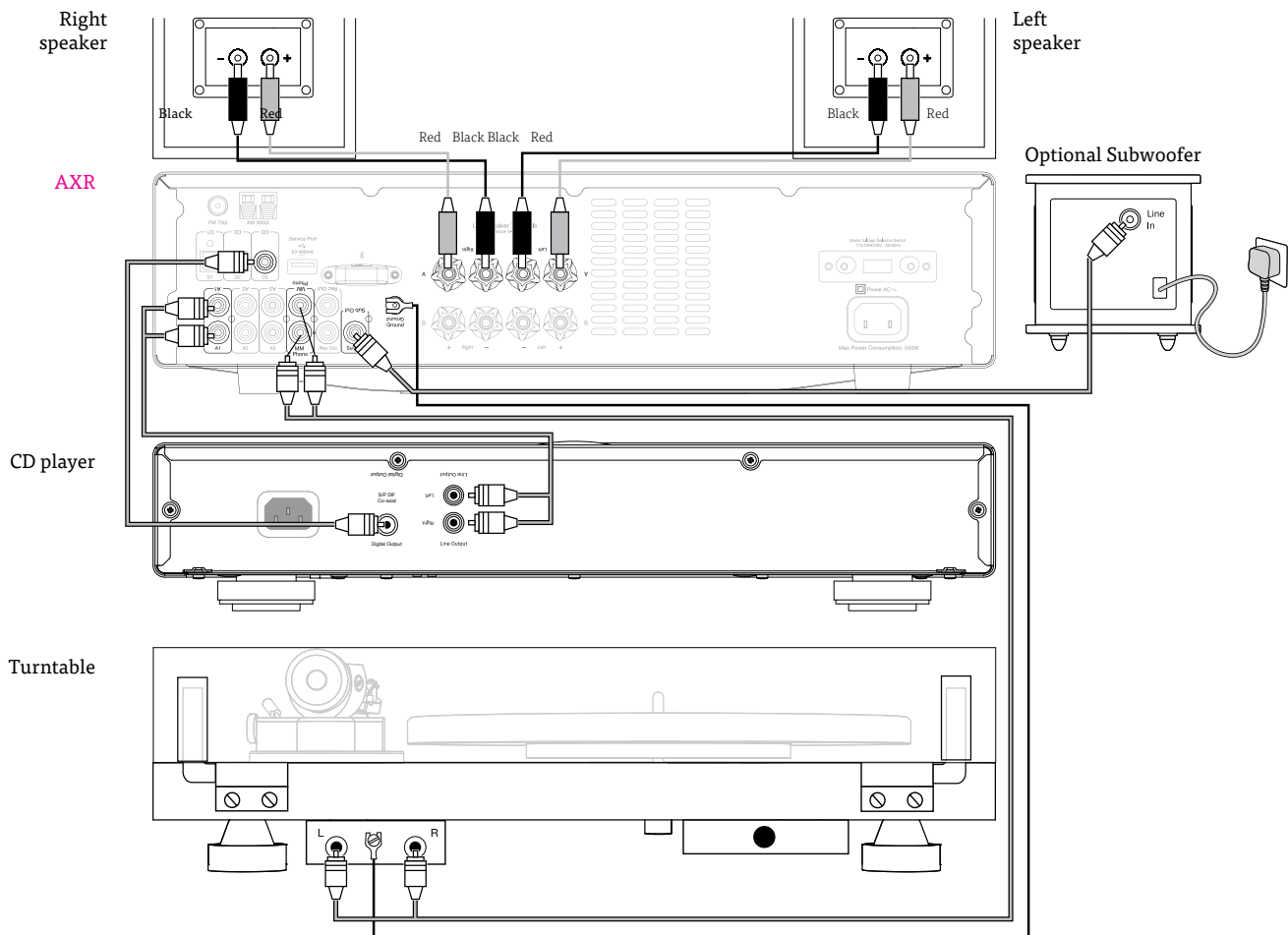

SPEAKER B CONNECTIONS

The Speaker B connections on the back of the amplifier allow for a second set of speakers to be used (i.e. speakers located in another room). The Speaker A/B button on the front panel and remote control allows the two sets of speakers to be toggled on and off. Refer to the Front Panel or Remote Control section of this manual for more information on the Speaker A/B operation.

Either A or B, or both A and B may be selected for use.

Note: When using two pairs of speakers, use speakers with a nominal impedance of 16 ohms each.

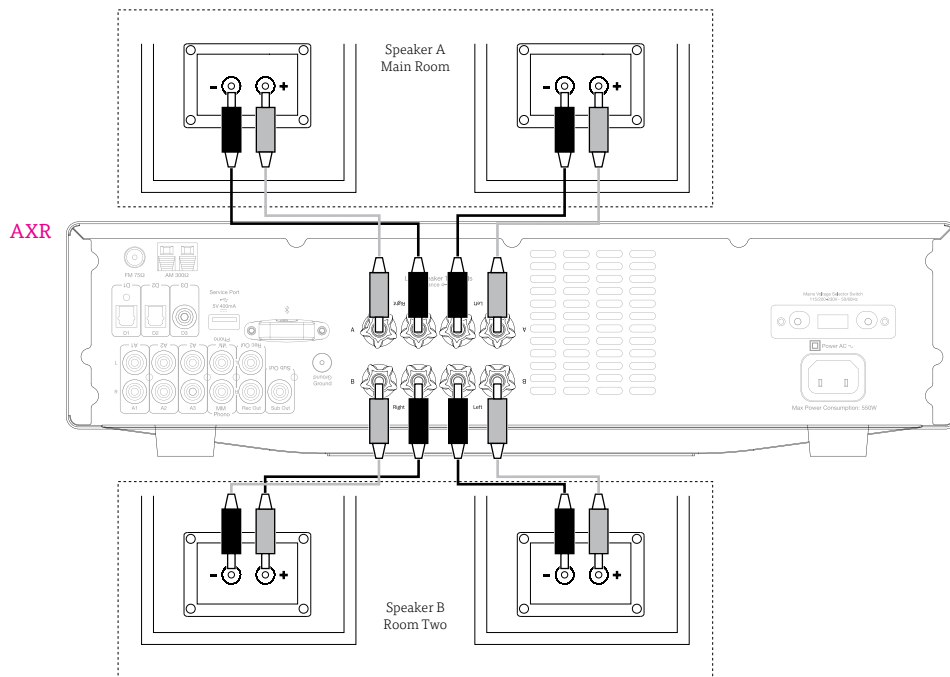

BI-WIRE CONNECTIONS

If your loudspeakers are equipped with two sets of terminals, then it is possible to connect them in the bi-wire configuration. Bi-wiring sends the bass and treble frequencies down separate speaker cables, resulting in a clearer, more focussed sound.

Note:

- Speaker A and B must both be selected for this type of connection to work.
- Remove the bi-wire link on the speaker terminals before connecting. Refer to your speakers' manual for more information.

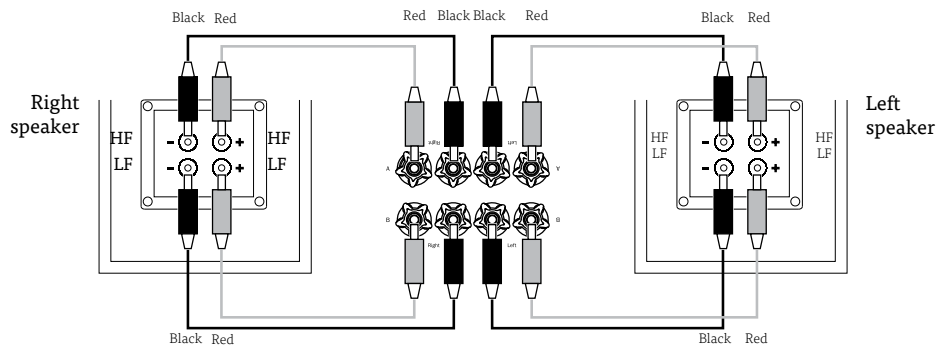

Aerials

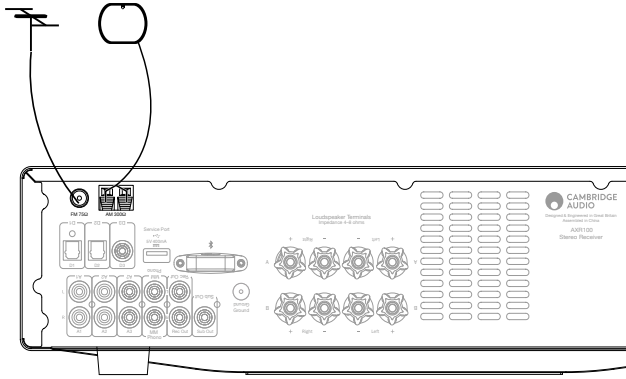

Note: The AXR is supplied with a temporary aerial for initial use. For permanent use, outdoor aerials are highly recommended.

AM LOOP AERIAL

Connect each end of the single length antenna to the antenna terminals. Place the antenna as far from the main system as possible to prevent unwanted noise and to obtain optimum reception. If the AM loop aerial provided does not provide sufficient reception, it may be necessary to use an outdoor AM aerial.

FM AERIAL

Connect the supplied aerial to the FM 75 ohm socket. Extend and move the aerial lead around until you get the best reception. For continued use, we strongly recommend using a 75 ohm outdoor FM aerial.

Operating instructions

After making any connections to your unit, activate the **AXR** by pressing the **Standby/On** button on the front of the unit.

SETTING THE SOURCE

Press the Source button on the front of the unit corresponding to your desired source. Alternatively, you may use the appropriate button on the remote control.

BLUETOOTH

To connect a Bluetooth device to AXR.

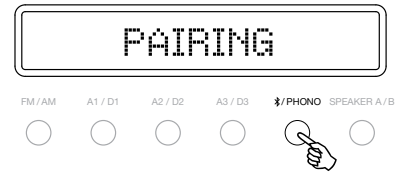

1. Press the **Phono** button or the remote. "PAIRING" will show on the display.
2. Consult the instructions of the Bluetooth device to connect to AXR. When successfully connected the display will show your device name.

To add another Bluetooth device, Press and hold the **Phono** button to disconnect the current connection and repeat step 2. AXR will store up to 8 paired devices in memory.

ADJUSTING THE VOLUME

Use either the Volume Up/Down buttons on the remote control, or the Volume control on the front of your unit system to change the volume level. The newly selected level will be indicated briefly on the front display.

The volume is displayed in minus dB where 0dB is the highest level.

A progressively larger negative number indicates the volume is being reduced.



ADJUSTING THE AUDIO SETTINGS

Adjustments to the bass, treble and balance can be made as follows:

1. To enter the audio menu. Press either the Menu button on the front of the unit or on the remote control.

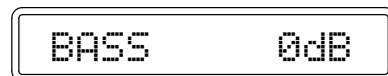

2. Step through the available settings by pressing the Menu button. The settings available are in order Bass, Treble and Balance.

3. When you wish to make an adjustment for bass, treble or balance, simply rotate the Volume control or use the Volume control buttons on the remote control.

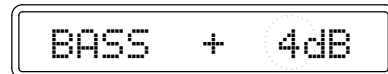

4. To exit, wait for five seconds, until the unit returns to normal mode.

TUNING AND LISTENING TO THE BUILT IN TUNER

Select the Tuner source using the FM/AM button on the front of the unit, or directly by pressing the FM or AM buttons on the remote.

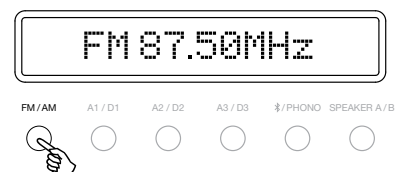

Repeatedly pressing the FM/AM button on the front of the unit switches between FM and AM modes.

Note: For ease of tuning on first time use, we recommend that you set the **AXR** to 'Auto' mode. Press the Mode/Store button on the front of the unit. This button cycles through Preset, Auto and Manual, modes.



MODE/STORE



When Auto mode has been selected, press the ◀ button to scroll down through the station frequencies or press the ▶ button to scroll up through the station frequencies.

The tuner will stop at the first strong signal it finds. To move to another station simply press the ◀ or ▶ button again.

SETTING PRESETS

Radio stations can be stored into the memory presets for easy access. You can store up to 15 presets for each band (i.e. 15 presets for the AM band plus 15 presets for the FM band).

Tune to the station you wish to store and hold down the Mode/Store button on the front of the unit. The display on the unit will flash the next available preset.

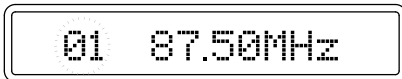

MODE/STORE



Press the Mode/Store button again to store the preset. The available preset will stop flashing to indicate that the station has been stored.

To change the preset number, simply press and hold the Mode/Store button to enter store mode then select any preset number you require with the ◀ and ▶ keys then press the Mode/Store button again to actually save the preset.

To recall a stored preset, simply press the number on the remote control that corresponds with the preset. Each of the preset buttons can select two presets. To select the second preset on the button, press the button again and this will toggle to the second preset.

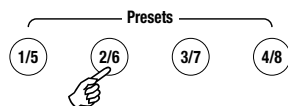

To load a stored preset from the front of the unit, simply press the number on the front of the unit or remote that corresponds with the preset. To access the second preset represented by the button, you must press and hold the button.

Note: You can only access stored presets 1-8 on the remote preset buttons. You can access stored presets 1-10 on the front panel preset buttons. To access all presets, set the mode to 'Preset' mode with the 'Mode' button on the remote control or 'Mode/Store' button on the front panel, and use the ◀ or ▶ buttons. This will allow access to the full 15 AM stored presets or 15 FM stored presets.

RESETTING TUNER PRESETS

To clear all stored presets for both AM and FM, press and hold both the 5/10 and Menu buttons at the same time. The unit will display 'Reset'. Restart the unit by powering off and on.

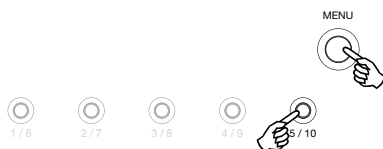

TUNER SETTINGS

It is possible to change the tuner region settings for this unit. This can be necessary if the unit has been moved to a different country.

Two settings are possible which set the correct de-emphasis and tuning steps for either North America or Europe/Rest of the world.

Note: Changing the tuner settings will clear all stored presets. When moving the unit to another region the Voltage Select switch must be set to the correct mains supply voltage by an authorized dealer.

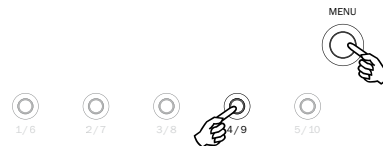

Press and hold both the 4/9 and Menu buttons at the same time. The display will show the software revision and followed by either a letter 'CU' which represents North America or a letter 'EU' which represents Europe/Rest of the world. Restart the unit by powering off and on.

Technical specifications

AXR100

Power output	100 watts (into 8Ω)
THD (unweighted)	<0.01% @ 1kHz, 80% of rated power <0.15% 20Hz - 20kHz, 80% of rated power
Frequency response (-1dB)	5Hz - 50kHz
S/N ratio (ref 1W)	>82dB (unweighted)
Input impedances	47k ohms
Power Amp damping factor	>50
Standby power consumption	<0.5W
Max. power consumption	550W
Bass/Treble controls	Shelving, ultimate boost/cut +/- 10dB @ 100Hz and 20kHz
Subwoofer output	200Hz 2nd order L+R Level follows volume setting
Digital inputs	PCM 16-24-bit S/P DIF Co-axial 32-192kHz TOSlink Optical 32-192kHz
Dimensions	110 x 430 x 340mm (4.3 x 16.9 x 13.4")
Weight	8.1kg (17.8lbs)
Bluetooth:	? 5.0 (Smart/BLE enabled) A2DP/AVRCP supporting SBC, AAC
TUNERS	
Bands	European AM (522-1629kHz) FM (87.5-108MHz)
	US AM (530-1710kHz) FM (87.5-108MHz)
Aerial inputs	FM 75 ohms, Coaxial. AM 300 ohms wire loop/single wire.
Signal to noise	60dB typical (FM)
Distortion	<0.4% @ 1kHz 50kHz deviation (FM mono) <0.6% @ 1kHz 50kHz deviation (FM stereo)

AXR85

Power output	85 watts (into 8Ω)
THD (unweighted)	<0.01% @ 1kHz, 80% of rated power <0.15% 20Hz - 20kHz, 80% of rated power
Frequency response (-1dB)	5Hz - 50kHz
S/N ratio (ref 1W)	>82dB (unweighted)
Input impedances	47k ohms
Power Amp damping factor	>50
Standby power consumption	<0.5W
Max. power consumption	500W
Bass/Treble controls	Shelving, ultimate boost/cut +/- 10dB @ 100Hz and 20kHz
Subwoofer output	200Hz 2nd order L+R Level follows volume setting
Dimensions	110 x 430 x 340mm (4.3 x 16.9 x 13.4")
Weight	8.1kg (17.8lbs)
Bluetooth:	? 5.0 (Smart/BLE enabled) A2DP/AVRCP supporting SBC, AAC
TUNERS	
Bands	European AM (522-1629kHz) FM (87.5-108MHz)
	US AM (530-1710kHz) FM (87.5-108MHz)
Aerial inputs	FM 75 ohms, Coaxial. AM 300 ohms wire loop/single wire.
Signal to noise	60dB typical (FM)
Distortion	<0.4% @ 1kHz 50kHz deviation (FM mono) <0.6% @ 1kHz 50kHz deviation (FM stereo)

Troubleshooting

THERE IS NO POWER

- Ensure the AC power cord is connected securely.
- Ensure the plug is fully inserted into the wall socket and is switched on.
- Check fuse in the mains plug or adaptor.
- Check the power is on at the front of the unit.

THERE IS NO SOUND

- Check the correct input is selected.
- Check that the speakers are connected correctly.
- If using the tuner, check aerial connections and an available station is selected.
- Check the unit is not in mute mode.
- Check the Speaker A/B configuration matches your speakers.

THE SOUND IS DISTORTED

- Check aerial connections and placements.
- Check speaker connections.
- There is a hum coming from the speaker
- Ensure that all cable connections are secure, particularly ground/shield connections. For turntables.

THERE IS UNWANTED BACKGROUND NOISE AND INTERFERENCE

- Move the unit away from other electrical equipment that is likely to cause interference.
- Re-orientate the aerial.
- Ensure that all cable connections are secure, particularly ground/shield connections for turntables.
- The remote handset will not function
- Check that the batteries have not expired.
- Ensure that nothing is blocking the remote sensor.

OVER TEMPERATURE PROTECTION

- The unit has an over temperature and shutdown protection. If the unit is continuously used for a long period and over heats, the unit will shut down. Leave the unit 'ON' for 10 minutes to cool down, then turn the unit off and on to continue listening.
- If the problem persists, then the unit is being over driven. Reduce the volume level, and ensure the unit is in an open ventilated area to resolve the problem.
- Use of two pairs of speakers which are less than 8 Ohms can cause overloading and is not recommended.

If you experience any trouble with your product, visit the help section on our webpage at <http://techsupport.cambridgeaudio.com>

Gallery Court, Hankey Place
London SE1 4BB
United Kingdom

Cambridge Audio is a brand of Audio Partnership Plc.
Registered in England No. 2953313

APxxxx/a

