



AM-200/AM-300 AirMedia® Presentation Systems

Product Manual
Crestron Electronics, Inc.



The product warranty can be found at www.crestron.com/legal/sales-terms-conditions-warranties.

The specific patents that cover Crestron products are listed at www.crestron.com/legal/patents.

Certain Crestron products contain open source software. For specific information, visit www.crestron.com/legal/open-source-software.

Crestron, the Crestron logo, AirMedia, .AV Framework, Crestron Connected, Crestron Fusion, Crestron Studio, Crestron Toolbox, Crestron XiO Cloud, DigitalMedia, DM, Pinpoint, and Zūm are either trademarks or registered trademarks of Crestron Electronics, Inc. in the United States and/or other countries. App Store, iPad, iPhone, iTunes, and Mac are either trademarks or registered trademarks of Apple, Inc. in the United States and/or other countries. Appspace is either a trademark or a registered trademark of Appspace Inc. in the United States and/or other countries. Android, Google Play, and YouTube are either trademarks or registered trademarks of Google, Inc. in the United States and/or other countries. iOS is either a trademark or registered trademark of Cisco Systems, Inc. in the United States and/or other countries. HDMI and the HDMI logo are either trademarks or registered trademarks of HDMI Licensing LLC in the United States and/or other countries. Microsoft, Active Directory, Microsoft Exchange Server, Outlook, PowerShell, and Windows are either trademarks or registered trademarks of Microsoft Corporation in the United States and/or other countries. Other trademarks, registered trademarks, and trade names may be used in this document to refer to either the entities claiming the marks and names or their products. Crestron disclaims any proprietary interest in the marks and names of others. Crestron is not responsible for errors in typography or photography.



This document was written by the Technical Publications department at Crestron.
©2019 Crestron Electronics, Inc.

Contents

- Introduction.....1**
- Requirements 3**
 - Administrator3
 - Operating Environment.....3
- Configuration..... 4**
 - Requirements.....4
 - Connect to the Device.....4
 - Log Out from the Device6
 - Configure the Device.....6
 - HDMI INPUT6
 - DM IN (AM-300 Only)7
 - HDMI OUTPUT8
 - NETWORK10
 - DEVICE15
 - APPSPACE.....24
 - AMPS26
 - AirMedia39
- Enterprise Deployment Options.....41**
 - Crestron XiO Cloud Service41
 - Claim a Single Device41
 - Claim Multiple Devices42
 - Crestron Deployment Tool for PowerShell® Software.....43
- Operation..... 44**
 - Connect a Source.....44
 - Touch Screen Operation.....44
 - System Controls.....45
 - Schedule a Meeting.....45
 - Present Content48
 - Keypad Operations.....50
 - System Power50
 - Volume.....50
 - Use AirMedia50
 - Establish a Connection51
 - Share Content53
- Appendix: AM-200 and AM-300 Systems..... 56**
 - Hookup Diagrams56
 - Supported and Tested DigitalMedia Transmitters (AM-300 Only).....57
 - Zūm™ Devices57
 - Supported Devices58

Add a Zūm Device to the Network	58
Monitor and Test Zūm Devices.....	58
Add a Touch Screen	59
IP Table Entry.....	59
Load a Touch Screen Project File.....	59

AM-200/AM-300: AirMedia Presentation Systems

Introduction

The AM-200 and AM-300 AirMedia® Presentation Systems provide room scheduling, and wired and wireless presenting capabilities for smaller conference rooms and huddle spaces. For more information on features, capabilities, and specifications on the AM-200 and AM-300, visit their respective websites at www.crestron.com.

Feature Comparison

FEATURE	AM-101	AM-200	AM-300
AirMedia 2.0 technology	x	✓	✓
AirMedia Device Support			
Windows® OS (All Versions)	✓	✓	✓
Mac®	✓	✓	✓
iPad®	✓	✓	✓
iPhone®	✓	✓	✓
iOS®	✓	✓	✓
Android™	✓	✓	✓
AirMedia Screen Mirroring Support			
Windows® OS (All Versions)	✓	✓	✓
Mac	✓	✓	✓
iPad	✓	✓	✓
iPhone	✓	✓	✓
iOS	✓	✓	✓
Android	✓	✓	✓
AirMedia Video + Audio Playback			
PC-Windows (All Versions)	✓	✓	✓
Mac	✓	✓	✓
iPad	✓	✓	✓
iPhone	✓	✓	✓
iOS	✓	✓	✓
Android	x	x	x
AirMedia Playback Features			
DRM Content Support (Netflix, etc)	x	x	x
Device Internet Connection Required for AirPlay Mirroring	x	✓	✓

FEATURE	AM-101	AM-200	AM-300
Security			
AES-128/TLS security	✗	✓	✓
802.1X	✗	✓	✓
Active Directory® Authentication	✗	✓	✓
Crestron® Control			
.AV Framework™ Platform	✓	✓	✓
Crestron XiO Cloud™ Service	✗	✓	✓
Crestron Studio® software	✓	N/A	N/A
SIMPL Windows	✓	✓	✓
SIMPL#	✓	✓	✓
Virtual Control	✓	✓	✓
Video Inputs			
HDMI® Input	✗	1	1
HDMI Resolution	✗	1080p	1080p
HDMI HDCP	✗	HDCP 1.4	HDCP 1.4
4K DigitalMedia™ Input	✗	✗	1
4K DigitalMedia Resolution	✗	✗	4k60 4:2:0
4K DigitalMedia HDCP	✗	✗	HDCP 2.2
Video Outputs			
HDMI Output	1	1	1 – 4K
HDMI Resolution	1080p	1080p	4K30
HDMI HDCP	HDCP 1.4	HDCP 1.4	HDCP 2.2
Touch Screen Support	Via programming only	External	External
Zūm™ Sensors and/or Buttons	✗	✓	✓
Other Interfaces			
COM/IR Support	✗	✓	✓
CEC	✗	✓	✓
Power Over Ethernet	✗	✓	✗
UC Features			
PinPoint™ UX	✗	✓	✓
Appspace® Application	✗	✓	✓
Crestron Airboard™ Whiteboard Capture System	✗	Coming Soon	Coming Soon
Quad view	✓	✗	✗
Remote View	✓	✗	✗
Moderator Mode	Windows & Android	✗	✗
Control System Interface	✓	✓	✓
AM-101 Compatibility Mode	N/A	✓	✗
YouTube® Push Mode Support	✗	✓	✓
Mounting	Freestanding Surface	Freestanding Surface Rack	Freestanding Surface Rack

FEATURE	AM-101	AM-200	AM-300
Dimensions (W x H x D)	6.15 in. x 1.10 in. x 2.39 in.	7.40 in. x 6.42 in. x 1.35 in.	9.29 in. x 7.93 in. x 1.36 in.

This product manual discusses the requirements, configuration instructions, and operating instructions for the AM-200 and AM-300. For information on installing the AM-200, refer to the AM-200 DO Guide (Doc. 8260). For information on installing the AM-300, refer to the AM-300 DO Guide (Doc. 8253) at www.crestron.com/manuals.

Requirements

Administrator

This document is written for use by a facility's Information Technology (IT) administrator. The IT administrator should have the following knowledge and skills:

- General Skills
 - IP Networking
 - Basic PC Operation and Administration
 - Calendaring system administration (for Exchange connectivity)
- Crestron-specific skills
 - Crestron Fusion® software (if applicable)
 - Crestron XiO Cloud service (if applicable)

Operating Environment

The AM-200 and AM-300 require the following to make the most of their capabilities.

- Zūm™ devices for control and occupancy sensing. The following devices can be used with an AM-200 or AM-300.
 - ZUMMESH-AVBRIDGE Wireless Control Integration Module
 - ZUMMESH-KP10AMBATT AirMedia keypad
 - ZUMMESH-PIR-OCCUPANCY-BATT Wireless Battery-Powered Occupancy Sensor

For details on configuring and using Zūm devices as part of an AM-200 or AM-300 system, refer to "Zūm™ Devices" on page 57.

- TSW touch screens for system control. The following touch screens can be used with an AM-200 or AM-300.
 - TSW-760 7 in. Touch Screen
 - TSW-1060 10 in. Touch Screen

For details on configuring and using a touch screen as part of an AM-200 or AM-300 system, refer to "Add a Touch Screen" on page 59.

- Crestron Fusion software allows the AM-200 or AM-300 to be monitored and managed through a central location. When used with an optional occupancy sensor, Crestron Fusion software also supports room scheduling, provides the ability to integrate with many third-party calendaring applications. Crestron Fusion software can also send pop-up messages that can display prominently on the connected display device in the event of an emergency or other important announcement.
- A Crestron XiO Cloud license allows the AM-200 or AM-300 to be monitored and managed through a central location using Crestron's XiO Cloud service.
- Microsoft® Exchange software allows the space's availability and details about the current scheduled meeting to appear on screen.

Configuration

Requirements

Configuration requires a computer with web browser software. The computer must be connected to the same network as the device to be configured.

Connect to the Device

To connect to the device, follow this procedure:

1. On the computer, open a web browser and navigate to the IP address or host name that is shown on the display device. The welcome screen is displayed.

Welcome Screen

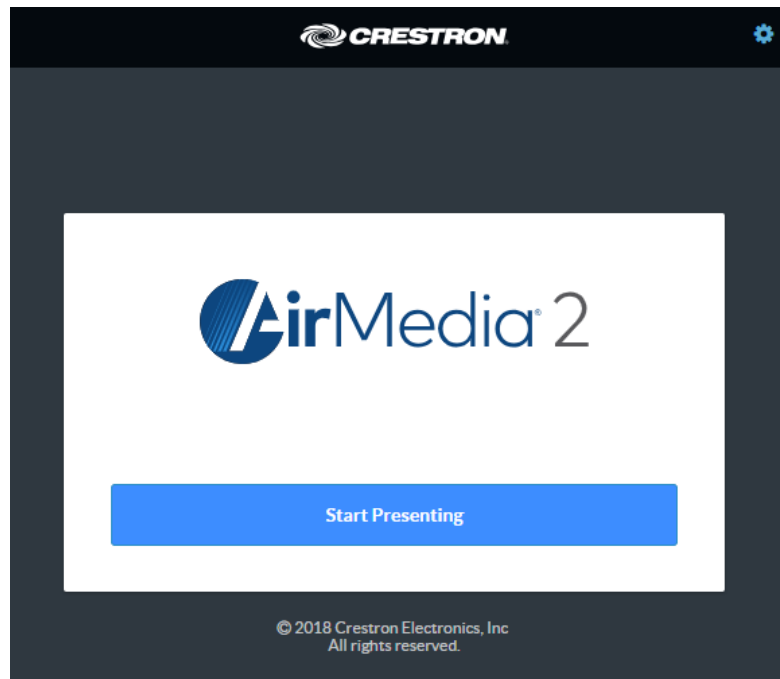

2. Click  to continue. A prompt for the user name and password is displayed.

NOTE: Prior to displaying the prompt for login credentials, the web browser may display a security warning message about the security certificate. It is safe to ignore this warning as long as the user verifies that the browser's address bar indicates the correct IP address or host name of the device.

3. Enter the default user name ("admin") and password ("admin"), and press **Enter** to continue. The device's **Status** screen is displayed.

Status Screen

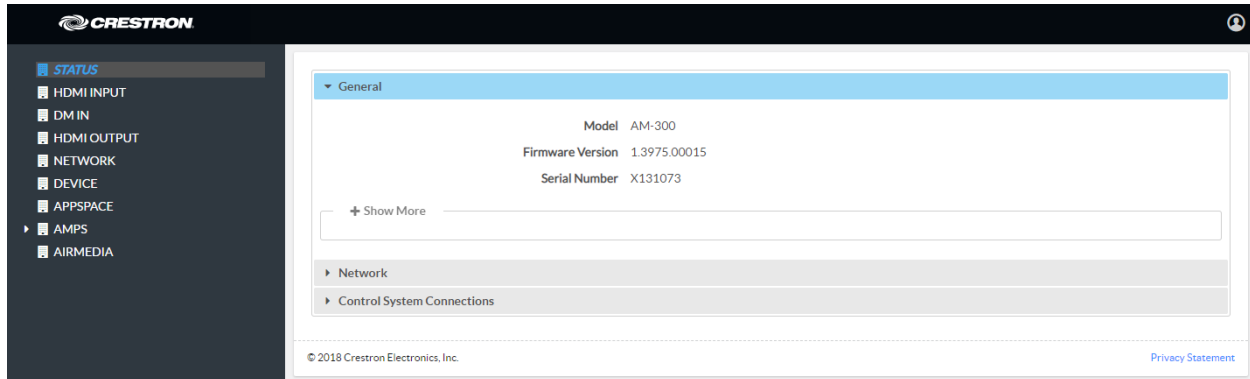

The **Status** screen displays information about the device and allows configuration of the device's operating parameters:

- **STATUS** contains general information about the device and network information.
 - Click **General** to view general information.
 - Click **Network** to view network information.
 - Click **Control System Connections** to view information about the device's connection to a control system.
- **HDMI INPUT** configures the HDMI input.
- **DM IN** configures the DM[®] input (AM-300 only).
- **HDMI OUTPUT** displays information about the HDMI output.
- **NETWORK** configures the device for operation in a network environment.
- **DEVICE** is used to set the connected display's standby time, upload firmware and projects, reboot the device, view the system log, configure the control system connection, and configure authentication management.
- **APPSPACE** is used to configure the device to work with the Appspace content management application for digital signage.
- **AMPS** configures the settings for Crestron Fusion integration, meeting functionality, room scheduling, and Zūm devices.
- **AIRMEDIA** configures the device's AirMedia presentation gateway functionality.

When displayed on any screen, click + **Show More** to view more details or click - **Show Less** to view fewer details.

Log Out from the Device

To log out from the device and return to the welcome screen, click .

Configure the Device

Configure the device as required for the installation.

HDMI INPUT

Click **HDMI INPUT** to configure the HDMI input. The screen displays selectors for HDCP support and EDID, as well as information about the input signal (if present).

HDMI INPUT Screen

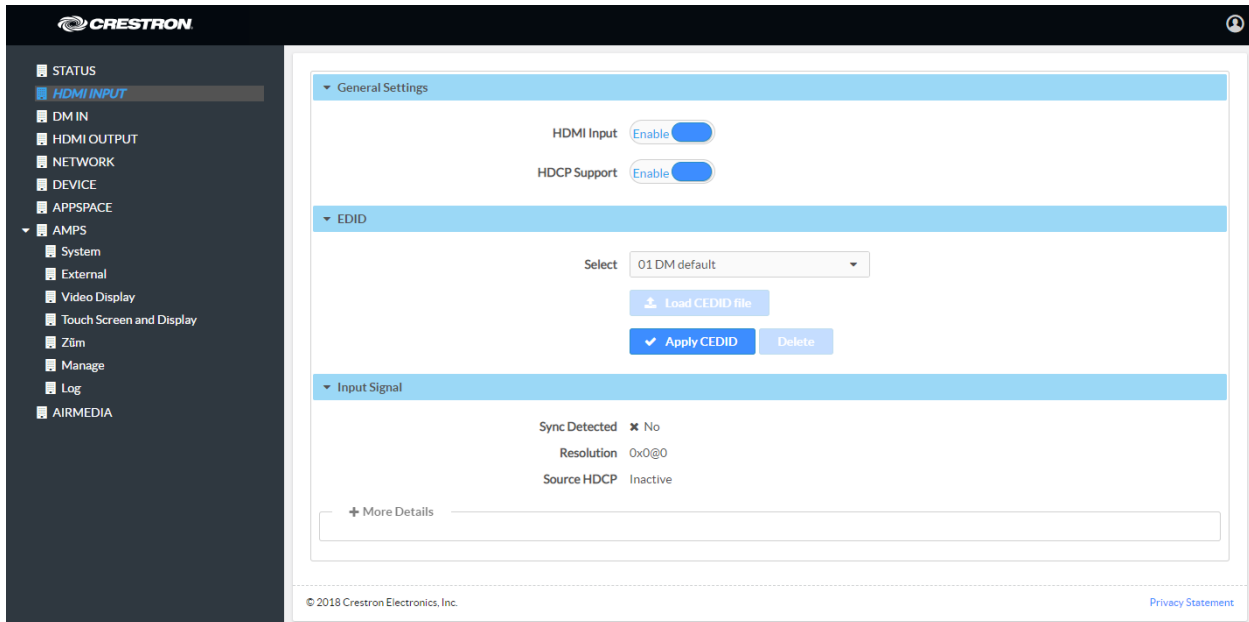

General Settings

Select whether the HDMI Input should be set to **Enable** or **Disable**. When set to **Enable**, sources connected to the HDMI input are received. When set to **Disable**, sources connected to the HDMI input are not received.

Select whether **HDCP Support** should be set to **Enable** or **Disable**. When HDCP support is enabled, source signals that require HDCP compliance are allowed to pass through to the display that is connected to the HDMI output. When HDCP support is disabled, source signals that require HDCP compliance are not allowed to pass through to the connected display.

NOTE: When **HDCP Support** is set to **Enable**, the connected display must be HDCP compliant as well.

EDID

EDID is a data structure provided by a digital display to describe its capabilities to a video source (i.e., graphics card or set-top box). It is what enables a modern personal computer to know what kinds of monitors are connected to it.

The EDID section of the **HDMI INPUT** screen specifies the EDID profile that is selected for use. Only source devices that use the selected EDID profile are allowed to send signals through the device.

To select an EDID profile to support, select one of the profiles to support from the drop-down list, and click **Apply CEDID**.

If a profile is not listed in the menu, a custom profile can be loaded onto the device. To load a custom CEDID profile, follow this procedure:

1. From the **Select** drop-down list, select **Custom**.
2. Click **Load CEDID** file.
3. Click **Browse** and navigate to the location of the custom CEDID file.
4. Select the file to use and click **Open**.
5. Click **Send EDID**.

Input Signal

Click **Input Signal** to view details about the input signal connected to the HDMI input port.

DM IN (AM-300 Only)

Click **DM IN** to configure the DM input. The screen displays a selector for EDID, as well as information about the input signal (if present).

DM IN Screen

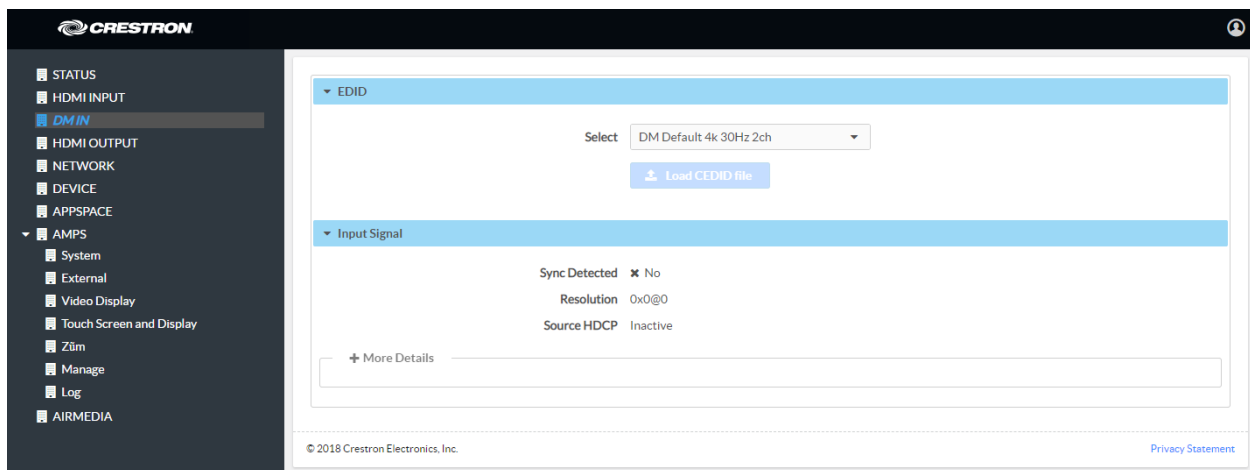

EDID

EDID is a data structure provided by a digital display to describe its capabilities to a video source (i.e., graphics card or set-top box). It is what enables a modern personal computer to know what kinds of monitors are connected to it.

The EDID section of the **DM INPUT** screen specifies the EDID profile that is selected for use. Only source devices that use the selected EDID profile are allowed to send signals through the device.

To select an EDID profile to support, select one of the profiles to support from the drop-down list, and click **Apply CEDID**.

If a profile is not listed in the menu, a custom profile can be loaded onto the device. To load a custom CEDID profile, follow this procedure:

1. From the **Select** drop-down list, select **Custom**.
2. Click **Load CEDID** file.
3. Click **Browse** and navigate to the location of the custom CEDID file.
4. Select the file to use and click **Open**.
5. Click **Send EDID**.

Input Signal

Click **Input Signal** to view details about the input signal connected to the DM input port.

HDMI OUTPUT

Click **HDMI OUTPUT** to change settings for the HDMI OUTPUT port and to display information about the connected display and output signal.

HDMI OUTPUT Screen

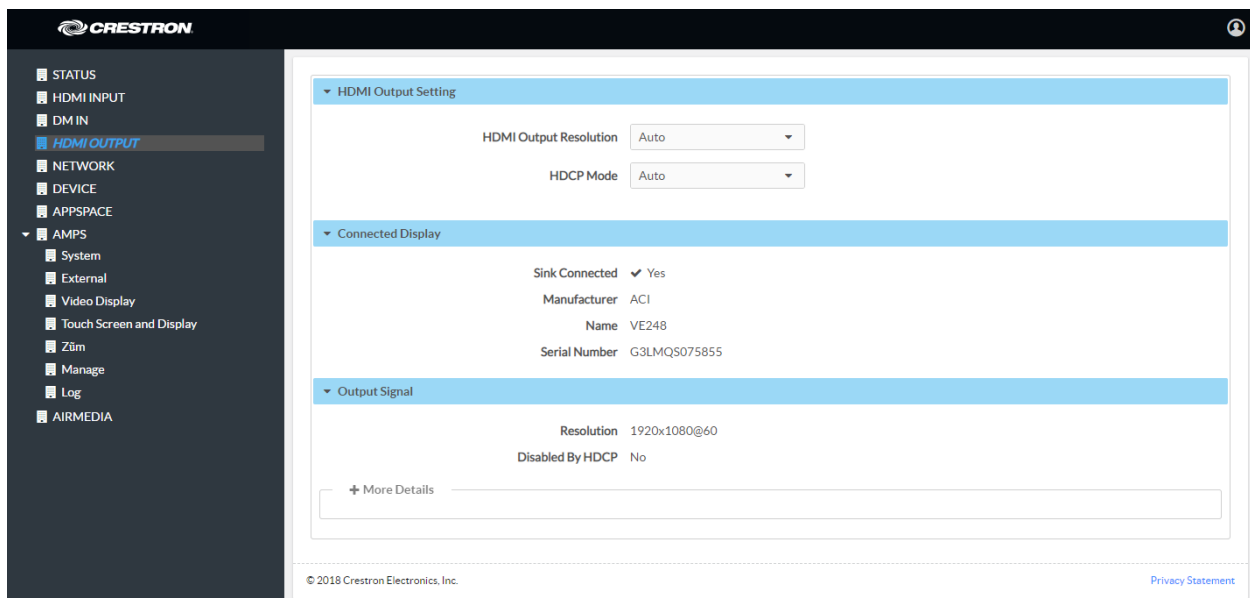

The screenshot displays the Crestron user interface for the HDMI OUTPUT screen. On the left is a dark sidebar with a navigation menu including STATUS, HDMI INPUT, DM IN, **HDMI OUTPUT** (highlighted), NETWORK, DEVICE, APPSPACE, and AMPS (expanded to show System, External, Video Display, Touch Screen and Display, Zim, Manage, Log, and AIRMEDIA). The main content area has a light blue header and three sections: 'HDMI Output Setting' with dropdowns for 'HDMI Output Resolution' (Auto) and 'HDCP Mode' (Auto); 'Connected Display' showing 'Sink Connected' (checked Yes), 'Manufacturer' (ACI), 'Name' (VE248), and 'Serial Number' (G3LMQ5075855); and 'Output Signal' showing 'Resolution' (1920x1080@60) and 'Disabled By HDCP' (No). A '+ More Details' button is at the bottom of the Output Signal section. The footer contains '© 2018 Crestron Electronics, Inc.' and a 'Privacy Statement' link.

HDMI Output Setting

- Select the output resolution from the **HDMI Output Resolution** drop-down list.
- Select the HDCP mode from the **HDCP Mode** drop-down list.

When **HDCP Mode** is set to **Auto**, the device will always attempt to use HDCP compliance on the output device if support is detected on the display device.

When **HDCP Mode** is set to **Always** (AM-300 only), the device will always attempt to use HDCP compliance on the output even if downstream devices do not support HDCP.

When **HDCP Mode** is set to **Never**, the device will never attempt to use HDCP compliance with downstream, regardless of support.

Connected Display

Click **Connected Display** to view details about the device connected to the HDMI output port.

Output Signal

Click **Output Signal** to view details about the signal sent to the HDMI output port.

NETWORK

Click **NETWORK** to configure the device for operating in a network environment. The screen displays controls for configuring the network settings and 802.1x authentication.

Network Setting

To configure the network settings, follow this procedure:

NETWORK Screen - Network Setting

The screenshot shows the Crestron Network Setting interface. The sidebar on the left lists various system settings, with 'NETWORK' highlighted. The main content area is titled 'Network Setting' and includes the following fields and controls:

- Host Name:** AM-300-TECHPUBS
- Domain Name:** CRESTRON.CRESTRON
- SSH:** Enabled (toggle switch)
- Primary Static DNS:** _____
- Secondary Static DNS:** _____
- Adapter 1:**
 - DHCP:** Enabled (toggle switch)
 - IP Address:** 172.30.16.101
 - Subnet Mask:** 255.255.255.0
 - Default Gateway:** 172.30.16.1

At the bottom of the main area, there is a section for '802.1x Configuration'. The footer contains the copyright notice '© 2018 Crestron Electronics, Inc.' and a link to the 'Privacy Statement'.

1. Enter a host name (15 characters or less) in the **Host Name** field and a domain name (optional) in the **Domain Name** field.

NOTE: Use a host name and domain name as an alternative to IP addressing when connecting client computers to the device.

2. Select whether Secure Shell protocol (**SSH**) should be **Enabled** or **Disabled**.
3. The network adapter can be set to have the DHCP server automatically provide the IP address, subnet mask, default gateway, and DNS settings or to enable entering these settings manually. Choose one of the following options.
 - Set **DHCP** to **Enabled** to use a DHCP server to automatically provide the IP address, subnet mask, default gateway, and DNS server.
 - Set **DHCP** to **Disabled** to manually enter the Ethernet parameters. When set to **Off**, the IP address, subnet mask, default gateway, and DNS servers must be manually entered.
4. Click **Save Changes** to apply any changes. Click **Revert** to revert back to the previously used settings.

802.1x Configuration

Some networks require devices to use 802.1x port-based network access control for access to the network.

NETWORK Screen - 802.1x Configuration

The screenshot displays the Crestron NETWORK configuration interface. On the left is a dark sidebar with a menu including STATUS, HDMI INPUT, DM IN, HDMI OUTPUT, NETWORK (highlighted), DEVICE, APPSPACE, AMPS, System, External, Video Display, Touch Screen and Display, Züm, Manage, Log, and AIRMEDIA. The main content area is titled 'Network Setting' and '802.1x Configuration'. It features a toggle for 'IEEE 802.1x Authentication' set to 'Enabled'. Below this is a dropdown for 'Authentication Method' set to 'EAP MSCHAP V2- password'. There are input fields for 'Domain', 'Username' (containing 'tpubs'), and 'Password' (masked with dots). Another toggle for 'Enable Authentication Server Validation' is also set to 'Enabled'. A section titled 'Select Trusted Certificate Authority(s)' contains a search bar and a list of CA options with checkboxes, including AAA Certificate Services, AC RAIZ FNMT-RCM, AC Raiz Certicámara S.A., ACCVRAIZ1, ACEDICOM Root, Actalis Authentication Root CA, AddTrust External CA Root, AffirmTrust Commercial, AffirmTrust Networking, AffirmTrust Premium ECC, AffirmTrust Premium, Amazon Root CA 1, Amazon Root CA 2, Amazon Root CA 3, Amazon Root CA 4, and America Online Root Certification Authority 1. A 'Manage Certificates' button is located at the bottom of this list. The footer shows '© 2018 Crestron Electronics, Inc.' and a 'Privacy Statement' link.

To use 802.1x, set **IEEE 802.1x Authentication** to **Enabled** and select the desired method of authentication.

Certificate Authentication

1. In the Authentication Method field, select **EAP-TLS Certificate**.
2. Enter the domain name of the authentication server.

3. Upload a machine certificate.
 - a. Click **Manage Certificates** to manage certificates for 802.1x authentication. A list of certificates is displayed.

Manage Certificates Dialog Box

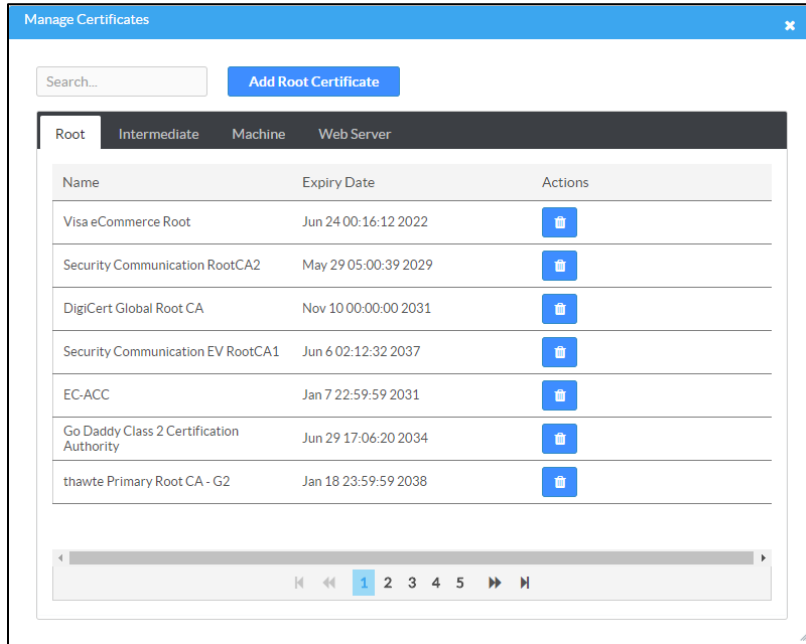

- b. Click the **Machine** tab. The current machine certificate is displayed.
- c. Click  to delete the certificate from the list of certificates.
- d. Click **Add Machine Certificate**. The Add Certificate dialog box is displayed.

Add Certificate Dialog Box

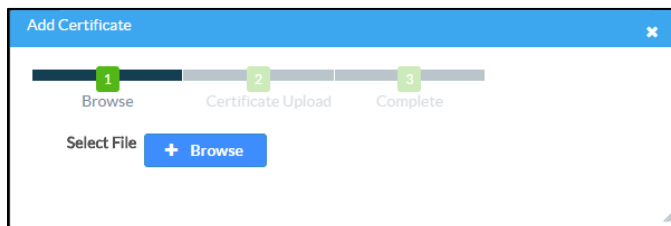

- e. Click **Browse**, select the certificate file, and click **Open**.
- f. When prompted, enter the password used to encrypt the file.
- g. Click **Load** to upload the certificate to the device. A message confirming the upload is displayed.
- h. Click **OK** to close the **Add Certificate** dialog box.

4. If authentication server validation is not used, set **Enable Server Validation** to **Disabled** and continue to step 6. Otherwise, set **Enable Server Validation** to **Enabled** and select the trusted certificate authorities to use.
 - To select all of the authorities, click the check box next to the search box. To unselect all of the authorities, click the check box again.
 - To search for a specific authority, start typing the name of the authority in the search box and check the box next to the desired authority.
5. Click **Manage Certificates** to manage certificates for 802.1x authentication. A list of certificates is displayed.

Manage Certificates Dialog Box

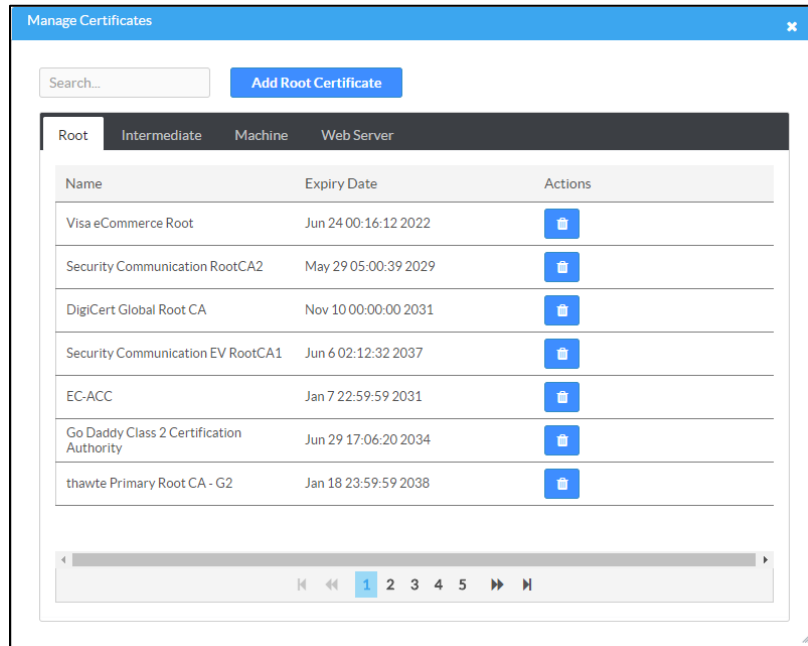

- a. Click  to delete a certificate from the list of certificates.
- b. Click **Add Root Certificate**. The **Add Certificate** dialog box is displayed.

Add Certificate Dialog Box

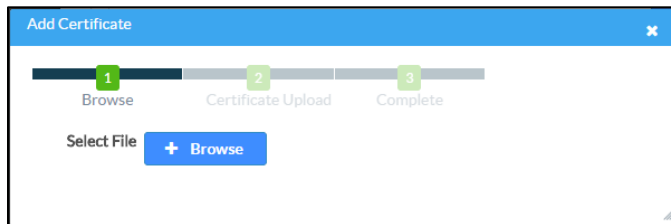

- c. Click **Browse**, select the certificate file, and click **Open**.
- d. Click **Load** to upload the certificate to the device. A message confirming the upload is displayed.

- e. Click **OK** to close the **Add Certificate** dialog box.
6. Click **Save Changes** when done or **Revert** to return to the previous setting.

Password Authentication

1. In the Authentication Method field, select **EAP-MSCHAP V2-password**.
2. Enter the domain name of the authentication server, the user name, and the password in their respective fields.
3. Set **Enable Server Validation** to **Enabled** and select the trusted certificate authorities to use.
 - To select all of the authorities, click the check box next to the search box. To unselect all of the authorities, click the check box again.
 - To search for a specific authority, start typing the name of the authority in the search box and check the boxes next to the desired authorities.
4. To load a custom certificate, click **Manage Certificates** and follow this procedure:
 - a. Click the **Root** tab to manage certificates for 802.1x authentication.

Manage Certificates: Root Tab

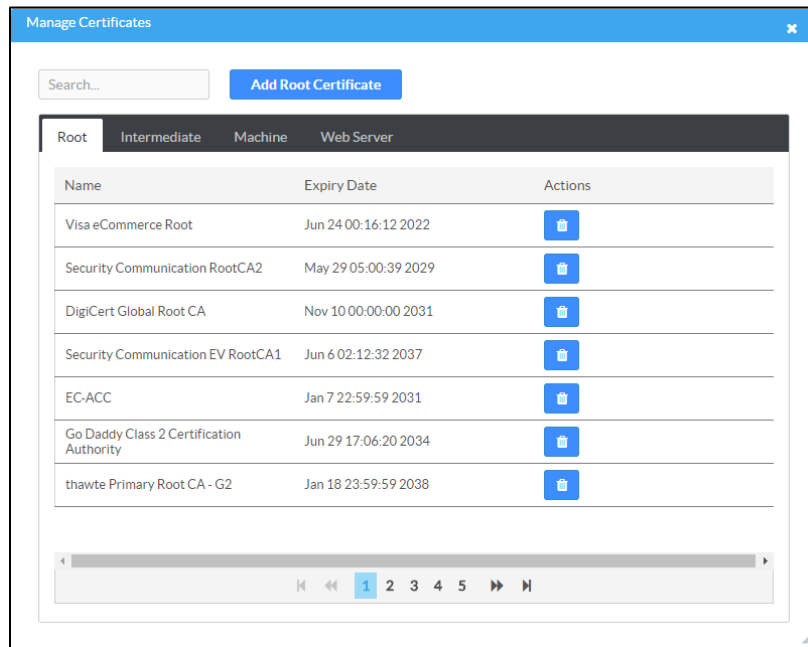

- b. Click **Add Root Certificate**. The **Add Certificate** dialog box is displayed.

Add Certificate Dialog Box



- c. Click **Browse**, select the certificate file, and click **Open**.
 - d. Click **Load** to upload the certificate to the device. A message confirming the upload is displayed.
 - e. Click **OK** to close the **Add Certificate** dialog box.
5. Click **Save Changes** when done or **Revert** to return to the previous setting.

DEVICE

Click **DEVICE** to manage the device, enable automatic updates, identify the device to a control system, configure date and time, and configure authentication management.

DEVICE Screen –Device Management

Device Management

Firmware

To upload device firmware, follow this procedure:

1. Click **Firmware Upgrade**.
2. Click **Browse** and navigate to the location of the firmware file.
3. Select the file to use and click **Open**.
4. Click **Load** to load the firmware.

Maintenance

Click **Restore** to restore the factory settings. Click **Reboot** to reboot the device.

Device Logs

Click **Download Logs** to download the device's system logs to the PC.

Cloud Settings

The **Cloud Settings** section controls the device's connection to the Crestron XiO Cloud service. By default, the **Cloud Configuration Service Connection** is set to **Enabled**. To disable the connection, set **Cloud Configuration Service Connection** to **Disabled**. For more information, refer to "Crestron XiO Cloud Service" on page 41.

Auto Update

DEVICE Screen - Auto Update

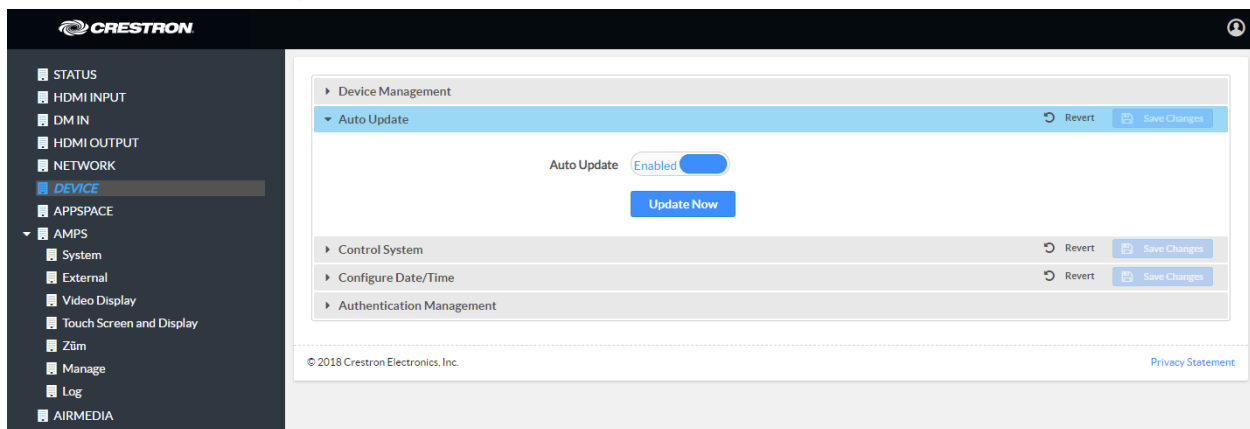

The device can automatically check for firmware updates and update the device as needed.

To allow auto updating, set **Auto Update** to **Enabled**. To turn off auto updating, set **Auto Update** to **Disabled**.

To check for available updates, click **Update Now**.

Control System

DEVICE Screen - Control System (AM-200 Shown)

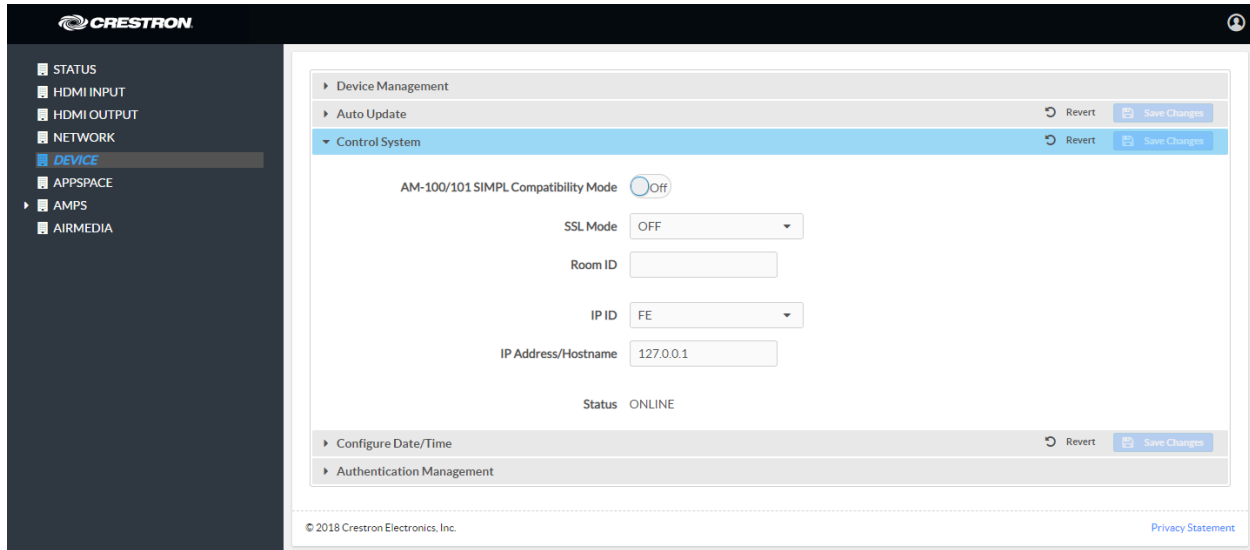

The device can be controlled by a Crestron control system or virtual control system's SIMPL or SIMPL# program.

AM-100/AM-101 Compatibility

An AM-200 can be used as a direct replacement for an AM-100 or AM-101 AirMedia Presentation Gateway in a SIMPL Windows program without any reprogramming. To use the AM-200 as a replacement for an AM-100 or AM-101, set **AM-100/101 SIMPL Compatibility Mode** to **On**. Otherwise set the switch to **Off**.

SSL

The device can use SSL encryption for communication with the control system. SSL can be used with or without a CA certificate.

Select an SSL mode from the **SSL Mode** drop-down list.

- **OFF:** SSL is not used for communication between the device and the control system
- **Encrypt:** SSL is used for communication between the device and the control system. User-level authentication is optional. If using authentication, enter the following information:
 - **Control System Username:** The login name for the control system.
 - **Control System Password:** The password used to log in to the control system.
 - **Confirm Password:** Confirm the password used to log in to the control system.

- **Encrypt and Validate:** SSL is used for communication between the device and the control system. The control system will be validated against a root CA certificate. User-level authentication is optional. If using authentication, enter the following information:
 - **Control System Username:** The login name for the control system.
 - **Control System Password:** The password used to log in to the control system.
 - **Confirm Password:** Confirm the password used to log in to the control system.

If using the **Encrypt and Validate** setting, a root certificate must be placed in the /SYS directory on the device. Use FTP software to place the root certificate in the /SYS directory on the device.

NOTE: The root certificate file name must have a *.PEM* extension. i.e. *rootCA_cert.pem*.

Control System Connection

To specify the control system connection:

1. Enter a descriptive name for the device in the **Room ID** field.
2. Select the IP ID of the device from the **IP ID** drop-down list.

NOTE: The IP ID must match the IP ID defined in the SIMPL Windows or SIMPL# program.

3. Enter the control system's IP address or host name in the **IP Address/Hostname** field.
4. Click **Save Changes** to apply any changes. Click **Revert** to revert back to the previously used settings.

The **Status** field indicates a connection to the control system program if the device is listed in the control system's IP table.

Configure the Date and Time

DEVICE Screen - Configure Date/Time

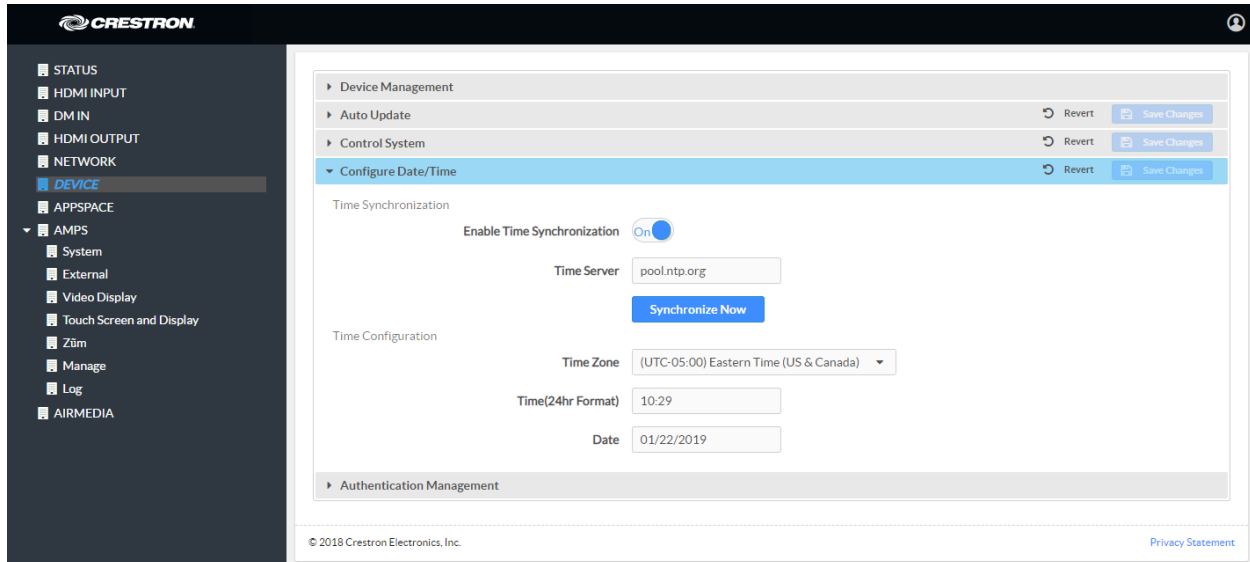

The device's internal clock can be synchronized with a time server or set manually.

NOTE: The time is automatically set when connected to Crestron Fusion. Any settings made here do not apply.

Use Time Server Synchronization

1. Set **Enable Time Synchronization** to **On**.
2. Enter the time server's IP address or host name in the **Time Server** field.
3. Click **Synchronize Now** to sync the device with the specified time server.

Set the Time Manually

1. Set **Enable Time Synchronization** to **Off**.
2. Select the time zone from the **Time Zones** list.
3. Enter the time (in 24 hour format) in the **Time(24hr Format)** field.
4. Click on the **Date** field, and then click to select a date from the calendar that is displayed.
5. Click **Save Changes** to apply any changes. Click **Revert** to revert back to the previously used settings.

Authentication Management

DEVICE Screen - Authentication Management

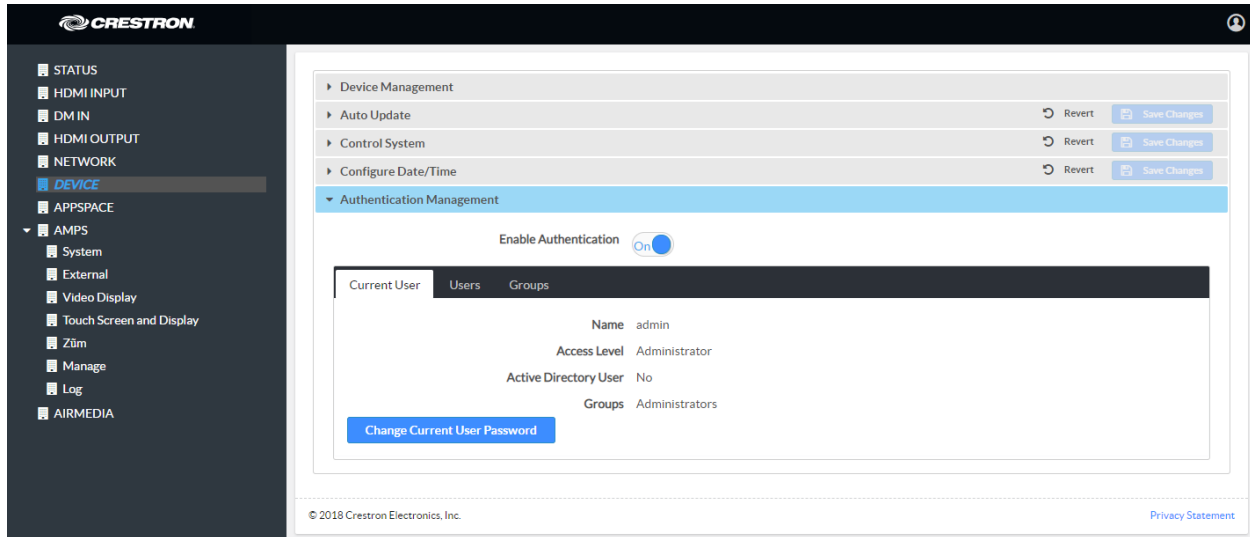

This section is used to set the password for the current user, and to manage authorized users and user groups. By default, **Enable Authentication** is set to **On**.

Current User

Click the **Current User** tab to view information about the current user and change the password.

1. Click **Change Current User Password** to change the current user's password.
2. Enter the new password in the **Password** field.
3. Confirm the new password in the **Confirm Password** field.
4. Click **OK** to set the new password or click **Cancel** to cancel.

Users

Click the **Users** tab to manage and create authorized users. A list of authorized users is displayed.

DEVICE Screen - Authentication Management: Users Tab

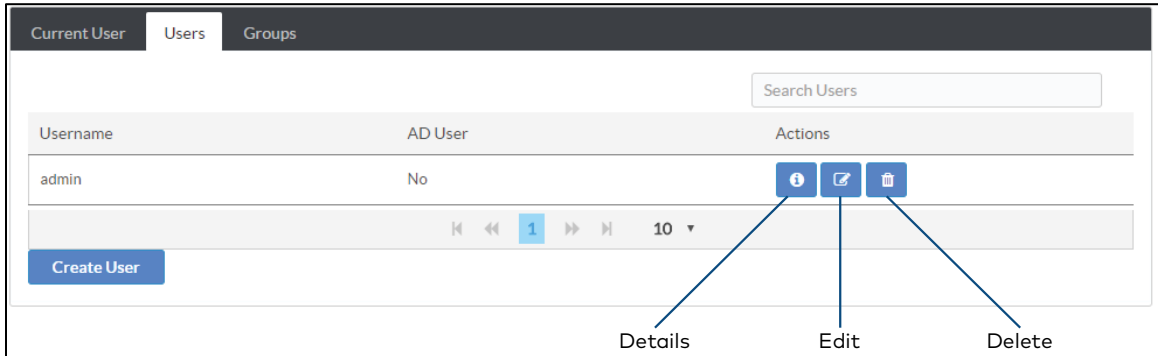

Search for a User

To search for a user, enter the name in the **Search Users** box, and press **Enter**.

View User Details

To view details about a user, click . Click **OK** when done.

Update a User

To update a user's information, click .

Update User Dialog Box

1. Enter the user password in the **Password** field.
2. Confirm the password in the **Confirm Password** field.
3. Select the user's group memberships from the **Groups** drop-down list.
4. Select whether the user is a member of the Active Directory® group with **the Active Directory User** switch.
5. Click **OK** to save the changes or click **Cancel** to cancel.

Delete a User

To delete a user from the list of authorized users, click . Click **Yes** to confirm or **No** to cancel.

Create a User

To create a user:

1. Click **Create User**. The **Create User** dialog box is displayed.

Create User Dialog Box

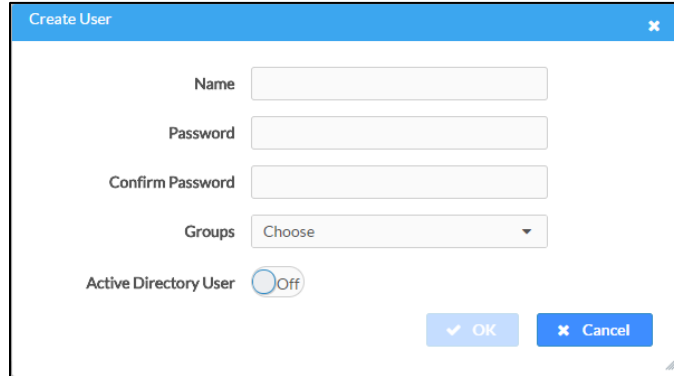

The screenshot shows a 'Create User' dialog box with the following fields and controls:

- Name**: Text input field.
- Password**: Text input field.
- Confirm Password**: Text input field.
- Groups**: Dropdown menu with 'Choose' selected.
- Active Directory User**: Toggle switch currently set to 'Off'.
- OK** and **Cancel** buttons at the bottom right.

2. Enter the user name in the **Name** field.
3. Enter the user password in the **Password** field.
4. Confirm the password in the **Confirm Password** field.
5. Select the user's group memberships from the **Groups** drop-down list.
6. Select whether the user is a member of the Active Directory group with the **Active Directory User** switch.
7. Click **OK** to save the user or click **Cancel** to cancel.

User Groups

Click the **Groups** tab to configure user groups. A list of user groups is displayed.

DEVICE Screen - Authentication Management: Groups Tab

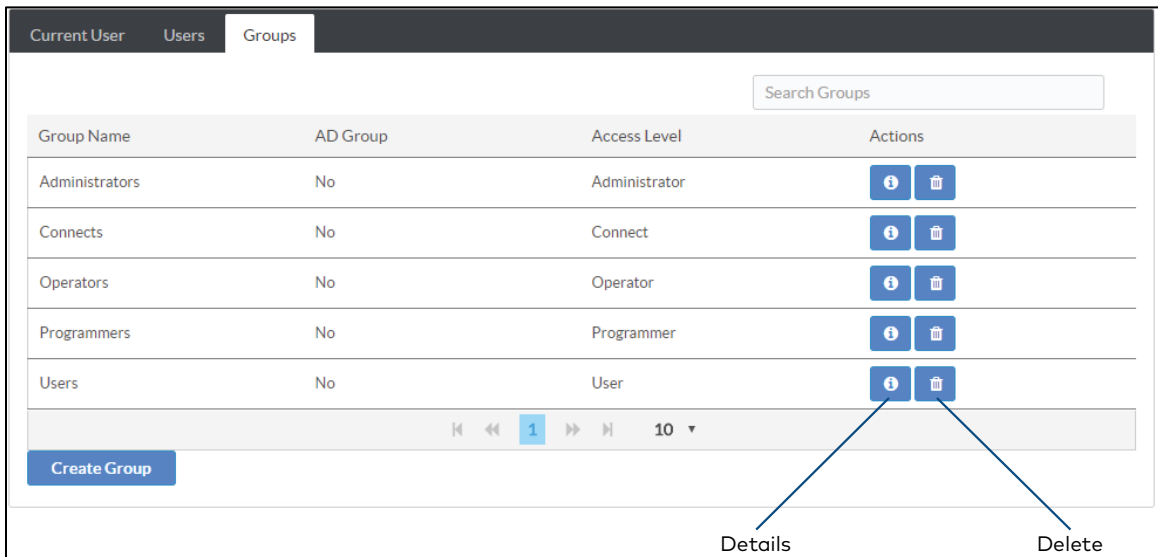

Search for a Group

To search for a group, enter the name in the **Search Groups** box, and press **Enter**.

View Group Details

To view details about a group, click . Click **OK** when done.

Delete a Group

To delete a group from the list of groups, click . Click **Yes** to confirm or **No** to cancel.

Create a User Group

To create a user group:

1. Click **Create Group**. The **Create Group** dialog box is displayed.

Create Group Dialog Box

The 'Create Group' dialog box has a title bar with a close button. It contains three fields: 'Name' (text input), 'Access Level' (dropdown menu with 'Administrator' selected), and 'Active Directory Group' (radio button with 'Off' selected). At the bottom, there are 'OK' and 'Cancel' buttons.

2. Enter the group name in the **Name** field.

3. Select the group's access level from the **Access Level** drop-down list.
 - Administrator grants full access to the system settings and device functions.
 - Connect grants access to the device functions.
 - Operator grants read access to the system settings and full access to the device functions.
 - Programmer grants access to program/project specific settings/ReadOnly to the rest, read/write access to the file system, no access to the setup project.
 - User grants access to the device functions.
4. Set the **Active Directory Group** setting to **Off** or **On**.
5. Click **OK** to save the group or click **Cancel** to cancel.

APPSPACE

The AM-200 and AM-300 can display content from an Appspace account when the device is not in use (determined by the built-in occupancy sensor).

NOTES:

- An active Appspace account is required.
- Appspace video service is not supported.
- To use Appspace when the device is in Standby, the Power Settings must be set to "**Occupancy Based With Signage**" as described in "Power Settings" on page 27.

Click **APPSPACE** to configure the device's operation with the Appspace platform.

APPSPACE Screen

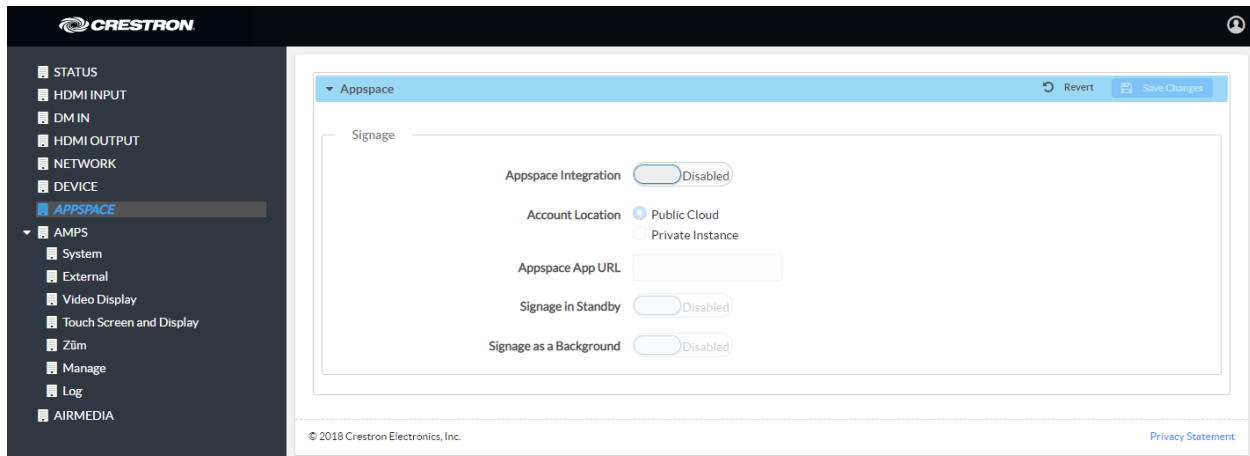

To configure the device for use with Appspace:

1. Set **Appspace Integration** to **Enabled** to enable Appspace when the device goes to sleep based on occupancy (Standby). When enabled, the connected display will show Appspace content.

NOTE: To use Appspace when the device is in Standby, the Power Settings must be set to "**Occupancy Based With Signage**" as described in "Power Settings" on page 27.

2. Choose the **Account Location**.
 - **Public Cloud:** Select this option to use the Appspace public web app.
 - **Private Instance:** Select this option to use a privately hosted instance of the Appspace web app.
3. Enter the **Appspace App URL**. This is the URL where a privately hosted instance of the Appspace web app can be found. Leave blank if the **Public Cloud** account location is selected.
4. Set **Signage in Standby** to **Enabled** to display Appspace content when the CCS-UC-1 goes to sleep based on occupancy. Set to **Disabled** to turn off the feature.
5. Set **Signage as a Background** to **Enabled** to display Appspace content on the connected display behind the calendar, date/time, system name, connection info and branding portions of the display.

NOTE: When set to **Enabled**, the **Enable Custom Backgrounds** and **Interval Between Backgrounds** options on the Room Schedule screen (described in "Display Customization" on page 34) are disabled.

6. Click **Save Changes** when done or **Revert** to return to the previous setting.

AMPS

Click **AMPS** to configure the device's .AV Framework™ platform functionality. Click ▶ to display links for configuring system settings, controlling Crestron Fusion software operation, configuring the connected video display, configuring front panel operation, adding and monitoring Zūm devices, managing the system's configuration, and viewing activity logs.

System

The **System** screen specifies the room name, the local language setting, the time format, the date format, and manages the power settings.

AMPS Screen - System

The screenshot displays the AMPS System configuration interface. On the left is a dark sidebar with a navigation menu. The main content area is white and features a green status bar at the top that reads "The system is currently online." Below this, the "System" section is expanded, showing "System Settings" and "Power Settings".

System Settings:

- Room Name: AVF 34333
- Language: English (English)
- Time Format: 12 hour
- Date Format: January 15, 2017

Power Settings:

- Standby: Always On

Day Of Week	Enabled	Display On	Display Off
Sunday	Enable <input checked="" type="checkbox"/>	12:00 AM	11:59 PM
Monday	Enable <input checked="" type="checkbox"/>	12:00 AM	11:59 PM
Tuesday	Enable <input checked="" type="checkbox"/>	12:00 AM	11:59 PM
Wednesday	Enable <input checked="" type="checkbox"/>	12:00 AM	11:59 PM
Thursday	Enable <input checked="" type="checkbox"/>	12:00 AM	11:59 PM
Friday	Enable <input checked="" type="checkbox"/>	12:00 AM	11:59 PM
Saturday	Enable <input checked="" type="checkbox"/>	12:00 AM	11:59 PM

System Settings

To configure the system settings, follow this procedure:

1. Click **System** to display the **AVF (System)** screen.
2. In the **Room Name** field, enter the name of the room where the device is installed.
3. Select the local language from the **Language** drop-down list.
4. Select the time format from the **Time Format** drop-down list (**12 hour** or **24 hour**).
5. Select the date format from the **Date Format** drop-down list.

Power Settings

Configure power settings to manage the system's power usage. To configure the power settings, follow this procedure:

1. Select one of the following modes from the **Standby** drop-down list.
 - **Always On** sets the following:

NOTE: **Always On** is the default setting.

- The connected display will be on during business hours (defined in step 2).
 - The touch screen will always be on.
 - Crestron Fusion power events will be ignored.
 - During business hours, "Occupancy Vacant" events will be ignored.
 - During business hours "Occupancy Occupied" events will turn on room if the room is off.
 - Outside of business hours, Occupancy events can turn the room on and off.
 - Hard button power events will be allowed.
 - HDMI sync and video route will turn the room on outside of business hours.
 - Panel hard button will be active to turn off the connected display and the touch screen will be blank.
- **Based on Occupancy** sets the following:
 - The connected occupancy sensor will be used to determine when the room is occupied or vacant.
 - When the room is occupied the system will be on.
 - When the room is vacant the system will be off.

- If the connected display is configured as a controlled display, it will be on when the room is occupied and off when the room is vacant.
 - The touch screen will be on when the room is occupied and off when the room is vacant.
 - Crestron Fusion power events will not be ignored.
 - A detected video sync signal will turn on the room.
 - Connecting to the device by an AirMedia connection will not turn on the room.
- **Occupancy Based With Signage** sets the following:
- The occupancy sensor will be used to determine when the room is occupied or vacant.
 - When the room is occupied the system will be on.
 - When the room is vacant, the system will be operating in standby mode during defined business hours and off outside of business hours (defined in step 2).
 - The connected display will be on when the system is in standby mode and off when the system is off.
 - The touch screen will be on when the room is occupied and off when the room is vacant.
 - When in the standby mode, digital signage that is configured to run during standby mode will be displayed.
 - Crestron Fusion power events will not be ignored.
 - Connecting an active HDMI input source will turn on the room.
 - Connecting to the device by an AirMedia connection will not turn on the room.

NOTE: The **Occupancy Based With Signage** setting must be selected if Appspace is to be used.

2. For each day of the week, define business hours:
 - **Enabled** sets whether the day is part of the business hours schedule. Set the switch to **Enabled** to have the day included in the business hours schedule. Set the switch to **Disabled** to remove the day from the business hours schedule.
 - **Display on** sets the time the connected display will turn on. To set the on time, click the hour, then click the exact time.
 - **Display Off** sets the time the connected display will turn off. To set the off time, click the hour, then click the exact time.
3. Click **Save** to save the settings.

The following table shows each operation's ability for each **Standby** setting.

Operation versus Standby Setting

OPERATION	STANDBY SETTING		
	ALWAYS ON	OCCUPANCY BASED	OCCUPANCY BASED WITH SIGNAGE
Always On	✓	✗	✗
Standby Off	✗	✗	✓
Allow Crestron Fusion Power On	✗	✓	✓
Allow Crestron Fusion Power Off	✗	✓	✓
Allow Video Sync Power On	✓	✓	✓
Allow Video Route Power On	✓	✓	✓
Allow Hard Button Power Off	✓	✓	✓
Allow Hard Button Power On	✓	✓	✓
Allow Fixed Schedule Power Control	✓	✗	✓
Allow Occupancy Power Control	✓*	✓	✓
Allow Display Back Light Control	✓	✓	✓
Allow Display Touch Activity Power On	✓	✓	✓

* After business hours.

External

The **External** screen displays the settings for operating with Crestron Fusion.

AMPS Screen - External

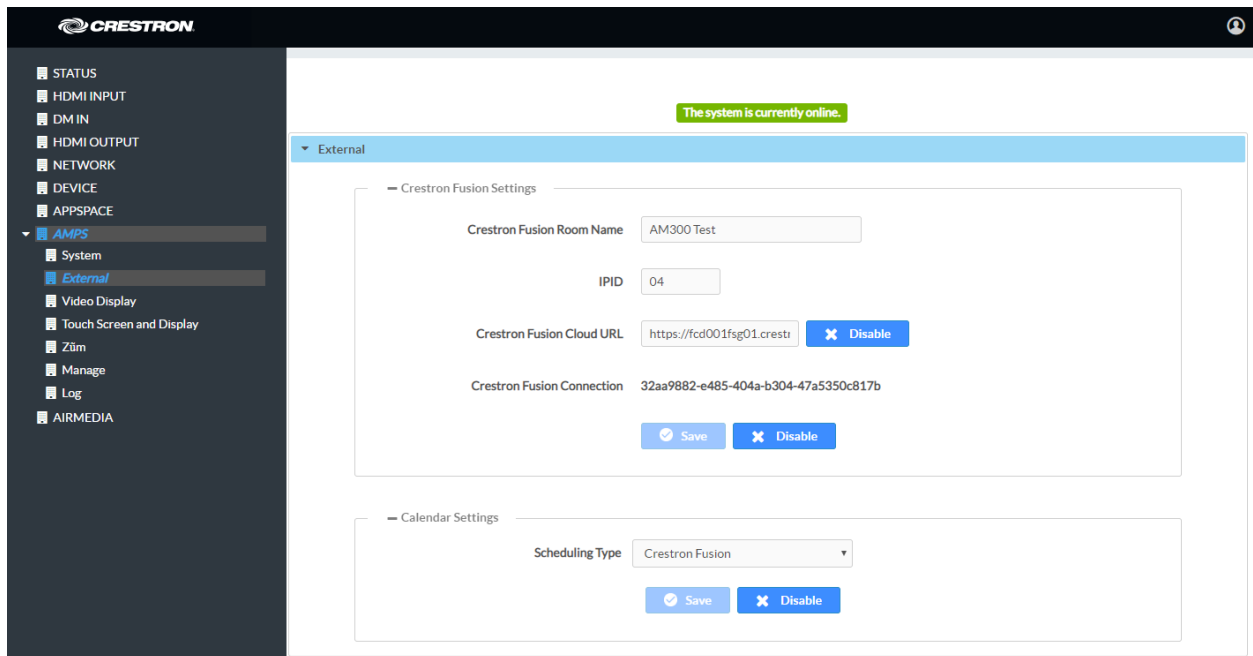

Crestron Fusion Settings

To configure the Crestron Fusion settings, follow this procedure:

1. In the **Crestron Fusion Room Name** field, enter the name to be used by the Crestron Fusion server.

2. In the **IPID** field, enter the IP ID number to be used by the Crestron Fusion server.
3. In the **Crestron Fusion Cloud URL** field, click **Enable** to allow autodiscovery by the Crestron Fusion server.
4. Click **Save** to save the settings or click **Disable** to disable the settings.

Upon completion, the device should be brought into Crestron Fusion software as a processor. For details, refer to the Crestron Fusion help file.

Calendar Settings

To configure the calendar settings, follow this procedure:

1. Select the scheduling type from the drop-down list.
 - Select **SchedulingType Fusion** to use Crestron Fusion for calendar functions.
 - Select **SchedulingType Exchange** to use Microsoft Exchange Server® software for calendar functions.
 - a. Enter the URL of the Exchange server in the **Exchange EWS URL** field.
 - b. Enter the domain name used by the Exchange server in the **Domain** field.
 - c. Enter the name of the conference room in the **Username** field.
 - d. Enter the password of the conference room in the **Password** field.
 - e. Enter the Calendar email address in the **Calendar email address** field.

NOTE: The Calendar email address is required only for accounts using Impersonation.

- f. (Optional) Check the **Outlook Use Certificate** box to use an Outlook® certificate. Click **Upload** and follow the instructions to upload a certificate.

For more information, refer to Answer IDs 5829 and 5830 in the Online Help on the Crestron website (www.crestron.com/onlinehelp).

2. Click **Save** to save the settings or click **Disable** to disable the settings.

Video Display

The **Video Display** screen configures the device for operation with the connected display. Support for CEC, Crestron Connected®, IP, serial, and infrared profiles are built-in.

AMPS Screen - Video Display

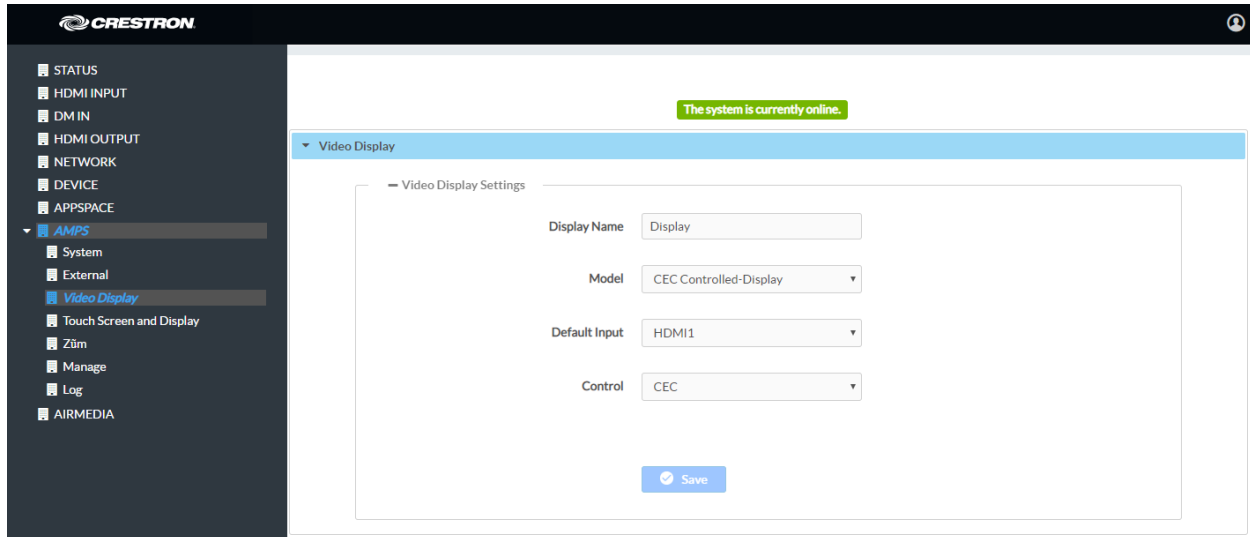

To configure the device to work with a connected display, follow this procedure:

1. In the **Display Name** field, enter a name for the connected display.
2. In the **Model** drop-down list, select the display that is connected to the device.

NOTE: If a control system is used with the AM-200 or AM-300, select **Non-Controlled Display** to use the AM-200 or AM-300's IR and RS-232 ports and the Control System to control the connected display.

3. Depending on the model selected, different controls are displayed. Complete the required fields to use the selected display.
4. Click **Save** to save the settings.

Touch Screen and Display

Click **Touch Screen and Display** to customize the function and appearance of the touch screen and the connected display.

AMPS Screen – Touch Screen and Display

The screenshot shows the Crestron AMPS web interface. On the left is a dark navigation sidebar with the following menu items: STATUS, HDMI INPUT, DM IN, HDMI OUTPUT, NETWORK, DEVICE, APPSPACE, AMPS (expanded), System, External, Video Display, Touch Screen and Display (selected), Züm, Manage, Log, and AIRMEDIA. The main content area is titled 'Touch Screen and Display' and features a green status bar at the top that reads 'The system is currently online.' Below this, the settings are organized into four sections:

- General:** Includes 'Hide Meeting Subject' (Disable), 'Hide Meeting Organizer' (Disable), 'Show Broadcast Message On Touch Screen' (Disable), 'Emergency Message Timeout' (10 Minutes), and 'Non-Emergency Message Timeout' (10 Minutes). A 'Save' button is at the bottom.
- Touch Screen:** Includes 'Enable Custom Backgrounds' (Disable). A 'Save' button is at the bottom.
- Display Notifications:** Includes 'Time Remaining Message Starts' (5 Minutes), 'Time Remaining Message Duration' (10 Seconds), and 'Next Meeting Information Shown' (5 Minutes Before Meeting Start). A 'Save' button is at the bottom.
- Display Customization:** Includes 'Hide Wired Cable Connection' (Disable), 'Cable Connection Details' (text input field), 'Show Calendar or Clock Overlay' (Disable), 'Show Background Overlay' (Disable), 'Enable Custom Logo Graphic' (Disable), and 'Enable Custom Backgrounds' (Disable). A 'Save' button is at the bottom.

General

The General section specifies what information is displayed on the touch screen and connected display.

- Set **Hide Meeting Subject** to **Disable** to have the meeting's subject shown. To hide the meeting's subject, set **Hide Meeting Subject** to **Enable**.
- Select **Hide Meeting Organizer** to **Disable** to have the meeting's organizer shown. To hide the meeting's organizer, set **Hide Meeting Organizer** to **Enable**.
- Set **Show Broadcast Message on Touch Screen** to **Enable** to show broadcast messages on the device's touch screen (broadcast messages are automatically displayed on the connected display). To prevent broadcast messages from showing on the device's touch screen, set **Show Broadcast Message on Touch Screen** to **Disable**.
- Enter the amount of minutes an emergency broadcast message is displayed in the **Emergency Broadcast Timeout** field.

NOTE: Emergency broadcasts are sent from Crestron Fusion. For more information on emergency broadcasts, refer to the Crestron Fusion® Software SSI Module Programming for SW-FUSION Reference Guide (Doc. 7898) at www.crestron.com/manuals.

- Enter the amount of minutes a non-emergency broadcast message is displayed in the **Non Emergency Broadcast Timeout** field.

When all changes are made, click **Save** to save the settings.

Touch Screen

Preloaded background images can be displayed on the device's connected touch screen. To select a background image for display:

1. Set **Enable Custom Backgrounds** to **Enable**. The Background drop-down list displays.
2. Select an image from the **Background** drop-down list.
3. Click **Save** to set the image as the background image on the device's connected touch screen display.

NOTE: For details on adding a touch screen, refer to "Add a Touch Screen" on page 59.

Display Notifications

The **Display Notifications** section configures how notifications are displayed while the device is in use.

- Enter the amount of time before the meeting's remaining time is displayed in the **Time Remaining Message Starts** field.

- Enter the amount of time the meeting's time remaining message is displayed in the **Time Remaining Message Duration** field.
- Enter the amount of time before the next meeting's information is displayed in the **Next Meeting Information Shown** field.

When all changes are made, click **Save** to save the settings.

Display Customization

The **Display Customization** section configures what is shown on the display device when not in use.

- Set **Hide Wired Cable Connection** to **Disable** and enter information in **Cable Connection Details** to display instructions for using cable connections. To hide information on cable connections, set **Hide Wired Cable Connection** to **Enable**.
- To show the clock and calendared events on the center of the display device, set **Show Calendar or Clock Overlay** to **Enable**. To remove the clock and calendared events from the center of the display device, **Show Calendar or Clock Overlay** to **Disable**.
- Set **Show Background Overlay** to **Enable** to place a monochrome filter over the background images. Set **Show Background Overlay** to **Disable** the filter and show background images in full color.
- A custom logo can be displayed in the lower right corner of the display device when the system is not in use. To use a logo or other graphic, set **Enable Custom Logo Graphic** to **Enable**, and enter the URL where the graphic is located in the **Custom Logo Graphic URL** field. When set to **Disable**, the Crestron logo is displayed.

NOTE: The optimal image size is 480 x 94 pixels. Custom graphics that are larger than 480 x 94 pixels are scaled down while maintaining their aspect ratio. Custom graphics that are smaller than 480 x 94 pixels are not scaled up and should be resized for optimal image display.

- A slideshow of custom backgrounds can be shown on the display device when the system is not in use. To use custom backgrounds, set **Enable Custom Backgrounds** to **Enable** and enter the URL where the background images are stored in the **Add Custom Background Url** field. To specify the length of time that each background image is displayed, enter a time (in seconds) in the **Interval Between Backgrounds** field.

NOTES:

- When Appspace is enabled, custom backgrounds cannot be used. For information on using Appspace, refer to "APPSPACE" on page 24.
 - The interface has been designed to use most of the screen area for informational purposes. This feature is intended to for use with corporate colors, branding, and aesthetics to the particular organization and should not be used to add custom instructions for room users.
-

When all changes are made, click **Save** to save the settings.

Zūm

The AM-200 and AM-300 can use Zūm™ wireless occupancy sensors and keypads to operate the presentation system. The **Zūm** screen is used to create Zūm networks, add Zūm devices, and monitor Zūm devices.

AMPS Screen - Zūm

Id	Model	Serial Number	Firmware Version	Battery Status	Status	Occupancy
N/A	ZUM-PIR-OCC-BATT	1737NEJ00287	0010000028		Active	
AVB	ZUM-AVBRIDGE	0000000	0010010004		Active	

Network

The **Network** section shows all the Zūm devices in the Zūm wireless network.

The **Zūm Bridge** field indicates the status of the ZUMMESH-AVBRIDGE Wireless Control Integration Module.

The **Zūm Sensor Status** field indicates the status of the ZUMMESH-PIR-OCCUPANCY-BATT Wireless Battery-Powered Occupancy Sensor.

Form a Network

The **Form Network** function is used whenever a new network needs to be created (i.e., after a ZUMMESH-AVBRIDGE is connected to the AM-200 or AM-300).

NOTES:

- Forming a network will erase any previously established network and remove and joined devices.
 - Zūm devices can be added and managed from ZUMMESH-AVBRIDGE and supported Zūm devices. Refer to "Add a Zūm Device to the Network" on page 58.
-

To form a new network:

1. Click **Form Network**. A new network is created with the ZUMMESH-AVBRIDGE as the center of the network. The ZUMMESH-AVBRIDGE also enters the Joining mode.
2. Acquire Zūm devices to the ZUMMESH-AVBRIDGE. For details on specific Zūm devices, refer to "Add a Zūm Device to the Network" on page 58.
3. Click **Stop Acquire** after acquiring Zūm devices. The ZUMMESH-AVBRIDGE will exit the Joining mode.

NOTE: The ZUMMESH-AVBRIDGE will automatically exit the Joining mode after four minutes.

Add a Zūm Device

Supported Zūm devices can be added to an existing network. For a list of supported devices, refer to "Supported Devices" on page 58.

To add a Zūm device:

1. Click **Start Acquire**. The ZUMMESH-AVBRIDGE enters the Joining mode.
2. Acquire Zūm devices to the ZUMMESH-AVBRIDGE. For details on specific Zūm devices, refer to "Add a Zūm Device to the Network" on page 58.
3. Click **Stop Acquire** after acquiring Zūm devices. The ZUMMESH-AVBRIDGE will exit the Joining mode.

NOTE: The ZUMMESH-AVBRIDGE will automatically exit the Joining mode after four minutes.

Manage

The **Manage** screen is used to enact the changes made in the web pages or revert to the previous settings.

When changes are made to the AMPS settings, the device goes offline and the screen below is shown.

AMPS Screen - Manage - System Offline

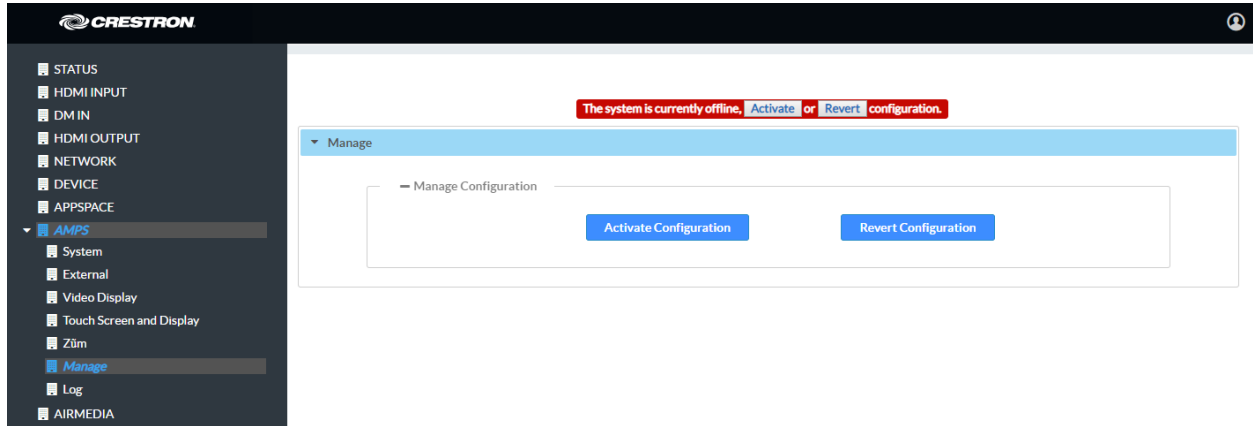

The connected display shows a message indicating that the system is currently offline. Additionally, if a touch screen is connected, it shows the following message.

Front Panel, System Configuration in Progress



Click **Activate Configuration** to carry out the changes that were made, or click **Revert Configuration** to revert back to the previously saved settings. The screen below is shown.

AMPS Screen - Manage - System Online

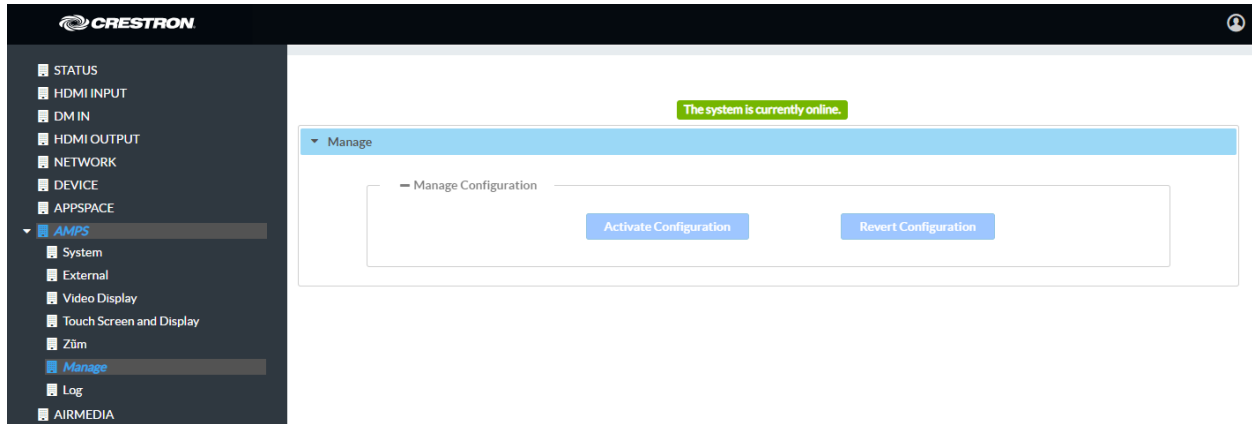

Log

The **Log** screen is used to view and download the device's message logs for analysis.

AMPS Screen - Log

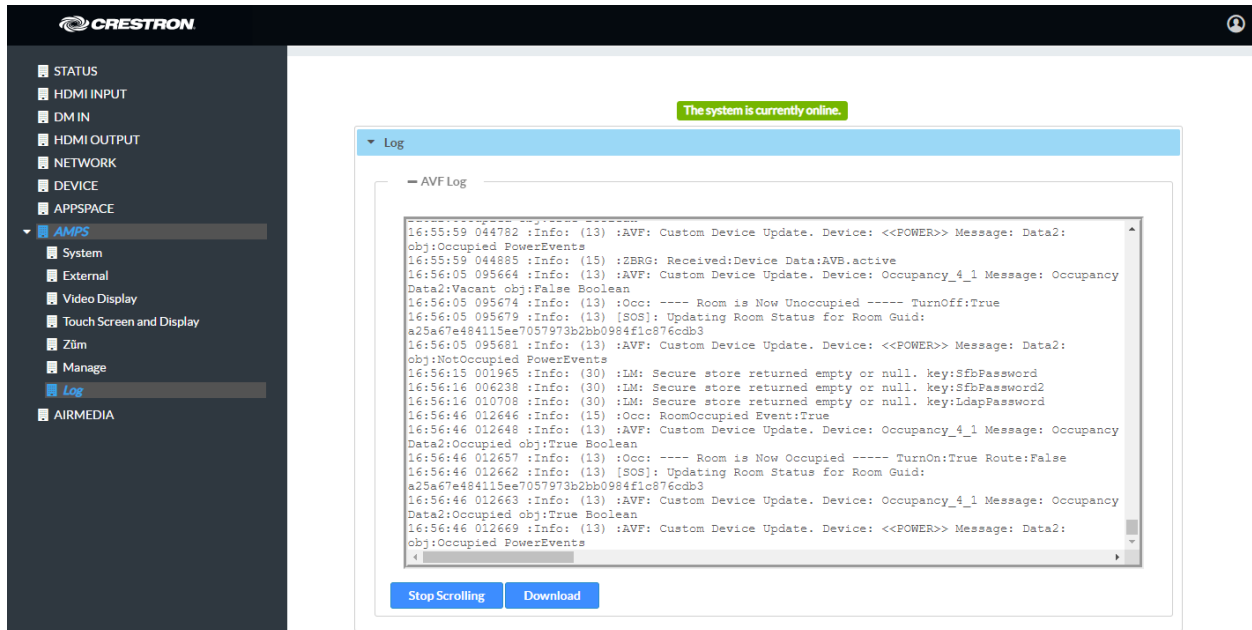

- Click the up or down arrows to scroll through the message log.
- Click **Stop Scrolling** to pause the message log. Click **Scrolling** to resume.
- Click **Download** to download the message log.

AirMedia

Click **AIRMEDIA** to configure the device's AirMedia functionality. The **AIRMEDIA** screen is displayed.

NOTE: For additional details on deploying AirMedia, refer to the AirMedia Deployment Guide (Doc 7693) at www.crestron.com/manuals.

AIRMEDIA Screen

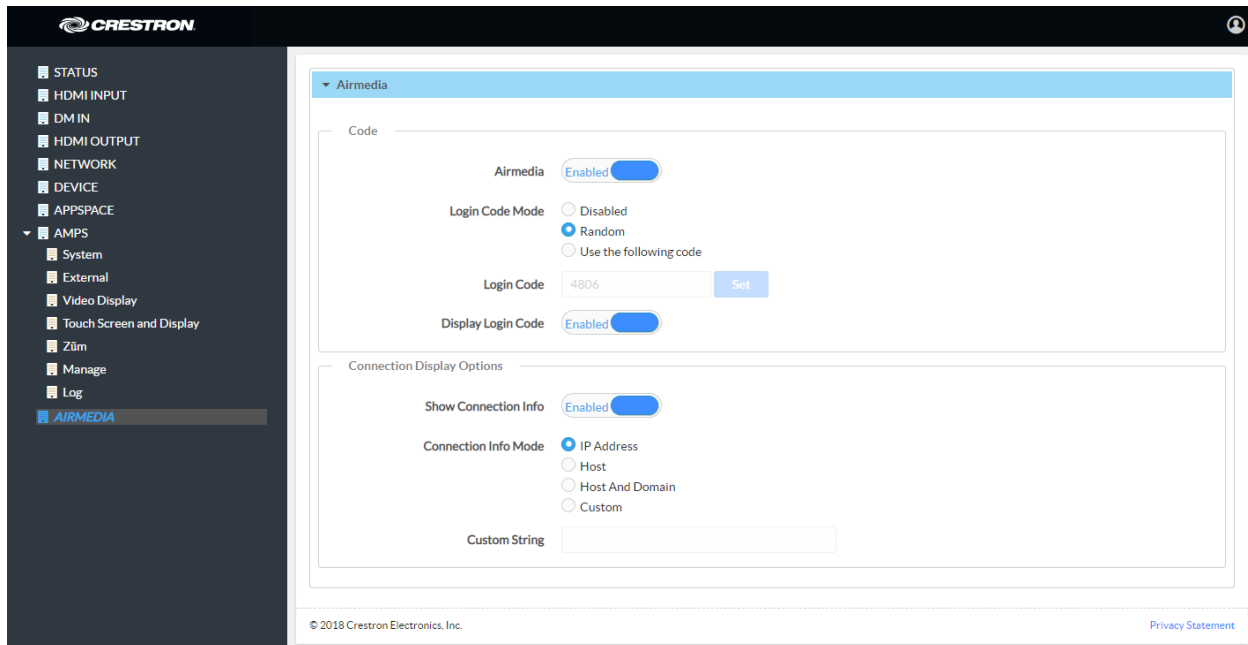

Code

To enable AirMedia for wireless presentation, set **AirMedia** to **Enabled**. To turn off **AirMedia**, set **AirMedia** to **Disabled**.

A code can be used to limit access to the device. The code feature can be disabled, randomly generated, or fixed to a specific value. Select one of the following Login Code Modes to specify how the access code is used:

- **Disabled** allows any user with the device's IP address or host name to open a client connection without entering an access code.
- **Random** sets the device to randomly generate an access code. A new code is generated when the last connected presenter disconnects from the device. The access code is displayed on the device's screen when AirMedia is selected.
- **Use the following code** sets the device to display a user-specified, four-digit access code. Enter a code in the **Login Code** field and click **Set**. The access code is displayed on the device's screen when AirMedia is selected.

To show the access code on the connected display when AirMedia is selected, set **Display Login Code** to **Enabled**. To hide the login code, set **Display Login Code** to **Disabled**.

Connection Display Options

Select whether connection information is displayed on the connected display device as well as what connection information is displayed.

- Set **Show Connection Info** to **Enabled** to display connection information on the display device. Set **Show Connection Info** to **Disabled** to hide connection information.
- If **Show Connection Info** to **Enabled**, select the **Connection Info Mode** to determine what connection information is presented to room visitors.
 - Select **IP Address** to show the IP address to use for connecting to the system.
 - Select **Host** to show the host name to use for connecting to the system.
 - Select **Host And Domain** to show the host name and domain name to use for connecting to the device.
 - Select **Custom** to a custom string to use for connecting to the system. If a custom string is to be used, enter it in the **Custom String** field.

Enterprise Deployment Options

Crestron has two options for deploying multiple AM-200 and AM-300 devices across an enterprise. These tools can assist in deploying any number of AM-200 or AM-300 devices that an organization may need to deploy.

For more information, refer to Answer ID 5719 in the Online Help section of the Crestron website (www.crestron.com/onlinehelp).

Crestron XiO Cloud Service

The Crestron XiO Cloud service requires devices to be claimed so they can be managed by the service. To claim a single device or multiple devices, perform one of the following procedures.

Claim a Single Device

1. Record the MAC address and serial number that are labeled on the shipping box or on a sticker attached to the device. The MAC address and serial number are required to add the device to the Crestron XiO Cloud environment.
2. Open a web browser, and log in to the Crestron XiO Cloud service at <https://portal.crestron.io>.
3. Click the **ENVIRONMENT** menu button (☰) to display the **Environment** menu.

Environment Menu

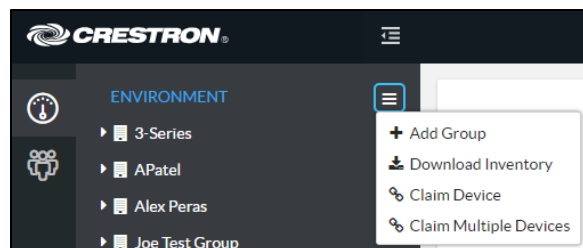

4. Click **Claim Device**. The **Claim Device** dialog box is displayed.

Claim Device Dialog Box

A screenshot of the 'Claim Device' dialog box. The title bar is blue and contains the text 'Claim Device' and a close button (X). The main area has a light blue background and contains the following text: 'Enter a device's MAC address and serial number to claim it for this account. Claimed devices appear in the "Unassociated Devices" group by default.' Below this text are two input fields: 'MAC Address' with the value '00.10.7f.5f.fe.9b' and 'Serial Number' with the value 'x0126456'. At the bottom of the dialog box are two buttons: 'Cancel' and 'Claim'.

5. Enter the MAC address and serial number recorded in step 1 in the MAC Address and Serial Number fields, respectively.
6. Click **Claim**. A message indicating a successful claiming displays.

NOTE: If an error message displays stating the device does not exist, connect the device to a network that has access to the Internet, wait 15 minutes, and then try again.

7. Click **X** to close the dialog box. The hostname of the claimed device appears in the device tree under the group **Unassociated Devices**.

The device can now be managed or assigned to a group. For information on creating environments, managing devices, and managing users with the Crestron XiO Cloud service, refer to the Crestron XiO Cloud Service User Guide Guide (Doc. 8214) at www.crestron.com/manuals.

Claim Multiple Devices

1. Record all of the MAC addresses and respective serial numbers in a comma delimited, CSV file, and then save it to a location that is accessible to the computer used to access the Crestron XiO Cloud service. The CSV file should be formatted as shown in the following image:

CSV File Format

```
MAC Address,Serial Number
00.10.7e.8b.81.b6,17284712
00.10.7e.8b.8c.87,17284570
00.10.7e.96.83.93,1716JBG01207
00.10.7e.96.92.0a,1716JBG01550
00.10.7e.8b.87.c1,17284670
```

NOTE: MAC addresses and serial numbers are labeled on the shipping box or on a sticker attached to the device.

2. Open a web browser, and log in to the Crestron XiO Cloud service at <https://portal.crestron.io>.
3. Click the **ENVIRONMENT** menu icon (☰) to display the Environment menu.

Environment Menu

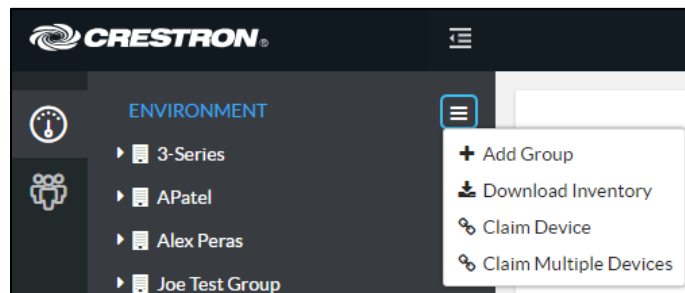

4. Click **Claim Multiple Devices** from the drop-down menu. The **Claim Multiple Devices** dialog box is displayed.

Claim Multiple Devices Dialog Box

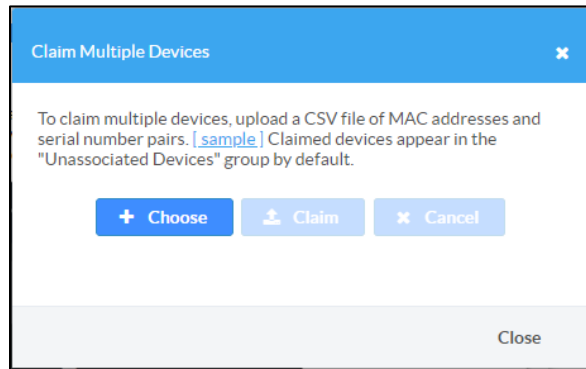

5. Click **Choose** and select the CSV file created in step 1.
6. Click **Claim** to claim all of the devices listed in the file. A message indicating the claim status of each device is displayed.

NOTE: If an error message displays stating the device does not exist, connect the device to a network that has access to the Internet, wait 15 minutes, and then try again.

7. Click **X** to close the dialog box. The hostnames of the claimed devices appear in the device tree under the group **Unassociated Devices**.

The devices may now be managed or assigned to a group. For information on creating environments, managing devices, and managing users with the Crestron XiO Cloud service, refer to the Crestron XiO Cloud User Guide (Doc. 8214) at www.crestron.com/manuals.

Crestron Deployment Tool for PowerShell® Software

Crestron has developed a tool for customers without the ability to use CPS to assist in deploying multiple devices without the need to configure each device individually. With this tool, an administrator has the ability to input all of the settings to be configured on multiple AM-200 and AM-300 devices, and then use PowerShell® task-based command-line shell and scripting language to configure the devices across a local network.

Operation

On its own, the AM-200 and AM-300 present content via the following connections:

- A device connected to the HDMI INPUT port
- A device connected to the DM IN port (AM-300 only).
- AirMedia

By default, the AM-200 and AM-300 present the input that was last connected. Optionally, a touch screen (sold separately or as part of a system) can be used to control the system. Additionally, a keypad (sold separately or as part of a system) can be used to adjust volume and turn the system on or off. For instructions on using a touch screen, refer to "Touch Screen Operation" below. For instructions on using a keypad, refer to "Keypad Operations" on page 50. Otherwise, continue below.

Connect a Source

Connect a device to the HDMI INPUT port or any of the inputs on a connected DM transmitter (AM-300 only). The last connected source is the device that is shown on the display connected to the AM-200 or AM-300.

Touch Screen Operation

While the AM-200 and AM-300 always display the last connected source, a connected touch screen can be used to switch the system power, switch between sources, and adjust volume. The home screen is displayed upon system startup.

NOTE: Depending on the device's configuration, some functions described here may not be available.

Home Screen

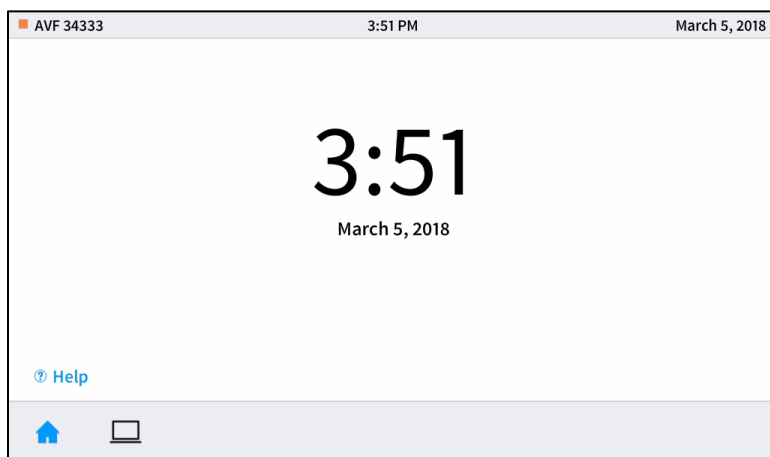

System Controls

The following controls are present on every screen.

System Power

Tap  to turn on system power. Tap again to turn off system power.



Home Screen

Tap  to return to the home screen.

Present

Tap  to view presentation options. For details on presenting refer to "Present Content" on page 48.

Volume Control

Tap + or - to raise or lower the volume.

NOTE: Volume controls are only present when the system is connected to a display that supports volume control.

Schedule a Meeting

The Home screen is used to reserve the conference room.

Tap  to display the Home screen. The Home screen displays the current status of the room.

Home Screen - Reserved Room

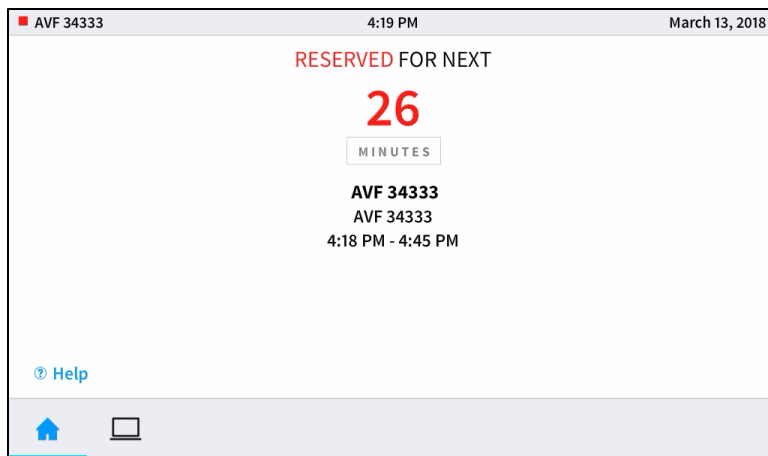

If the room is available for use, the display on the device indicates as such.

Home Screen - Available Room - Limited Time

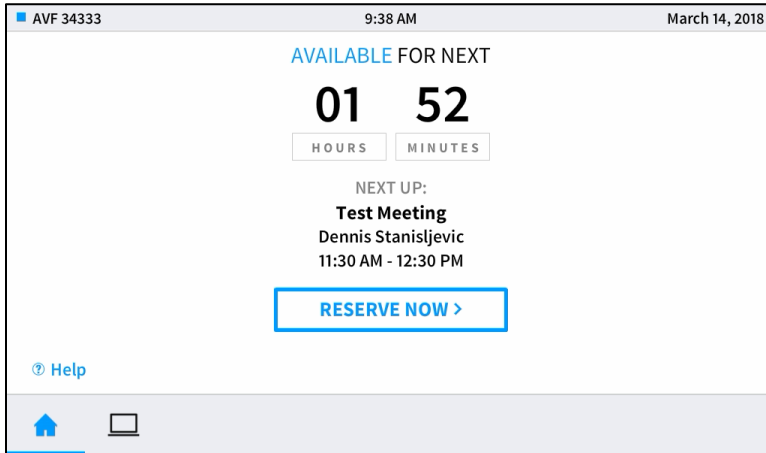

Home Screen - Available Room - Remainder of Day

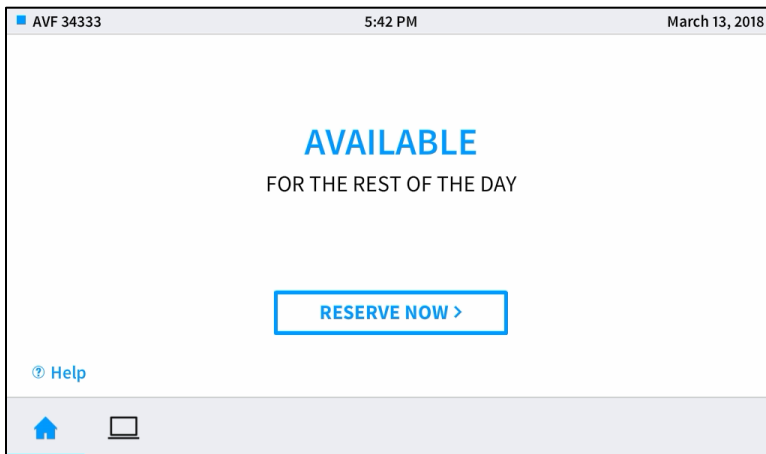

The user can either use the room for the remaining time available or create a new meeting for another time. To create a new meeting, follow this procedure:

1. Tap **RESERVE NOW** > to reserve the room. The **New Meeting** screen is displayed.

New Meeting Screen

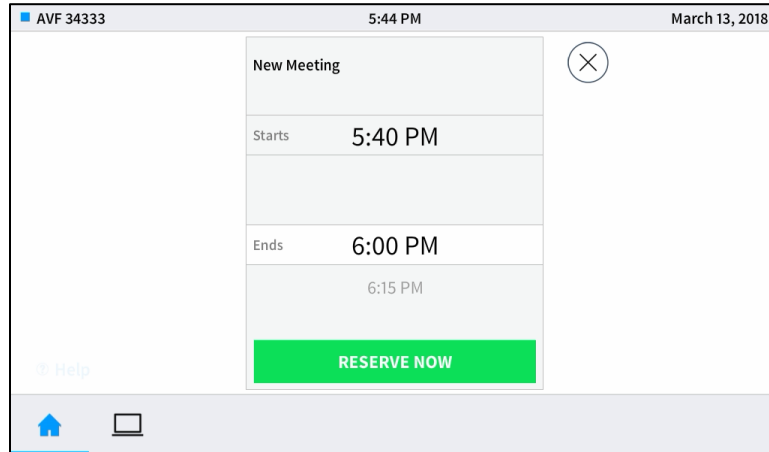

The meeting start and end times are automatically populated for the next available 30-minute block (*e.g.*, 5:30 to 6:00, 5:45 to 6:15, 6:00 to 6:30, *etc.*). When reserving a meeting space within a current 30-minute block, the start time is rounded down to the nearest 5-minute increment. For example, tapping **RESERVE NOW** at 5:44 pm creates a meeting with a start time of 5:40. If **RESERVE NOW** is tapped at 5:46 pm, the meeting start time would be 5:45 pm. The meeting end time may be set by the user.

NOTE: **RESERVE NOW** Meetings may only be scheduled for the current day from the device.

2. Scroll through the available end times to select the duration of the meeting. The room may be reserved for up to three lengths.
 - Until the current half hour interval ends (If the current time is 5:44 pm, the end time for this option is 6:00 pm.) This is the default setting.
 - Until the current half hour interval ends plus 30 minutes (If the current time is 5:44 pm, the end time for this option is 6:30 pm.)
 - Until the current half hour interval ends plus 60 minutes (If the current time is 5:44 pm, the end time for this option is 7:00 pm.)

NOTE: These options are available only if a meeting is not already scheduled during that timeframe.

3. Tap **RESERVE NOW** to book the room.

Present Content

Depending on the configuration, the system can present content from connected HDMI and DigitalMedia sources as well as content streamed from wireless devices over AirMedia. To view the different presentation options, tap . The **Present a Source** screen is displayed.

Present a Source Screen

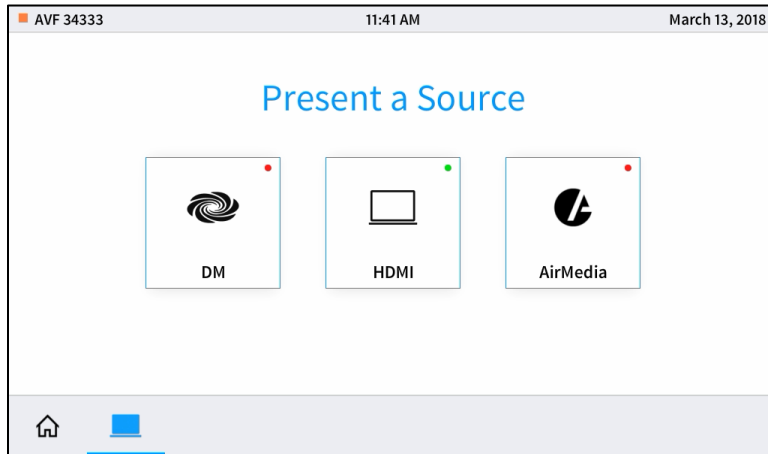

Sources that have a signal present are indicated with •. Sources that do not have a signal present are indicated with •.

Tap a source to present to the display device.

- Tap **DM** (AM-300 only) to display content from a device connected to a DM transmitter. When done presenting, tap **Stop**. To return to the previous screen, tap **< Back**.

Now Presenting DM Screen

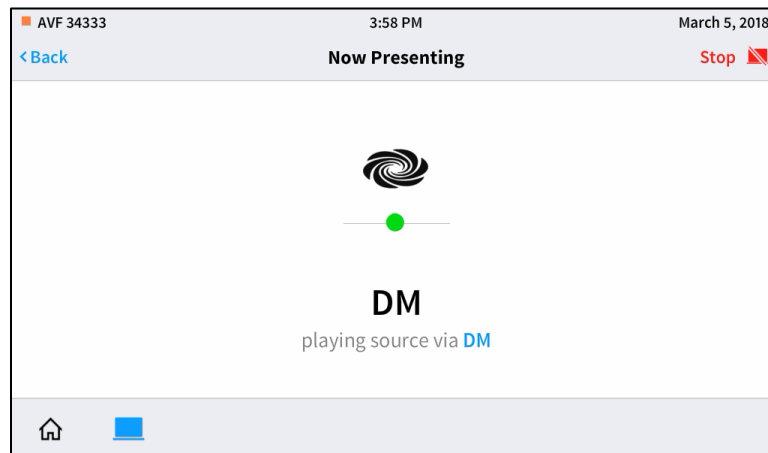

- Tap **HDMI** to display content from the device connected to the HDMI INPUT port. When done presenting, tap **Stop**. To return to the previous screen, tap **< Back**.

Now Presenting HDMI Screen

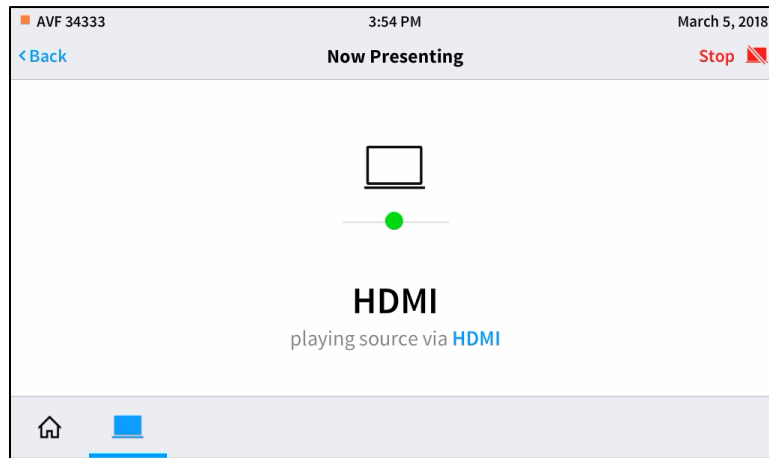

- Tap **AirMedia** to display content from a device connected through AirMedia. The **Connect to AirMedia®** screen is displayed.

Connect to AirMedia® Screen

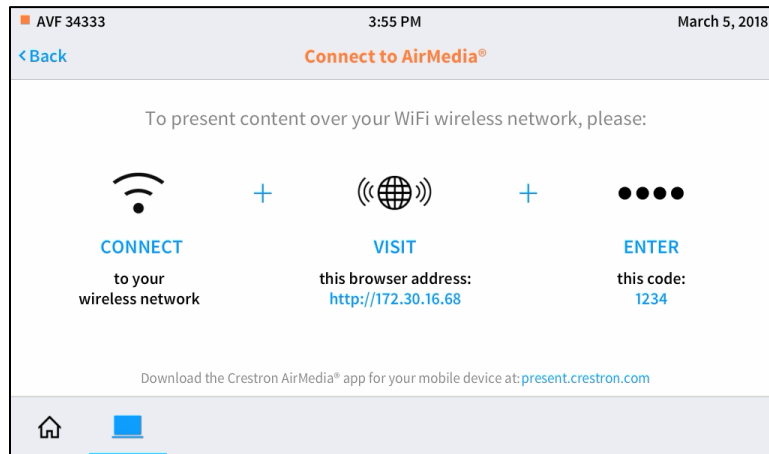

Refer to "Use AirMedia" on page 50 for instructions on connecting to AirMedia and sharing content.

When sharing content over AirMedia, the following screen is displayed. When done presenting, tap **Stop**. To return to the previous screen, tap **< Back**.

Now Presenting AirMedia® Screen

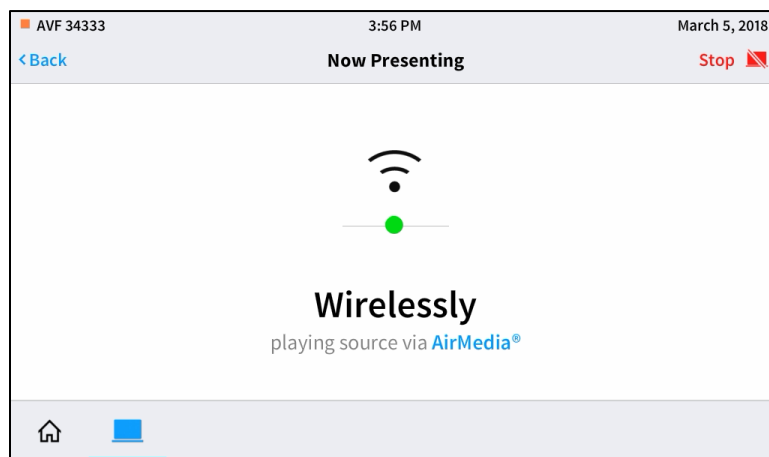

Keypad Operations

While the AM-200 and AM-300 always display the last connected source, a ZUMMESH-KP10AMBATT AirMedia keypad can be used to switch the system power and adjust volume.

NOTE: Züm devices are available in select markets. For a list of available markets, refer to Answer ID 1000127 in the Online Help section of the Crestron website (www.crestron.com/onlinehelp).

System Power

Tap **ON** to turn on system power. Tap **OFF** to turn off system power.

Volume

Tap **VOLUME UP** to raise the volume. Tap **VOLUME DOWN** to lower the volume.

NOTE: Volume controls functional when the system is connected to a display that supports volume control.

Use AirMedia

The AM-200 and AM-300 use a client application to share a Windows or Mac (hereafter referred to as "computer") desktop. The computer should be able to access the system over the network.

Crestron offers a stand-alone application for enterprise deployments. This application features additional connection methods and device management. For details, visit present.crestron.com.

Mobile devices can share their content using the Crestron AirMedia app or the Crestron PinPoint mobile app, which are available for iOS and Android™ devices. Both apps may be used for full screen sharing on devices running Android 5.0 Lollipop or iOS 8 and above. Download the latest version of these apps from the App Store® app in iTunes® software or Google Play™ store.

NOTE: For additional details on using AirMedia, refer to the AirMedia Deployment Guide (Doc 7693) at www.crestron.com/manuals.

Establish a Connection

From a Computer

1. Open a web browser on the computer, and navigate to the web address or IP address displayed on the display device. The welcome screen is displayed.

Welcome Screen

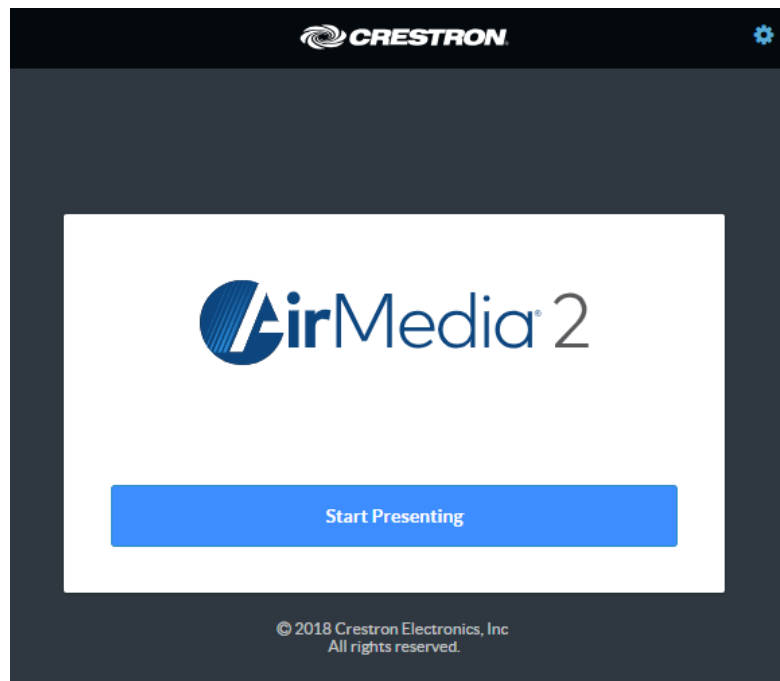

2. Click **Start Presenting**. The AirMedia 2 screen will display.

AirMedia 2 Screen

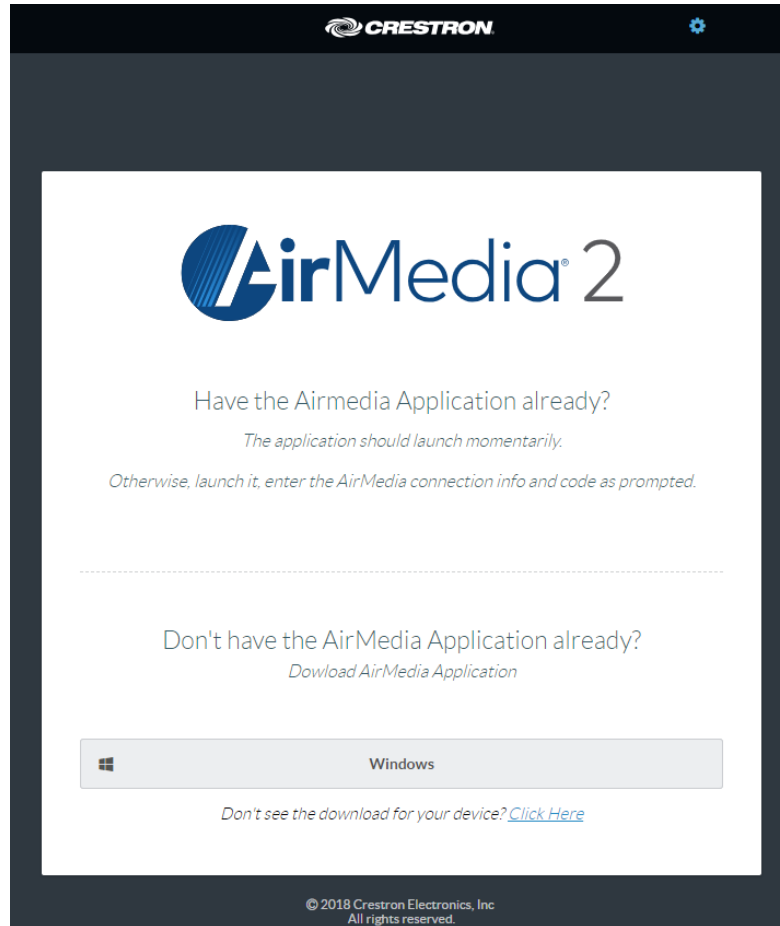

3. Click the icon for the computer's operating system to download the client application. The client application requires no installation. The application will be downloaded and run locally.

NOTE: When used on a Mac, the AirMedia client application must be run from within the disk image file. Do not drag the application out of the disk image file.

From a Wireless Device

1. Start the Crestron AirMedia app or the Crestron Pinpoint app.
2. Follow the onscreen instructions for connecting to an AM-200/AM-300.

Share Content

From a Windows Computer

Once the client application is downloaded, content can be shared.

1. Run the client application. The **Enter Code** dialog box is displayed.

Enter Code Dialog Box

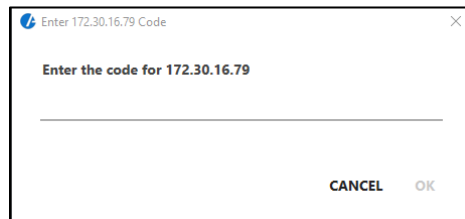

NOTE: If a code is not displayed, the presentation controls are displayed.

2. Enter the code displayed on the display device and click **OK**. The client establishes a connection between the computer and the AM-200/AM-300. The client also displays the presentation controls on the computer while the contents of the computer screen are shown on the display connected to the AM-200/AM-300.

Presentation Controls

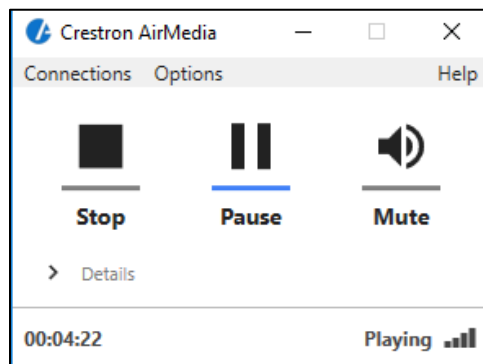

3. Direct the presentation with the following controls:
 - ■ Stop showing the computer's screen.
 - ▶ Start showing the computer's screen.
 - || Freeze the computer's screen.
 - 🔊 Mute the audio output to the device.
 - - Minimize the presentation control screen.
 - X Close the client application and the connection between the computer and the device.

- Click **Details** for additional controls and information.
 - The Video Source control allows the user to select between the primary desktop, additionally attached desktops, or an extended desktop (if available).
 - Information about the connected user, the name of the receiver, the IP address, and access code are displayed.
- Click **Options > Settings** to customize AirMedia settings. Adjust the settings below and click **OK** to save the changes or click **Cancel** to cancel.

AirMedia Settings Dialog Box

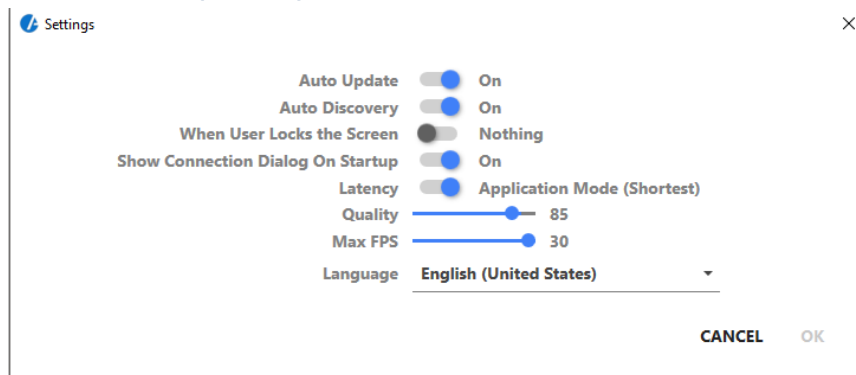

- **Auto Update** should be set to **On**.
- **Auto Discovery** should be set to **On**.
- **When User Locks the Screen** sets the operation of the client software when the connected computer is locked. Choose from **Stop** (the client stops sharing), **Pause** (the client pauses sharing), and **Nothing** (nothing happens).
- **Show Connection Dialog on Startup** selects whether connection information is displayed when the client starts.
- **Latency** selects the amount of latency in transmitting the signal from the computer to the AM-200/AM-300. Select **Application Mode (shortest)** for the least amount of latency (best for slides) or **Video Mode (Pre-Buffer)** for a longer amount of latency, but suitable for buffering shared video.
- Set the **Quality** of the projected signal (**0** to **100** percent).
- Set the **Max FPS** (frames per second) refresh rate (**1** to **30**).
- Select the **Language** displayed by the client application.

NOTE: The application must be restarted when switching languages.

From a Mac

Once the client application is downloaded, content can be shared.

1. Run the client application.
2. Follow the on-screen instructions.

From a Wireless Device

Follow the on-screen instructions for sharing content.

Appendix: AM-200 and AM-300 Systems

The AM-200 and AM-300 can be used as the centerpiece of an open presentation space.

Crestron offers the CE-600 (AM-200-based solution) and the CE-700 (AM-300-based solution). Each solution contains an AM-200 or AM-300, a Zūm™ AV bridge, an infrared probe, a wireless occupancy sensor, and required cables. The CE-700 adds a DigitalMedia transmitter.

Optionally, a customized solution may be assembled for application-specific needs.

Hookup Diagrams

The following diagrams show connections to the AM-200 and AM-300.

AM-200, Top

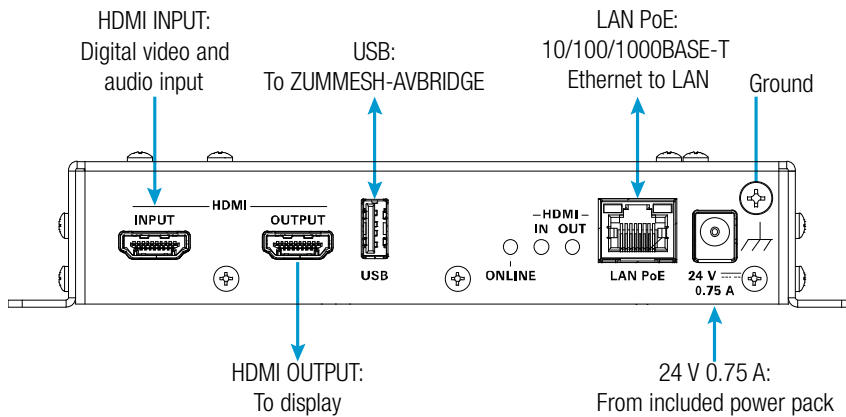

NOTE: The AM-200 can be powered by the included power pack or by Power over Ethernet (PoE).

AM-200, Bottom

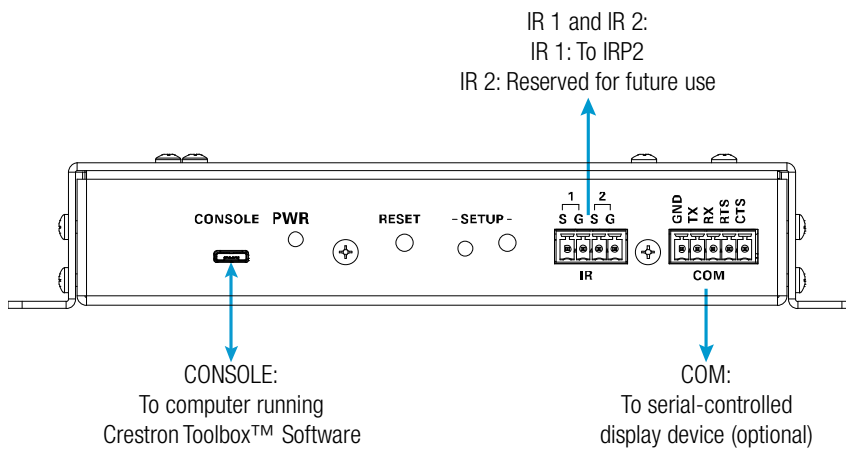

AM-300, Top

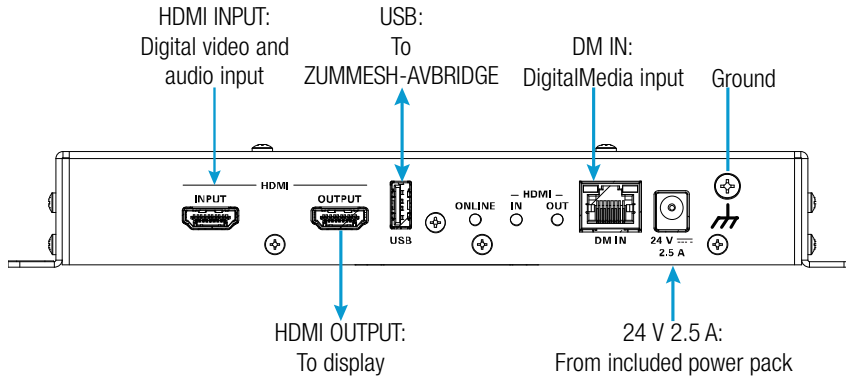

AM-300, Bottom

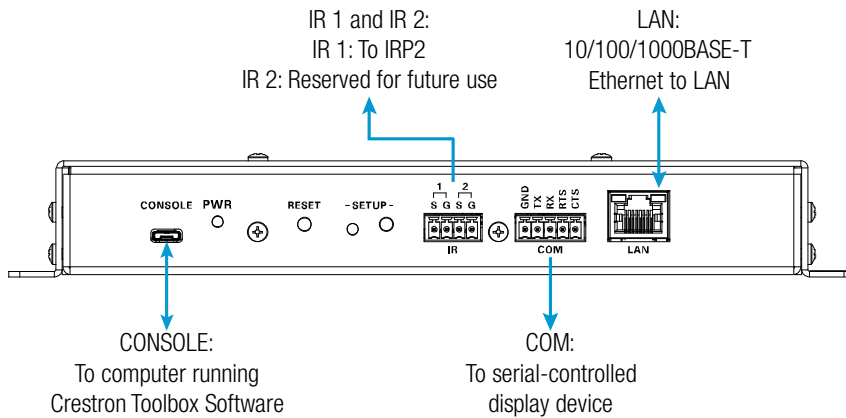

Supported and Tested DigitalMedia Transmitters (AM-300 Only)

A variety of DigitalMedia transmitters can be used with the AM-300. For a complete list of fully compatible DM transmitters, refer to Answer ID 1000107 in the Online Help section of the Crestron website (www.crestron.com/onlinehelp).

CAUTION: When using a DM transmitter equipped with a LAN port, do not connect the LAN port to the network or a network loop will be created that can disable the network. Only the AM-300 should have a network connection.

Zūm™ Devices

NOTE: Zūm™ devices are available in select markets. For a list of available markets, refer to Answer ID 1000127 in the Online Help section of the Crestron website (www.crestron.com/onlinehelp).

AM-200 and AM-300 systems can use a Zūm occupancy sensor and keypad for system control. A ZUMMESH-AVBRIDGE Wireless Control Integration Module (sold separately) is required to integrate the occupancy sensor and keypad into a system.

Supported Devices

The AM-200 and AM-300 support the following occupancy sensor and keypad:

- ZUMMESH-PIR-OCCUPANCY-BATT Zūm Wireless Battery-Powered Occupancy Sensor
- ZUMMESH-KP10AMBATT AirMedia Keypad

Add a Zūm Device to the Network

A Zūm device must be added to the system before operation.

NOTE: Zūm devices can be added and managed from the Zūm AMPS page. Refer to "Zūm" on page 35.

1. Connect the ZUMMESH-AVBRIDGE to the USB port on the AM-200 or AM-300. Refer to "Hookup Diagrams" on page 56 for details.
2. Apply power to the AM-200 or AM-300.
3. Insert batteries into the Zūm device(s) that are to be added to the network. Refer to the device's installation guide for instructions.
4. Create a Zūm space with the ZUMMESH-AVBRIDGE.

Press **SETUP** 5 times, then press and hold **SETUP** until the LED on the device lights (about 10 seconds). After approximately 3 seconds, the device LED begins slowly flashing, indicating that it is in Joining mode.

5. Add a device to the network.

- ZUMMESH-PIR-OCCUPANCY-BATT

Press the **TEST** button 3 times, then press and hold the **TEST** button until the LED on the device lights (up to 10 seconds). The ZUMMESH-PIR-OCCUPANCY-BATT is joined to the ZUMMESH-AVBRIDGE.

- ZUMMESH-KP10AMBATT

Press the top button on the keypad 3 times, then press and hold the top button until the LED on the keypad lights (up to 10 seconds). The LED on the keypad will start to flash slowly to indicate that the ZUMMESH-KP10AMBATT is joined to the ZUMMESH-AVBRIDGE.

6. Press a button on any of the devices to exit the Joining mode.

Monitor and Test Zūm Devices

For instructions on monitoring and testing Zūm devices, refer to either "Zūm" on page 35 or Answer ID 1000107 in the Online Help section of the Crestron website (www.crestron.com/onlinehelp).

Add a Touch Screen

The AM-200 and AM-300 support the use of a TSW-760 or TSW-1060 touch screen for system control. Adding a touch screen to the system requires an entry in the touch screen's IP table and loading a touch screen project file to the touch screen.

NOTE: The touch screen must be accessible to the AM-200 or AM-300 over the network.

IP Table Entry

An IP table entry must be created to direct the touch screen to the IP address or host name of the AM-200 or AM-300. For instructions on creating an IP table entry, refer to the TSW-560/TSW-760/TSW-1060 Supplemental Guide (Doc. 7927) at www.crestron.com/manuals.

Load a Touch Screen Project File

Load a touch screen project file to the system's touch screen.

For information on downloading the touch screen project file, refer to Answer ID 1000107 in the Online Help section of the Crestron website (www.crestron.com/onlinehelp).

For details on loading a touch screen project file, refer to the TSW-560/TSW-760/TSW-1060 Supplemental Guide (Doc. 7927) at www.crestron.com/manuals.

