

Cayin®

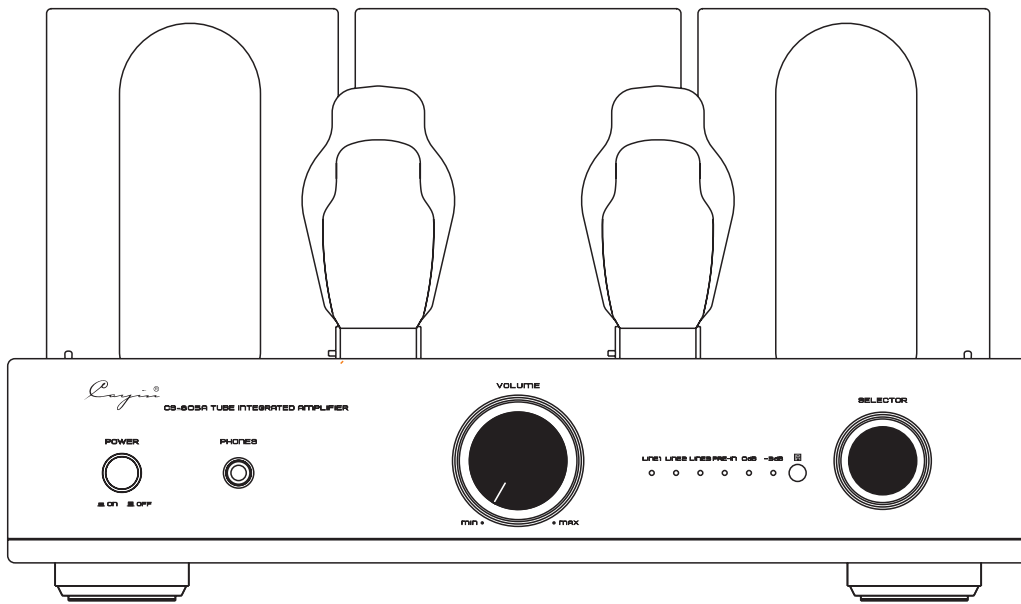

CS-805A | Vacuum Tube Integrated Amplifier

User's Manual

REV : 1.0



Thanks for choosing **CAYIN CS-805A** Vacuum Tube Integrated Amplifier and please read the user's manual carefully before installation and operation.

In order to prevent damage during transportation, the amplifier is packed with protective foams surrounding the tubes. Before installation and operation, please remove these foams to avoid any risks.

Table of Contents

Table of Contents	1
Package Contents	2
Product Features	3
Safety Precautions	3
Specifications	4
Maintenance	5
Warranty Service	5
Precautions	6
Front Panel	7
Rear Panel	8
Top Panel	9
Remote Control	10
Installation	11
Tube Replacement	11
Audio Connection	12
Speaker Connection	13
Turn on	14
Small Tips	14
Troubleshooting	15
How to Install Vacuum Tubes	16

NOTE:

CAYIN CS-805A Vacuum Tube Integrated Amplifier is designed and manufactured with our original parts and reaching the best results. We are not responsible for problems and damages caused by non-original parts replacement in the amplifier.

Package Contents

Please carefully check the package first and then open it.

Package contents include:

1. CAYIN CS-805A x1
2. Users' Manua x1
3. Power cord x1
4. Remote Control x1
5. (AAA) Battery of 1.5V x2
6. Spare Fuses:
 - ①.External Main Fuse x2 (~ 220V-240V : T3.15AL250V ; ~ 100V-120V : T6.3AL250V)
 - ②.Fuse for 805 tube x4 (T160mAL250V)

Recommendation:

Keep all packing materials for future use .

NOTE:

Please make sure local voltage level is matched with the input level of the amplifier, which indicates on the rear panel. Too low or too high voltage may cause problem. Please contact our company or our local agent if you've found improper voltage.

All other parts except above are not included.





Product Features

- ◆ Hand-made construction with the finest point-to-point wiring.
- ◆ Two EI output transformer with wide bandwidth are applied.
- ◆ Specially designed toroid transformer for power supply.
- ◆ 6SN7 vacuum tube has been used for voltage amplification.
- ◆ 300B vacuum tube with Porcelain base has been used for drive amplification.
- ◆ 805A vacuum tube has been used for Single-end Class A amplification.
- ◆ Switchable between different negative feedbacks. It outputs soft, clean, original sound if operated at -3dB NFB. Otherwise it output open, bold sound in details if operated at 0dB NFB.
- ◆ External 300B Hum Balance Adjustment is accessible.
- ◆ External user BIAS Adjustment is accessible with the BIAS meter for monitoring on the top of the amplifier.
- ◆ Equipped with remote control.
- ◆ Can be used as a Power Amplifier.
- ◆ CS-805A can memorize last operation of the unit once turned off.
- ◆ With high voltage delay function.
- ◆ High-quality Japanese ALPS motor potentiometer.
- ◆ Thickly silver plated signal cable has been used.
- ◆ Equipped with easily-installed tube cover for protection.

Safety Precautions

1. Unplug the power cord if you are not going to use the product for an extended period of time.
2. The machine will become hot after working for a long time. Please keep the unit's ventilation open and install the amplifier at a well-ventilated place to avoid troubles and fire hazard.
3. Forbidden to operate when the output is open or shorted.
4. Do not attempt to service this product yourself. Opening the cover may expose you to dangerous voltage or other hazards.
5. We are not responsible for any problems caused by checking and opening without permission of our company. For service, Please contact a qualified service technician.
6. Do not place any objects filled with liquids such as vases or some others on the top or around.
7. Clean only with dry cloth.
8. Please move the amplifier carefully not to drop the unit or be subject to other strong shocks.

	<p>CAUTION</p> <p>RISK OF ELECTRIC SHOCK</p> <p>DO NOT OPEN</p>	
---	--	---

- ◆ To reduce the risk of electric shock, do not remove the cover.
- ◆ No user serviceable parts inside. Refer servicing to qualified service personnel.
- ◆ To reduce the risk of fire or electronic shock, do not expose the unit to rain or moisture.

 The lightning flash with arrowhead symbol is intended to alert user to the presence of uninsulated “dangerous voltage” within the product’s enclosure that may be of a risk shock to persons.

 The exclamation point is intended to alert user to the presence of important operation and maintenance (servicing) instructions accompanying the appliance.

Specifications

Power Output	50W+50W	
Frequency Response	20Hz~35kHz (-3dB)	
THD	0.5% (1W/1kHz;10% Under Rated Power)	
S/N Ratio	93dB	
Input Sensitivity	300mV (Integrated)	
	1300mV (Pre-IN)	
Input Impedance	100kΩ	
Output Impedance	4Ω, 8Ω	
Input Terminals	LINE1, LINE2, LINE3, PRE-IN	
Tube	6SN7×2、300B×2、805A×2	
WDH	420mm×389mm×240mm	
Net Weight	38kg	
Max Power Consumption	450W	
Working Condition	Temperature : 0°C~40°C	Moisture : 20%~80%
Storage Condition	Temperature : -20°C~70°C	Moisture : 20%~90%



Maintenance

NOTE:

- ◆ Use the soft dry cloth to clean up the chassis regularly.
- ◆ Do not use any chemicals for cleaning.

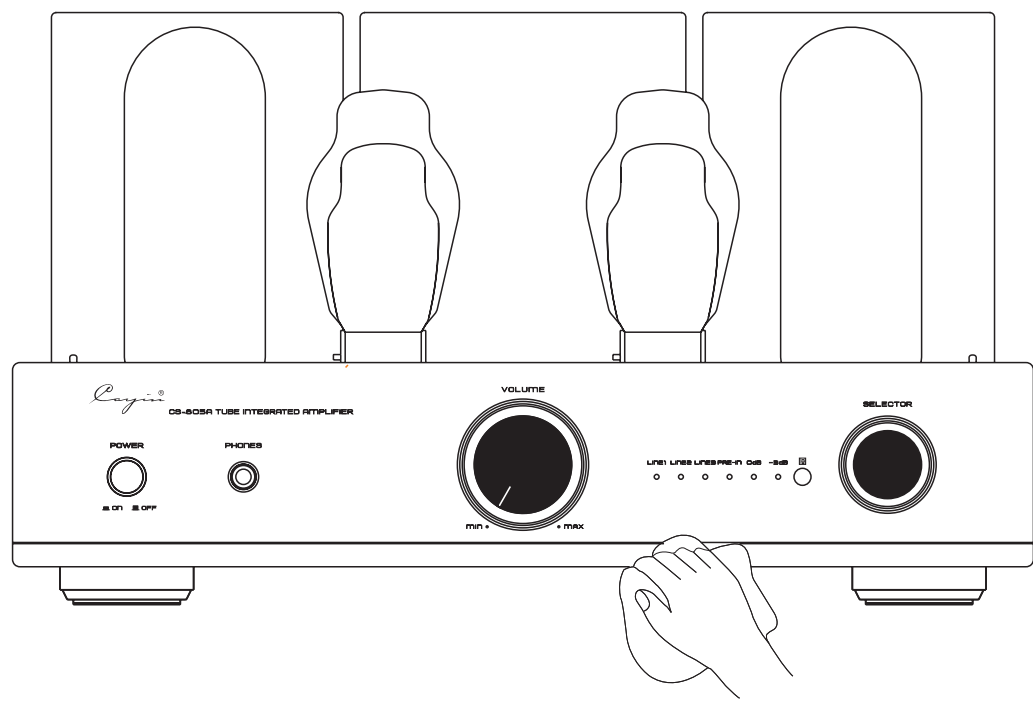

Warranty Service

- 1.This product is warranted for a period of twelve months beginning from the date of purchase.
- 2.The defective product must be returned to your dealer or our company for repairing when your dealer or our company accepts your requirement.
- 3.The warranty doesn't extend to any product that has been opened by you without permission of our company.

NOTE:

The information in this manual is subject to change without further notice.

Precautions

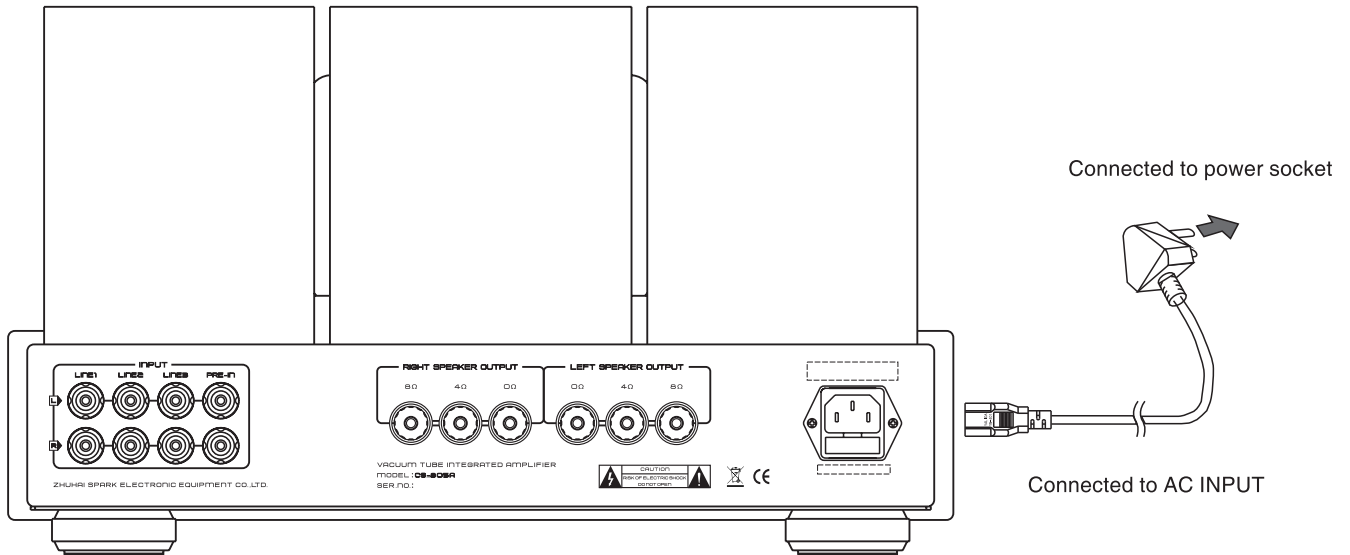

Connection of power cord:

Connect the speaker cables and signal cables first and then insert the power cord into the power socket.

NOTE:

- ◆ Connect the power only after finishing other connections.
- ◆ It is normal that power transformer becomes hot for extended period of operation.
- ◆ Unplug the power cord if you're not going to use the product for an extended period of time.
- ◆ Please make sure corresponding voltage is the same as required. We are not responsible for damage caused by misuse of unsuitable voltage.



Front Panel

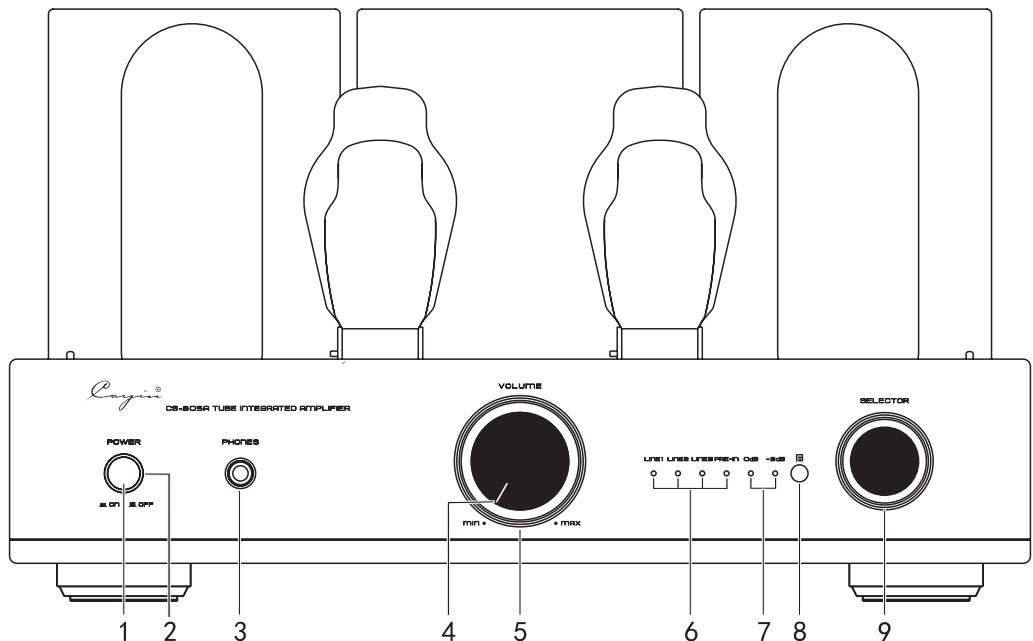

1. Power Switch

Used to switch on/off the amplifier.
Note: Unplug the power cord if you're not going to use the product for an extended period of time.

2. Power indicator

Turn on the amplifier the power indicator will be on.

3. Headphone Jack (PHONES)

Enjoy the music with your headphone if you prefer.

4. Power Indicator

Used to indicate the working state. The indicator will be on when it is working normally. The indicator will flicker for 30 seconds when it delays to work.

5. Volume Knob

Used to control volume

6. Input Selector Indicator

You can hear sound from LINE1 when LINE1 indicator is on.
You can hear sound from LINE2 when LINE2 indicator is on.
You can hear sound from LINE3 when LINE3 indicator is on.

You can hear sound from PRE-IN when PRE-IN indicator is on.

Cayin CS-805A can memorize last operation of the unit once turned off.

7.NFB. Indicator

The NFB. -3dB indicator will be on when it is -3dB;

The NFB.0dB indicator will be on when it is 0dB.
Cayin CS-805A can memorize last operation of the unit once turned off.

8. IR Remote Sensor

Used to receive the code of remote control. working state.

9. Input Selector Knob

Used to select four kinds of audio sources. The input selection indicator will be on according to the input audio sources. This function can be operated on the remote control.

Rear Panel

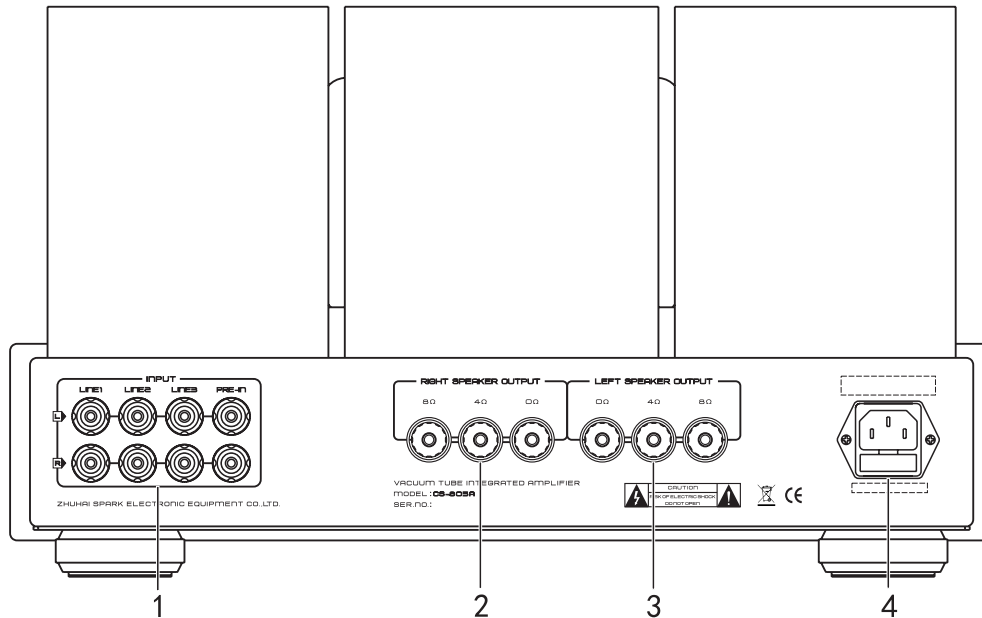

1. Signal Input Terminal

Used for audio source input.

2. Right Channel Output

Used to connect with the right channel of speaker.

3. Left Channel Output

Used to connect with the left channel of speaker.

4. Power Socket with Main Fuse

Main fuse is located just below the power socket.

Replace the fuse with the same type and value.



Top Panel

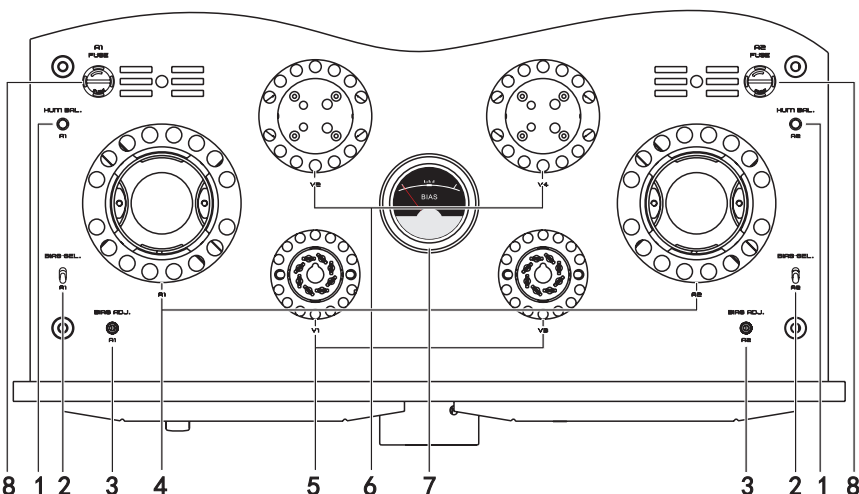

Diagram 4
Bias meter when not working

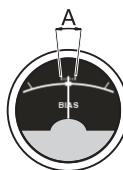

Diagram 5
Bias meter during working
Note: When working normally, the pointer should stay within the A zone, still, it would move for the voltage fluctuation.

1. HUM BALANCE Adjustment Switch(A1、 A2)
2. Bias Selector Switch(A1、 A2)
Used to select corresponding tube for bias adjustment.
3. Bias Adjustment Switch(A1、 A2)
Used to adjust bias of corresponding power tube(A1、 A2)
4. A1、 A2:805A Tube
5. V1、 V3:6SN7 Tube
6. V2、 V4:300B Tube
7. Bias Meter
Used to monitor the working current of the power tube.
8. External Fuse for high voltage
(T160mAL250V)

How to adjust the HUM:

Turn the volume knob to the minimum or mute and adjust the HUM BALANCE with the flat screwdriver until you heard the smallest HUM. Do the same for adjusting the other channel.

NOTE:

- 1.Be careful of the high temperature of the tubes during operation.
- 2.Replace the tubes carefully and correctly.
- 3.Power tubes must be matched for well function.

Bias adjustment for the power tube:

Turn the Bias Selector Switch to its opposite direction without releasing it, adjust the corresponding Bias Adjustment Switch with flat screwdriver, and inspect the Bias Meter on the top panel to make sure the pointer keeps in the center. Bias adjustment for A1 A2 are the same. After all have been adjusted, do it one more time to make sure all the bias levels of A1,A2 are the same.

Sample of bias adjustment for power tube A1:

1. Turn the Bias Selector Switch A1 to its opposite direction without releasing it.
2. Adjust the corresponding Bias Adjustment Switch A1 with flat screwdriver until the pointer of the bias meter keeps in the center.
3. Adjustment for A2 are the same.

Remote Control

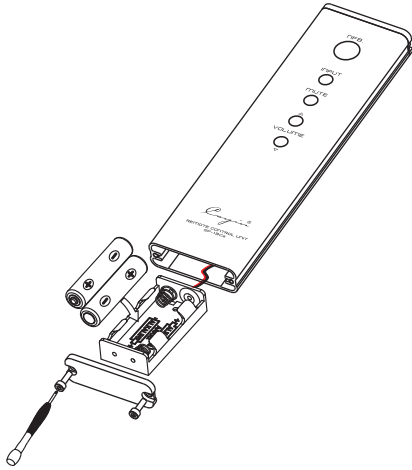

Installation

1. Place the remote control upside up. Screw the rear cover open with the screwdriver.
2. Pull out the battery case carefully (do not break the wires connected).
3. Put in the batteries with correct polarity.
4. Push in the battery case and screw the rear cover close.

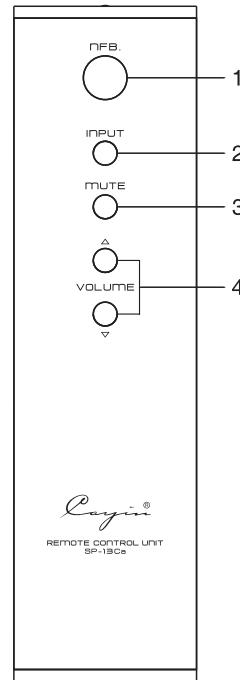

1. NFB. Selector
2. Audio Source Input Selector
3. Mute Button
4. Volume Control Selector

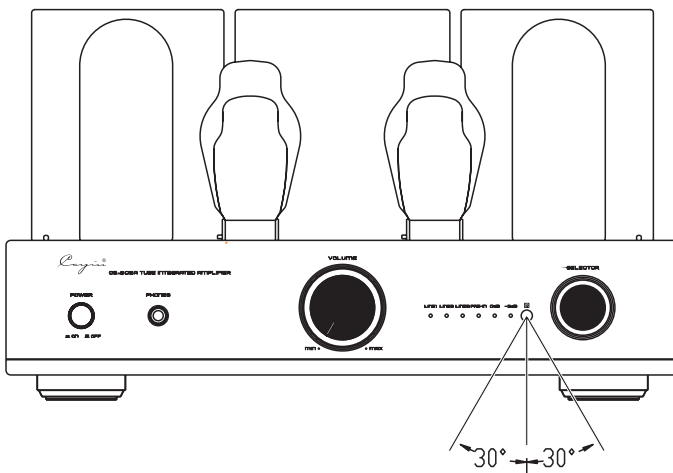

Effective Distance : about 6m

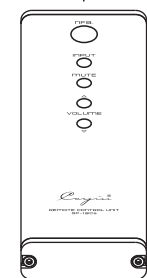

NOTE:

- ◆ Don't drop the remote control. Keep the remote control dry.
- ◆ Replace the batteries timely.
- ◆ Don't mix new and old batteries together and use the batteries with the same specification.
- ◆ Take out the batteries if you don't use the remote control for an extended period of time.
- ◆ Batteries with high quality are recommended.



Installation

Carefully read and follow the manual for installation:

- ◆ Do not place the machine near heat sources such as radiators, heat registers or other products that produce heat.
- ◆ In order to avoid being overheated please keep the unit's ventilation open.
- ◆ Do not expose this appliance to rain or moisture.
- ◆ Keep the amplifier in a certain distance so that it can be easily connected.
- ◆ Amplifier should install steadily and make sure all four feet are on the same level.
- ◆ Keep the amplifier over 15cm's distance to the surrounding walls.

NOTE:

Please make sure local voltage level is matched with the input level of the amplifier, which indicates on the rear panel. Too low or too high voltage may cause problems or shorten the amplifier's life.

Tube Replacement

Tubes for the Machine	Tube Replacement
6SN7	6SN7GT、6H8C、ECC32、6N8P
300B	300B
805A	805(Need to connect the self-made 805 tube cap to the plate high Itage power supply.)

Audio Connection

Connection method of **CAYIN CS-805A** with other audio equipments Take pictures below for your reference.

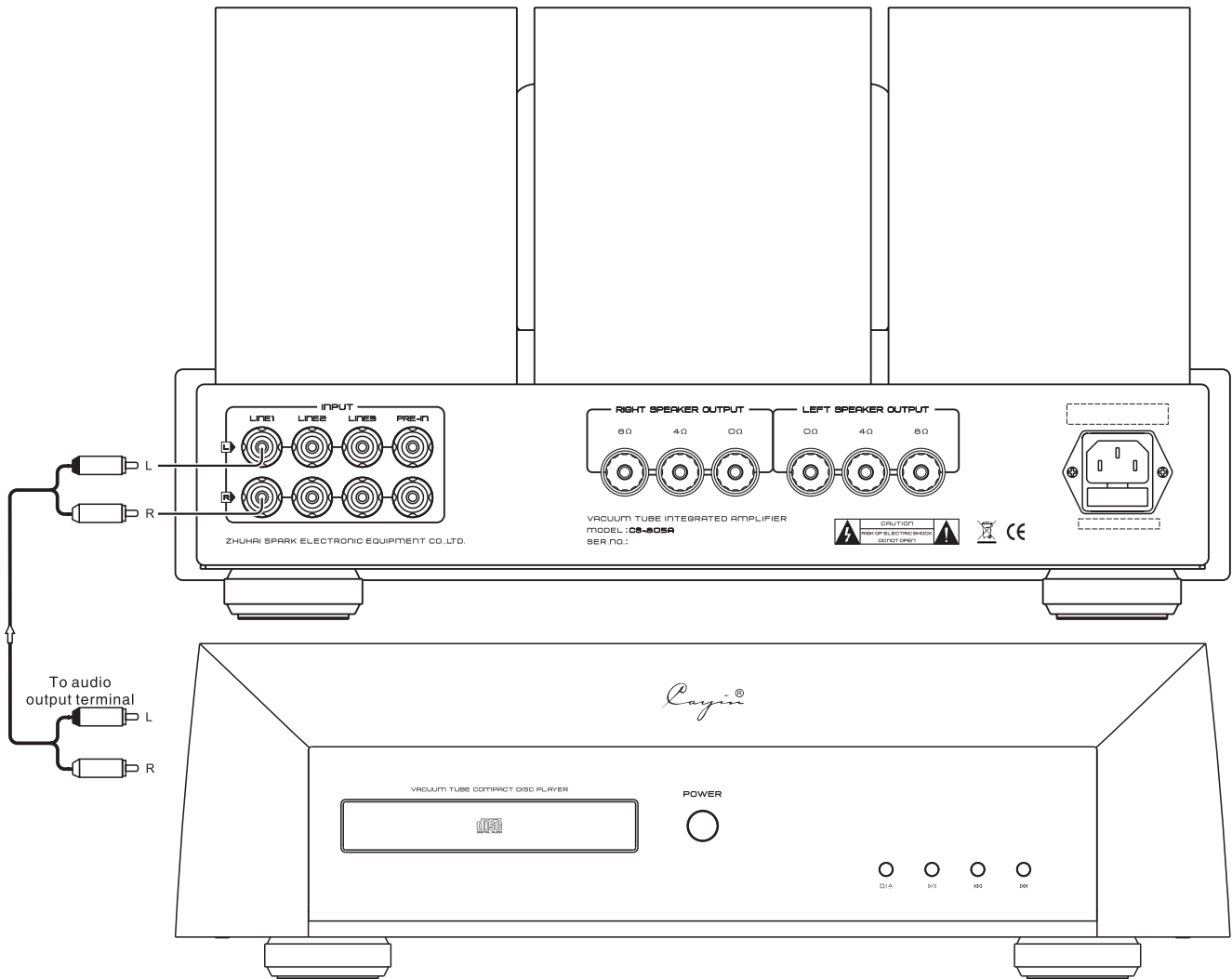

NOTE:

- Please refer to the manuals of other connected equipments during the installation.
- Do not insert the power cord into the main socket before all other equipments are well connected.
- R refers to right channel while L represents left channel.
- Please take the right guidance for connection as wrong connection may cause noise, low-grade function or damage.
- Do not fasten signal cable together with power cable and speaker cables. It will worsen the acoustic fidelity.

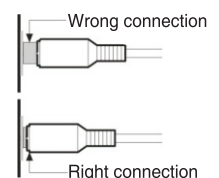



Speaker Connection

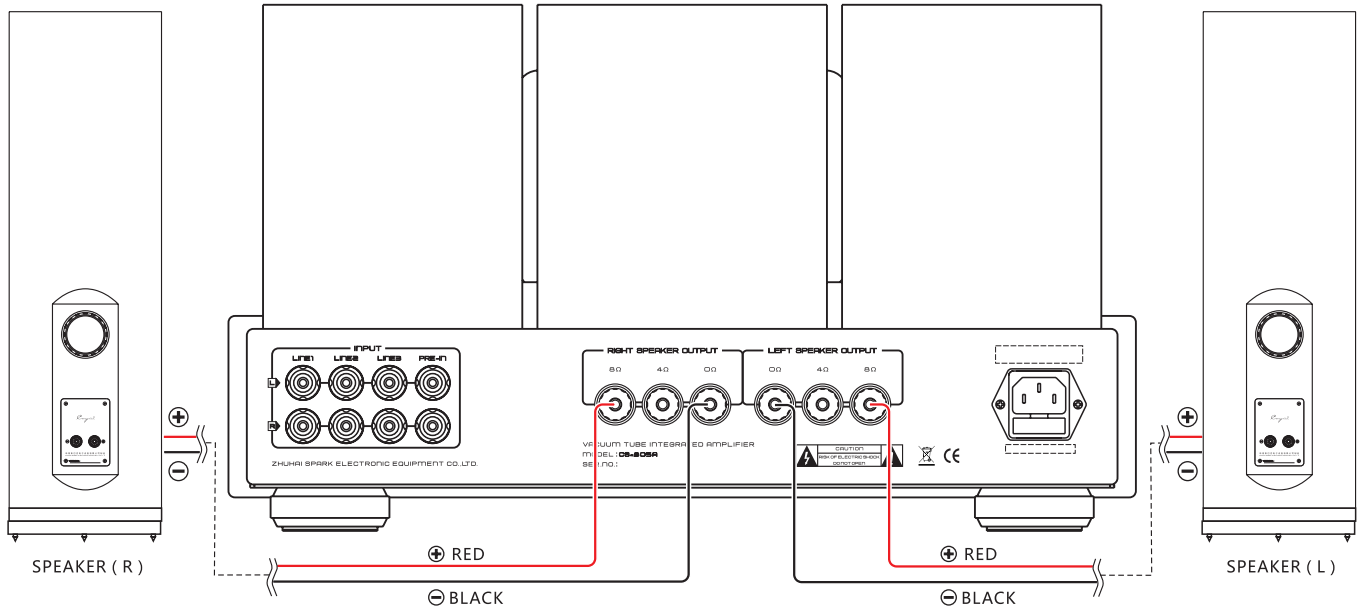

Check the impedance of your speakers:

Attach the positive from your speaker to the 4 or 8 ohm terminal and the negative to the 0 ohm terminals separately. If your speakers are 6 ohm, 4 ohm or 8 ohm (recommended) terminal is preferential and it would not cause damage to the amplifier. Connecting the left and right speakers according to the guidance can make sure of the acoustic fidelity.

Connection of speaker cables:

1. Unscrew the terminal knob
2. Insert the speaker cable
3. Screw the terminal knob

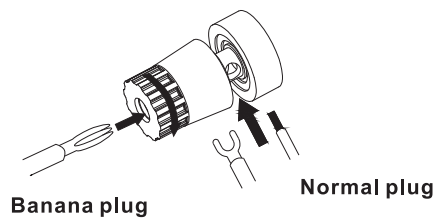

NOTE:

- Connect the speaker cables with the amplifier after it is well connected with the speakers.
- Connect both of the speakers to make sure of the acoustic fidelity.
- Please notice the signal direction indication of the cables.
- Do not mix up the positive and negative ends of speaker cables or it will cause short circuit.

Turning On

Before turning on the amplifier please make sure all connections are right and power supply is stable.

- Turn on the amplifier, the power indicator will be on and the working indicator will keep flickering.
- The working indicator will be on after 30 seconds. It means that the amplifier is working normally. If the working indicator is off, please turn off the power and contact with our local agent or our company.
- Select the right audio source channel, adjust the volume to a certain position and then you can enjoy the music you prefer.

NOTE:

1. When the audio system is under working state, don't unplug the signal cable or speaker cables, or it will cause damage to the amplifier and other equipments.
2. It should at least takes 2 minutes before you turn on the power again, or it will cause damage to the vacuum tubes.

Small Tips

Read the Manual — Please read the user's manual carefully before installation and operation.

Keep the Manual — Please keep the manual for future reference.

Warning Signs — Don't tear off or rub off the serial number.

Operation — Do the operations as you are instructed in the Manual.

Parts — If you are going to use parts not supplied by our company like power cord, fuses etc please make sure that parts you used are compatible with the safety requirements. Or it will cause fire or electric shock.

Placement — Put the amplifier on a level place. Make sure that it doesn't bring damage to the children, adults and the amplifier itself.

Power — Please make sure the local voltage is the same level as indicated on the rear panel.

Overload — If the power socket is overloaded with other equipment, it will cause fire or electric shock.

Warranty Service — Do not open the product and change the components inside yourself. Opening the cover may expose you to dangerous voltage or other hazards. The warranty doesn't extend to any product that has been opened by you without permission of our company.

Troubleshooting — If any problems when you are using the product, please check according to following tips to look for the exact reason. Please contact with our company if you can't solve the problem.



Troubleshooting

Please follow the instruction in the manual in order to keep the amplifier work in its best state. If wrongly operated and you thought that would be troubles please check according to following tips to look for the exact reasons.

Problem		Cause	Remedy
NO OUTPUT	Power Indicator is OFF.	Power cord is not well-connected.	Check power cable connection or power outlet connection
		Main fuse is out.	Replace with the same type and value fuse.
		Troubles of inner parts or components.	Please contact with local agents or our company.
	Power Indicator is ON.	Volume is at ZERO.	Turn up the Volume.
		NO signal input.	Check the function of the sound source.
			Check the input selection and switch to the proper input.
Sound Distortion	High input signal level.	Turn down the volume to suitable position.	
Noise output	Ground of input signal cable is open or bad contact of the input signal cable.	Replace the input signal cable with a new one.	
	Components or circuits are in trouble.	Please contact with local agents or our company.	
Sound field Positioning is not so good.	Signal input cables or speaker cables are wrongly connected.	Reconnect it as suggested in the manual.	
Malfunction of Remote Control	Be disturbed.	Keep away from the source of disturbance. Turn off and restore.	
	Low Battery.	Replace with new batteries.	
	Obstacles between the amplifier and remote.	Remove the obstacles.	

NOTE: *Rayin*[®] is the registered trademark of Zhuhai Spark Electronic Equipment Co., Ltd.

How to Install Vacuum Tubes

How to Install 9-Pin Vacuum Tubes

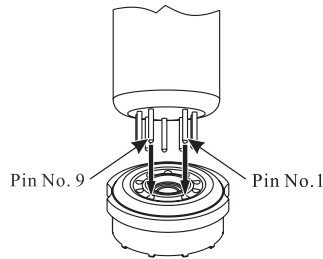

Applicable vacuum tube:
 12AU7 (ECC82)、12AX7 (ECC83)、5BK7、12BH7、
 12AT7 (ECC81)、6922 (ECC88), etc. 9-Pin vacuum tubes.

Instructions to Change and Install the vacuum tubes:
 To install a nine-pin vacuum tube, align the pins of the vacuum tube with the holes of the tube socket and insert the tube vertically up and down (as shown in the figure above).

▲ Please note that when installing the nine-pin vacuum tube, pay attention to the alignment of the vacuum tube pins with the holes of the tube socket. Otherwise wrong insertion will cause damage to the vacuum tube and prevent the amplifier from working properly, which may lead to failure of the amplifier.

How to Install 8-Pin Vacuum Tubes

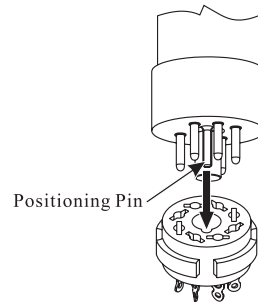

Applicable vacuum tube:
 KT150、KT170、KT88、6550、EL34、6V6、6SN7、6SL7、5AR4, etc. 8-pin vacuum tubes.

Instructions to Change and Install the vacuum tubes:
 To install an eight-pin vacuum tube, align the positioning pin of the tube with the grooves in the positioning holes of the tube socket, and install the tube by pulling up and down vertically (as shown in the figure above).

▲ Please note that when installing the eight-pin vacuum tube, pay attention to the alignment of the vacuum tube positioning pin with the positioning hole of the tube socket. Otherwise wrong insertion will cause damage to the vacuum tube and prevent the amplifier from working properly, which may lead to failure of the amplifier.

How to Install 4-Pin Vacuum Tubes

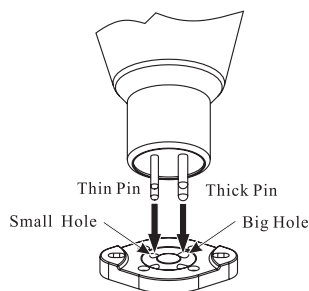

Applicable vacuum tube:
 300B、2A3 etc. 4-pin vacuum tubes .

Instructions to Change and Install the vacuum tubes:
 To install a four-pin vacuum tube, please pay attention to the thickness of different pins of the vacuum tube and the size of the tube socket hole. Thick pin should be aligned with the big hole, and the thin pin should be aligned with the small hole. Install the tube vertically up and down (as shown in the figure above).

▲ Please note that when installing the four-pin vacuum tube, pay attention to the thickness of different pins of the vacuum tube and the size of the tube socket holes. Otherwise wrong insertion will cause damage to the vacuum tube and prevent the amplifier from working properly, which may lead to failure of the amplifier.

How to Install Big 4-Pin Vacuum Tubes

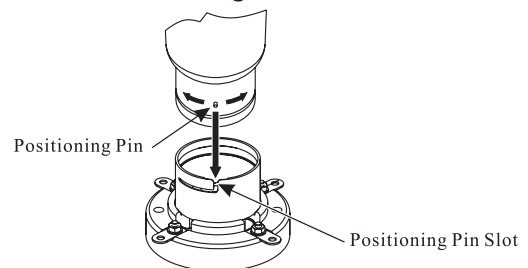

Applicable vacuum tube:
 845、805、211 etc. 4-pin vacuum tubes.

Instructions to Change and Install the vacuum tubes:
 To install the big four-pin vacuum tube, align the vacuum tube positioning pin with positioning pin slot of the tube socket and then rotate 45° clockwise to tighten. (As shown in the picture above). To take out the big four-pin vacuum tube, turn the tube 45° counterclockwise and take it out upward after loosening.

▲ Please note that when installing the big four-pin vacuum tube, pay attention to the alignment of the vacuum tube positioning pin with positioning pin slot of the tube socket and then rotate 45° clockwise to tighten. It is strictly forbidden to install the vacuum tube when the positioning pin is off or missing. Otherwise wrong insertion will cause damage to the vacuum tube and prevent the amplifier from working properly, which may lead to failure of the amplifier.