MOON 780D v2

Streaming DAC



Owner's Manual

M O O N

by SIMAUDIO

Important Safety Instructions

1. Read these instructions.
2. Keep these instructions.
3. Heed all warnings.
4. Follow all instructions.
5. Do not use this apparatus near water.
6. Clean only with a dry cloth.
7. Do not block ventilation openings. Install in accordance with the manufacturer's instructions.
8. Do not install near any heat sources such as radiators, heat registers, stoves or another apparatus that produces heat.
9. Do not defeat the safety purpose of the polarized or grounding type plug. A polarized plug has two blades with one wider than the other. A grounding-type plug has two blades and a third grounding prong. The wide blade or the third prong is provided for safety. If the provided plug does not fit into the outlet, consult an electrician for replacement of the obsolete outlet.
10. Protect the power cord from being walked on or pinched, particularly at plugs, convenience receptacles, and the point where they exit from the apparatus. Unplug mains cord during transportation.
11. Only use attachments and accessories specified by the manufacturer.
12. Use only with the cart, stand, tripod, bracket, or table specified by the manufacturer or sold with the apparatus. When a cart is used, use caution when moving the cart/apparatus combination to avoid injury from tip over.
13. Unplug this apparatus during lightning storms or when unused for long periods of time.
14. Refer all servicing to qualified service personnel. Servicing is required when the apparatus has been damaged in any way, such as when the power cord or plug has been damaged; liquid has been spilled or objects have fallen into the apparatus; or the apparatus has been exposed to rain or moisture, does not operate normally, or has been dropped.
15. No naked flame sources, such as candles, should be placed on the apparatus.

WARNING:
TO REDUCE THE RISK OF FIRE OR ELECTRIC SHOCK, DO NOT EXPOSE THIS APPLIANCE TO RAIN OR MOISTURE.



FCC information for **MOON 780D v2** Digital-to-Analog Converter equipped with the **Qualcomm® aptX™ audio for Bluetooth** module and **MiND 2** Music Streamer module::

This unit contains Transmitter Module FCC ID : SSSBC127-X and Transmitter Module FCC ID: 2AJYB-S810. This device complies with part 15 of the FCC Rules. Operation is subject to the following two conditions: (1) This device may not cause harmful interference, and (2) this device must accept any interference received, including interference that may cause undesired operation.

Important Safety Instructions (cont'd)



The lightning flash with the arrowhead symbol, within an equilateral triangle, is intended to alert the user to the presence of uninsulated "dangerous voltage" within the product's enclosure that may be of sufficient magnitude to constitute a risk of electric shock to persons.



The exclamation point within an equilateral triangle is intended to alert the user to the presence of important operating and maintenance (servicing) instructions in the literature accompanying the appliance.



Marking by the "CE" symbol (shown left) indicates compliance of this device with the EMC (Electromagnetic Compatibility) and LVD (Low Voltage Directive) standards of the European Community

Please read all instructions and precautions carefully and completely before operating your MOON 780D v2 Reference DAC.

1. **ALWAYS** disconnect your entire system from the AC mains before connecting or disconnecting any cables, or when cleaning any component. To completely disconnect this apparatus from the AC mains, disconnect the power supply cord plug from the AC receptacle.
2. The unit must be terminated with a three-conductor AC mains power cord which includes an earth ground connection. To prevent shock hazard, all three connections must **ALWAYS** be used. Connect the unit only to an AC source of the proper voltage; both the shipping box and rear panel serial number label will indicate the correct voltage. Use of any other voltage will likely damage the unit and void the warranty
3. AC extension cords are **NOT** recommended for use with this product. The mains plug of the power supply cord shall remain readily accessible.
4. **NEVER** use flammable or combustible chemicals for cleaning audio components.
5. **NEVER** operate the unit with any covers removed. There are no user-serviceable parts inside. An open unit, especially if it is still connected to an AC source, presents a potentially lethal shock hazard. Refer all questions to authorized service personnel only.
6. **NEVER** wet the inside of the unit with any liquid. If a liquid substance does enter your unit, immediately disconnect it from the AC mains and take it to your MOON dealer for a complete check-up.
7. **NEVER** spill or pour liquids directly onto the unit.
8. **NEVER** block air flow through ventilation slots or heatsinks.
9. **NEVER** bypass any fuse.
10. **NEVER** replace any fuse with a value or type other than those specified
11. **NEVER** attempt to repair the unit. If a problem occurs contact your MOON dealer.
12. **NEVER** expose the unit to extremely high or low temperatures.
13. **NEVER** operate the unit in an explosive atmosphere.
14. **ALWAYS** keep electrical equipment out of reach of children.
15. **ALWAYS** unplug sensitive electronic equipment during lightning storms.
16. **WARNING:** Do not expose batteries or battery pack to excessive heat such as sunshine, or fire or the like.

Table of Contents

Introduction	6
Unpacking	7
Installation & Placement	7
Front Panel Controls	8
Software Setup	9
Rear Panel Connections	14
SimLink™	15
Operating the 780D v2	15
Remote Control Operation	16
Balanced Operation	18
Specifications	19
Quick Reference: Setup Menus	Appendix

www.simaudio.com

Simaudio Ltd., 1345 Newton Road
Boucherville, Québec J4B 5H2 CANADA

Date Code: 20181022

Introduction

Thank you for selecting the **MOON 780D v2** Reference Digital-to-Analog Converter (DAC) as a part of your music system. This DAC has been designed to offer state-of-the-art high-end performance in an elegant package, while retaining all the sonic hallmarks on which Simaudio has made its reputation. We have spared no effort to ensure that it is the finest DAC available. We have been building high-performance audio equipment for 35 years, and the know-how gained through our cumulative experience is an important reason why **MOON** DACs are so musically satisfying.

With MiND 2, the **MOON 780D v2** is a Roon Ready device, which means it can also be used with Roon software. As soon as the network setup (Ethernet or WiFi) is completed, Roon system can be used to control the unit. Please consult Roon (<https://roonlabs.com/>) for more information on the Roon software usage and installation.

With MiND 2, the **MOON 780D v2** includes MQA technology, which enables you to play back MQA audio files and streams, delivering the sound of the original master recording. It is manufactured under licence from MQA Limited. For more information on MQA please consult : <http://www.mqa.co.uk/>.

The performance of your **780D v2** will continue to improve during the first 400 hours of listening. This is the result of a "break-in" period required for the numerous high quality electronic parts used throughout this DAC.

Before setting up your new **MOON 780D v2**, we encourage you to please read this manual thoroughly to properly acquaint yourself with its features. We hope you enjoy listening to the **MOON 780D v2** DAC as much as the pride we have taken in creating this fine audio product. We understand the power and emotion of music and build our products with the goal of faithfully capturing these elusive qualities.

The information contained in this manual is subject to change without notice. The most current version of this manual is available on our official website at www.simaudio.com

Your **MOON 780D v2** DAC incorporates many innovative significant design features to achieve its "world class" level of performance. This is an abbreviated list of the more important features:

Nine (9) digital inputs include USB (hi-res audio), AES/EBU, SPDIF (x3), Optical (x2), Bluetooth® with Qualcomm® aptX™ audio support, and Ethernet/Wi-Fi.

Supports native DSD up to **DSD256** and PCM up to **384kHz** (USB and network only).

Built-in **MiND 2** network streaming player.

DSD Streaming over Ethernet via MiND.

Femto second clock (vs. Pico second clock where 1 pico-second = 1000 femto-seconds): The result is much lower jitter - 150 femto-seconds (less than 1/6 of a pico-second) - and therefore lower distortion.

There is one DAC chip per channel running in mono mode for a true dual-mono design; each of these two DAC chips are programmed to process a single channel for the best possible sonic performance, whereby each chip contains 16 individual DAC circuits which provides for 8 differential mode DAC circuits.

On-board programmable software for customization of the end-user interface.

MHP (Moon Hybrid Power) is a "High Performance Universal (Power Supply)" using conductive polymer capacitors, high speed digital switching and analog linear regulators post stages (non-switch mode) for ultra stable and exceptionally low noise DC output

2 stages of our **M-LoVo** (MOON Low Voltage) DC regulation circuit; a highly sophisticated circuit that is virtually free of noise, yielding an exceptionally fast, precise, and stable DC voltage. The result is a power supply with a virtually unmeasurable noise floor

Power supply voltage regulation includes **i²DCf** (Independent Inductive DC Filtering); There is one inductor dedicated to each integrated circuit type component (DAC, Op-Amp, etc.) in the audio circuit's signal path; 4 stages in all

A very short capacitor-free signal path using a DC servo circuit and proprietary 18dB/octave analog filter

RS-232 port for (i) full unsolicited bidirectional feedback and (ii) firmware updates; **12 Volt trigger** output for remote operation; **IR input** for external control with aftermarket infrared remote control receivers and **SimLink™** controller ports that allow for 2-way communications between other MOON components.

Ultra rigid chassis construction to minimize the effects of external vibrations.

Fully compatible with the **820S** external power supply.

Unpacking

The **780D v2** should be removed from its box with care.

The following accessories should be included inside the box with your Digital-to-Analog Converter:

- ✓ AC power cable
- ✓ FRM-3 remote control with three 'AAA' batteries
- ✓ 'SimLink™' cable with 1/8" mini plug terminations on each end
- ✓ Two (2) Wi-Fi antenna
- ✓ This owner's manual
- ✓ Warranty and product registration information (USA and Canada only)

Once the **780D v2** is unpacked, inspect it thoroughly and report any damage to your dealer immediately. We suggest that you keep all of the original packaging, storing it in a safe, dry place in case you're required to transport this product. The customized packaging is specially designed to protect the **780D v2** from any potential damage during transit.

Please write the serial number of your new **780D v2** in the space provided below for future reference.

Serial Number

Installation & Placement

The **MOON 780D v2** DAC should be placed on a solid, level surface. You should avoid placing it near a heat source or inside a closed cabinet that is not well ventilated as this could compromise the DAC's performance and reliability.

If the surface you have chosen isn't perfectly level, each of the four (4) legs of your **780D v2** are height adjustable; carefully using your fingers, you can either raise each leg by turning the cone underneath clockwise, or lower each leg by turning it counterclockwise.

We strongly recommend that you leave these cones mounted to the component at all times for reasons related to both performance and aesthetics.

Since your 780D v2 is equipped with the "MiND 2" Music Streamer, please visit our website to view videos on setup and usage of the application.

If you intend to use the 780D v2's USB input connection (PCM or DSD) with a Windows-based computer, you will need to install our driver, which can be downloaded from the Guides & Downloads section, under Support tab on simaudio.com.

Note: Apple-based computers don't require this driver.

Front Panel Controls

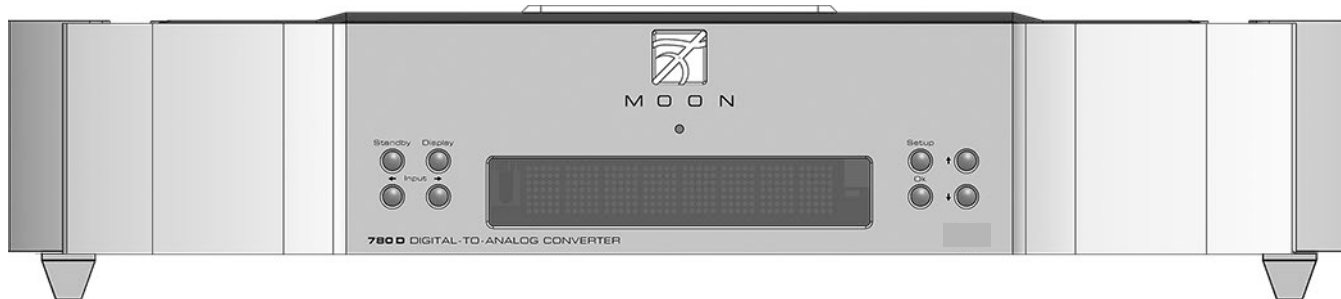

Figure 1: 780D v2 Front panel

The front panel will look similar to Figure 1 (above). The large digital display window indicates the selected digital input ("D1" thru "D9") its corresponding sampling rate frequency in kHz ("44.1" thru "384.0") of the source material currently being played and/or assigned input label. The "Standby" button disengages all outputs from the rest of the **780D v2's** circuitry and turns off the digital display. However, when in "Standby" mode, all digital and analog audio circuitry remains powered up to help maintain optimal performance. When switching back from "Standby" to the "on" mode, the selected 'input' will be memorized from the previous listening session. The blue indicator LED turns off when the **780D v2** is in "Standby" mode.

The "Display" button allows you to adjust the brightness of the large digital display window. It also provides you with the option of turning off the display. There are three (3) different levels of brightness; The default is medium. Pressing the "Display" button once will increase the level to the highest setting. Pressing the button again will decrease the brightness to the lowest setting. Pressing the "Display" button a third time returns the display to its default setting of medium. To turn the display off, press and hold the "Display" button for 2 seconds. When the display is turned off, it will still come back on briefly whenever you press any of the buttons located on the front panel or the remote control, using the brightness level that was previously set; the display will automatically turn off again once you are done. To turn the display back on, simply press and hold the "Display" button for 2 seconds.

The two (2) buttons labeled "◀ Input ▶" allow you to sequentially scroll, either forward "▶" or backward "◀" through all the digital inputs. The inputs are ordered as follows going forward: "D1", "D2", "D3", "D4", "D5", "D6", "D7", "D8" and "D9". When you change inputs, the display window will show the new digital input and briefly four (4) dashes "----". These dashes indicate that

the **780D v2** is in the process of locking onto a digital signal – this may take several seconds. Once the **780D v2** successfully locks onto the digital signal, the four dashes will be replaced by either the sampling rate frequency of this digital signal or the assigned label for this input (refer to the next section "Software Setup" for further details). When the selected digital input signal cannot be locked onto, "----" remains in the display window. The **780D v2** is capable of processing a PCM digital signal at one of the following eight (8) different sampling rates: "44.1", "48.0", "88.2", "96.0", "176.4", "192.0", "352.8" and "384.0" (all in kHz) or a DSD digital signal at one of the following three (3) data rates DSD64 (2.82MHz), DSD128 (5.64MHz) and DSD256 (11.28MHz); For DSD input signals, the corresponding information will appear in the display window as "DSD", "DSD.2" and "DSD.4" for these data rates, respectively.

The "Setup" and "OK" buttons are used for programming the numerous software functions available on this DAC. The next section, entitled "Software Setup", explains their usage in detail. As well, the ▲ and ▼ buttons are used to navigate through the "Software Setup" menus.

Software Setup

The **MOON 780D v2** DAC includes powerful software that allows you to configure it to meet your specific needs. For each of the nine (9) inputs, you can assign a label to replace the factory assigned name (i.e. D1,D2, etc.) and disable the input completely when it's not in use. As well, you can (i) place the Bluetooth input into pairing mode, (ii) assign a SimLink™ connected MOON CD Player to the D1 through D4 inputs that will cause the 780D v2 to automatically switch to the assigned input when pressing the PLAY button on the CD player, (iii) change what appears in the on-screen display (OSD),(iv) invert the phase of the audio signal by 180 degrees, (v) disable the front panel infrared sensor and (vi) change the IR code set for use with a universal remote control. Finally, there's a facility to reset all software settings back to their factory defaults.

Please refer to the accompanying quick reference diagram for a snapshot of the entire Setup menu layout.

When you are in Setup mode, there are four (4) front panel items used to program this DAC; The "Setup" button for navigating up and down through the various menu levels, the ▲ and ▼ buttons for scrolling through the available choices within each programmable item, and the "OK" button for confirming and saving your selections.

What follows are step-by-step examples of how to configure an input, pair a Bluetooth enabled smart device, change the contents of the on-screen display, invert phase of the audio signal, setup the unit for an aftermarket Infrared remote receiver and reset the software back to the factory default. We will begin by walking through the available options for the "D1" input:

1. To enter the Setup mode, begin by pressing the "Setup" button; "SETUP" will appear in the display window.
2. Press either the ▲ or ▼ button until "INPUTS" appears in the display. "Press the "OK" button..
3. Press either the ▲ or ▼ button until "D1" appears in the display. Press "OK".
4. "LABEL" will appear in the display. Press "OK".
5. "DVD" will appear in the display. Press either the ▲ or ▼ button to scroll through more than a dozen choices appearing in alphabetical order (DVD ... CD ... BLU-RAY, etc.), various MOON source model names (i.e. ANDROMEDA ... 780D v2, etc) and finally a choice called "CUSTOM" which allows you to create your own text label of up to 8 characters in length (refer to the example at the end of this section for more details).
6. When the label name you wish to assign to the D1 input appears in the display, press the "OK" button. "SAVED" will briefly appear in the display followed by "LABEL".
7. Press the "Setup" button and the label you've just assigned to the D1 input will appear in the display.
8. At this point you can (i) continue configuring one other option for the D1 input (see the next step), (ii) configure another input such as D2 (Press either the ▲ or ▼ button to access the D2 input), or (iii) leave the Setup mode (press the "Setup" button once and "INPUTS" appears in the display; then press it again and "EXITING" will appear in the display).
9. The only other configurable option for the D1 input (and other inputs, except for the D8 MiND input) is to disable it when that input won't be used. press either the ▲ or ▼ button and "ENABLE" will appear in the display. Press "OK".
10. The factory default is "ENABLE Y" which will appear in the display. Press either the ▲ or ▼ button to alternate between "ENABLE N" and "ENABLE Y". Press "OK" and "SAVED" will briefly appear in the display followed by "ENABLE". When an input has been disabled it will appear only in the Setup menu as "D1 N/A".
11. You have now passed through both configuration options for the D1 input. At this point, you can (i) repeat the above process for the another input by pressing the "Setup" button and then using either the ▲ or ▼ button to select the next input to configure, (ii) exit from the Setup procedure by

pressing the "Setup" button three times or (iii) continue with the Setup procedure by pairing a Bluetooth device, assigning a MOON CD player to certain digital inputs, configuring the On-Screen Display (OSD), inverting the phase of the audio signal by 180 degrees, disabling the infrared remote sensor, changing the IR codes, or resetting the **780D v2** back to factory default status (see the following examples).

Unlike the D1 through D6 inputs which can operate with any PCM digital input signal up to, and including, 24-bit/192kHz, the USB input, labelled D7 on the rear panel, is designated specifically for both DSD and PCM signals up to 32-bit/384kHz (including DXD); The default OSD label is "USB". As well, the D8 input is reserved for the included MiND 2 network streaming module and the D9 input is reserved for the wireless Bluetooth input; The default labels are "MiND" and BLTOOTH, respectively. For these three (3) inputs, you may change the assigned label that appears in the OSD by using the aforementioned on-board setup software. As well, you can also disable these inputs (except for the D8 MiND) if you don't plan to use them and enable them again in the future when necessary.

The D8 MiND input has a second additional setup option called "STATUS" which, when enabled, will show the status of the current track that is being played from the MiND's queue; specifically ► or II along with the elapsed time of the current track. To enable this feature, you will need to do the following:

1. Enter the Setup mode by pressing the "Setup" button; "SETUP" will appear in the display window.
2. Press either the ▲ or ▼ button until "INPUTS" appears in the display. Press the "OK" button.
3. Press either the ▲ or ▼ button until "D8" appears in the display. Press "OK".
4. Press either the ▲ or ▼ button until "STATUS" appears in the display. Press "OK".
5. "STATUS Y" will appear in the display.
6. Press the "OK" button and "SAVED" will appear in the display, followed by "STATUS".

7. Press the "SETUP" button three (3) times to exit from the Setup menu.
8. To disable this feature, repeat steps 1 through 4, then press either the ▲ or ▼ button until "STATUS N" appears in the display, then repeat steps 6 and 7.

Assigning a custom label to an input:

1. Using the first example from this section for configuring an input, repeat steps 1 through 5.
2. When "CUSTOM" appears in the display press the "OK" button. The display will show ".....".
3. Press either the ▲ or ▼ button to scroll through the 26 letters of the English alphabet, first in uppercase and then lowercase, followed by the numbers 0 through 9, and finally several miscellaneous symbols including the space character. When you see the letter, number or symbol you wish to use, press "OK" to select it and then repeat this step for the next character.
4. You must assign all 8 characters when creating a custom input label; If your label requires only 5 characters, you will need to input a blank space for the remaining 3 characters.
5. Once you've filled the last position, press "OK" and "SAVED" will briefly appear in the display followed by "INPUTS".
6. Press the "SETUP" button to exit from the Setup menu.

When you want to use the **780D v2's** D9 input with a Bluetooth capable smart device (iPhone, iPad, Android, etc.), you must first pair this device to the **780D v2** by temporarily placing the **780D v2** in discovery mode as follows:

1. Enter the Setup mode by pressing the "Setup" button; "SETUP" will appear in the display window. press "OK".
2. Press either the ▲ or ▼ button until "BLTOOTH" appears in the display. press "OK".

3. "Pair ? Y" will appear in the display. press "OK".
4. Now the **780D v2** will be in Bluetooth discovery mode, and will remain so for 30 seconds; "PAIRING..." will appear in the display window, and the three "." will flash in sequence.
5. "MOON 780D v2..." will appear in the Bluetooth device list of your smart device and you must select it. At the same time, the 780D v2's display window will show "PAIRED" for several seconds, and then "BLTOOTH" to indicate successful pairing. **The Bluetooth feature of your smart device must be enabled for pairing to work.** This procedure only needs to be performed once for each smart device.
6. When the Bluetooth pairing procedure fails after 30 seconds, "TIMEOUT" will briefly appear in the display window, followed by "BLTOOTH" after a few seconds.
7. To exit the discovery mode prematurely, press the setup button and "ABORTED" will briefly appear in the display, followed by "BLTOOTH".
8. Press the "SETUP" button once to exit u and "EXITING" will appear briefly in the display window.

Your **MOON 780D v2** can automatically switch to the designated input for your SimLink™ connected MOON CD Player or CD transport when you press its play ► button; You must first assign the corresponding digital input on the **780D v2**. The factory default input is D2. To change the default input from D2 to either D1, D3 or D4, you must do as follows:

1. Enter the Setup mode by pressing the "Setup" button; "SETUP" will appear in the display window.
2. Press either the ▲ or ▼ button until "MOON CD" appears in the display. press "OK".
3. Press either the ▲ or ▼ button until the digital input you wish to assign to you MOON CD Player or CD transport appears in the display window. For example, if you wanted to assign the D3 input for your MOON CD Player or CD transport then you would continue scrolling until "CD : D3" appears in the display. Then press "OK".

4. Press the "Setup" button once to exit and "EXITING" will appear in the display window.

You can change the information that appears in the **MOON 780D v2's** display window during normal operation for all inputs. This is referred to here as the On-Screen Display (OSD):

1. Enter the Setup mode by pressing the "Setup" button; "SETUP" will appear in the display window.
2. Press either the ▲ or ▼ button until "OSD" appears in the display. Press "OK".
3. 'S. RATE" will appear in the display window. This option will display the actual input (D1, D2, D3, etc) along with the sampling rate frequency of the track that is currently playing. Pressing either the ▲ or ▼ button will reveal the other available OSD option "IN.LABEL" which will show the actual input along with the label you previously assigned to each input in the display window.
4. Once you have determined your preferred OSD option, press "OK" and "SAVED" will briefly appear in the display followed by "OSD".
5. Press the "SETUP" button to exit from the Setup menu.

note: When the "In.Label" option is selected, the sampling rate frequency will be appear in the display window for 2 seconds when you change the input.

You can invert the phase of the **MOON 780D v2's** output signal by 180 degrees for all inputs as follows:

1. Enter the Setup mode by pressing the "Setup" button; "SETUP" will appear in the display window.
2. Press either the ▲ or ▼ button until "PHASE" appears in the display. Press "OK".
3. "NORMAL" will appear in the display.
4. Press either the ▲ or ▼ button and "INVERTED" will appear in the display. Press "OK" and "SAVED" will briefly appear in the display window followed by

"PHASE". To switch back to the "NORMAL" phase setting, repeat this process and select "NORMAL".

5. Press the "SETUP" button to exit from the Setup menu.

If you want to control the **MOON 780D v2** using a wired aftermarket infrared remote control receiver with a universal remote control, you can disable the IR sensor located on the front panel as follows:

1. You may either continue where we left off in the previous example by returning to the main menu and then pressing either the ▲ or ▼ button until "INFRARED" appears in the display OR enter into the "Setup" mode from the beginning by pressing the "Setup" button and pressing either the ▲ or ▼ button until "INFRARED" appears in the display.
2. Press "OK" and "NORMAL" will appear in the display.
3. To disable the **MOON 780D v2's** front panel IR sensor, press either the ▲ or ▼ button to alternate from "NORMAL" to "DISABLED".
4. Press "OK" and "SAVED" will appear briefly in the display followed by "INFRARED"
5. Press the "Setup" button to exit from the Setup menu.

The **MOON 780D v2** is equipped with a rear mounted IR input for use with aftermarket wired infrared remote control receivers. In the event that you want control the **MOON 780D v2** with a universal remote control and **NOT** the one included (FRM-3), you can change the RC-5 remote control system codes. This procedure is recommended when you have a large custom install setup that uses multiple integrated amplifiers and/or preamplifiers that operate on the RC-5 standard and you need to make each component unique w.r.t. remote control operation – up to 4 components. Before making the following change, you should have a basic understanding of how to program a universal remote control. The following example shows how to change the IR codes that the **MOON 780D v2** will recognize:

1. You may either continue where we left off in the previous example by returning to the main menu and then pressing either the ▲ or ▼ button until "IR

CODE" appears in the display OR enter into the "Setup" mode from the beginning by pressing the "Setup" button and then pressing either the ▲ or ▼ button until "IR CODE" appears in the display.

2. Press "OK" and "DEFAULT" will appear in the display.
3. To change the RC-5 system codes, press either the ▲ or ▼ button to scroll through the available sets of RC-5 compatible codes: "SYS11", "SYS14", "SYS15", and "SYS19".
4. Once you've decided on one, Press "OK" and "SAVED" will appear briefly in the display followed by "IR CODE".
5. From this point you can (i) exit from the Setup procedure by pressing the "Setup" button again and "EXITING" will appear in the display or (ii) reset the **780D v2** back to factory default status (see the following example), or (iii) configure more inputs (examples on previous pages).

Reset the **MOON 780D v2** software settings back to their factory defaults:

1. Enter the Setup mode by pressing the "Setup" button; "SETUP" will appear in the display window. press "OK".
2. Press either the ▲ or ▼ button until "RESET" appears in the display. press "OK".
3. "RESET N" will appear in the display.
4. Press either the ▲ or ▼ button until "RESET Y" appears in the display.
5. Press "OK" and "SURE ? N" will appear in the display.
6. Press either the ▲ or ▼ and "SURE ? Y" will appear in the display.
7. Press "OK" and "SAVED" will briefly appear in the display followed by "RESET".
8. Press the "Setup" button again and "EXITING" will appear in the display.

Rear Panel Connections



Figure 2: 780D v2 Rear panel

The rear panel will look similar to Figure 2 (above). On the left side are two pairs of analog outputs labeled “Right” and “Left”, each with a single-ended RCA and balanced XLR connector. These are “Fixed Level” outputs, intended to be connected to a line-level input on either your preamplifier or integrated amplifier. We strongly recommend that you use the balanced XLR connectors on your **780D v2** to maximize its level of performance. Don’t hesitate to use high quality interconnect cables*. Poor quality interconnect cables can degrade the overall sonic performance of your system.

To the right of the analog outputs, is a group of seven (7) “Digital Inputs” labelled “D1” thru “D7”. Input “D1” is an AES/EBU on 3-pin XLR connectors and it will benefit most from cables with an impedance of 110Ω. Inputs “D2”, “D3” and “D4” are S/PDIF – the first two on RCA connectors and the third on a BNC connector, benefitting most from cables with an impedance of 75Ω. Inputs “D5” and “D6” are Optical and use a Toslink connector. Don’t hesitate to use high quality digital interconnect cables*.

The space directly above the row of digital inputs is reserved for the “MiND 2” Music Streamer; you will see a socket for a WiFi antenna and an RJ45 ethernet connector socket. This is the eighth digital input. Please consult the “MiND Setup Guide” and “MiND User Guide” for further details.

Note: The ninth digital input is wireless aptX Bluetooth, and therefore doesn’t require an input connector.

The upper right side of the rear panel has various connectors for external communications. First there’s a 12V trigger output on a 1/8” mini-jack. Then there is a 1/8” mini-jack input for use with aftermarket infrared remote control receivers. Next are two (2) “SimLink™” connectors labeled “in” and “out” on 1/8” mini jacks. Please refer to the next section entitled SimLink™ for

more details. Finally, the **780D v2** is equipped with full-function bi-directional RS-232 port control and status for custom integration or automation, as well as future software updates.

Directly below these communications interfaces, are a pair of connectors labeled “Ext. Supply Input”: “Input 1” (4-pin XLR) and “Input 2” (5-pin XLR). These are reserved for use with MOON 820S external power supply.

On the far right side is the main power switch (“0”=off, “1”=on), the IEC receptacle, labeled “AC Input” for the included AC power cord. Connect the supplied AC power cable to the IEC receptacle. Ensure that the AC wall outlet you use has a functioning ground. For the best sonic performance, it is preferable that you plug your **780D v2** directly into a dedicated AC outlet and avoid using an extension cord.

* Please speak with your MOON Authorized Retailer about the benefits of high quality cables for your system, and superior quality AC wall outlet.

SimLink™

One of the main features of SimLink™ on the **780D v2**, involves the "Standby" function. By pressing down and holding the "Standby" button for 2 seconds on the **780D v2**, all other **MOON** components connected via the SimLink will go into "Standby" mode along with the **780D v2**. The same logic applies when switching from "Standby" to active mode. However, since your **780D v2** is equipped with the "MiND 2" Music Streamer, the SimLink™ offers many more features: Volume, Mute, Standby, Digital Input Selection all via the "MiND" app running on your Apple device.

If you are using a MOON CD Transport or CD Player with your **780D v2** you should make a SimLink™ connection between the "CD"s SimLink™ out and the **780D v2**'s SimLink™ in. The default CD input is the "D1" which means that when you press the ► (play) button on the CD, the **780D v2** will automatically switch to the "D1" input. You can change the default for the "CD" using the "MOON CD" setting previously described in the "Software Setup" section.

The connection rules for the SimLink™ are very straightforward. You must always connect the supplied cable between one component's "SimLink™ Out" jack and another component's "SimLink™ In" jack. Also, there is no master component in a SimLink™ chain; no one particular component operates as the main communications controller.

*If you are using your **780D v2** with an older MOON product such as a P-7, P-8 or i-7, you will need to update the software of the older product to allow for complete SimLink™ functionality. Contact your retailer for further details.*

Operating the 780D v2

We recommend leaving your **780D v2** powered up at all times to maintain optimal performance. When you plan on being away for a few days, it may not be a bad idea to power off your DAC. Please keep in mind that once fully "broken-in", your **780D v2** requires several hours of operation before reaching optimal performance after powering it up again.

Turning on your 780D v2 for the first time

Prior to turning the DAC on for the first time, make sure that every cable is properly connected to avoid any problems. Flick the main rocker switch, located on the rear panel, labeled "POWER" to the '1' (on) position. Next, briefly press the push button labeled "Standby" located on the front panel. You will hear a very faint click sound confirming that everything is in order. The blue LED on the front panel will illuminate, indicating that the **780D v2** is now powered up and ready for use.

On and Off Sequence

To avoid having any annoying noises (ie. "thumps" and "pops") emanate from your speakers when powering your **780D v2** on or off, you should always power up your **780D v2** before powering up your preamplifier and/or, integrated amplifier. As well, always power down your **780D v2** after powering down your preamplifier, and/or integrated amplifier.

Remote Control Operation



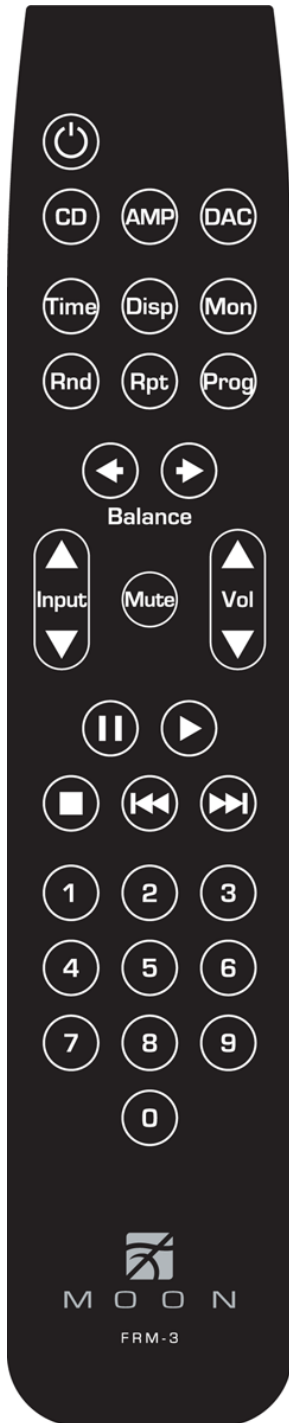

The **MOON 780D v2** uses the '**FRM-3**' full function, all aluminum backlit remote control (figure 3). It operates on the Philips RC-5 communication protocol and can be used with other MOON components such as CD Players, DAC's, Integrated Amplifiers, as well as other Preamplifiers. The '**FRM-3**' remote uses three AAA batteries (included). To install them, use a Phillips head screwdriver #1 to remove the three screws located on the rear plate; insert the batteries in the correct direction and then screw the rear plate back into place.

To operate the **780D v2** with the '**FRM-3**', you must press the **DAC** button on the second row.

The  power button switches the **780D v2** between 'Standby' and 'On' mode.



Remote Control

Time	* Alternates the display window contents between currently playing track's elapsed time and the OSD settings defined in the Software Setup. <u>Note:</u> The D8 MiND input must have its STATUS set to "STATUS Y" for this to function to work (pg. 10).
Disp	Adjusts the display window's brightness by scrolling through the 3 different brightness levels: Low, Medium (Default) and High. To turn off the display, press and hold for 2 seconds - repeat to turn the display back on.
Rnd	* Plays the tracks in the MiND QUEUE in a random order instead of the order as they appear in the QUEUE. The display will show "RND ON" when activated and "RND OFF" when deactivated.
Rpt	* Press once and the entire MiND QUEUE will play again once it has reached the end; The display will show "RPT ALL". Press a second time and the current track in the QUEUE will play again once it has ended; The display will show "RPT 1". Press a third time to cancel the repeat mode; The display will show "RPT OFF".
Mute	Mutes the analog output signal. The display will show "MUTE". Pressing "Mute" again will reinstate the analog output signals.
II	* Pause the track currently playing in the MiND QUEUE.
	* From the <u>paused position</u> , resumes playback of the paused track in the MiND QUEUE or from the <u>stopped position</u> begins playback from the beginning of the MiND QUEUE.
	* Stop the track currently playing in the MiND QUEUE and resets position to the beginning of the QUEUE.
	* Go back to previous track in the MiND QUEUE.
	* Skip forward to next track in the MiND QUEUE.

The **Input ▲** and **Input ▼** buttons performing the same function as the **Input ◀** and **Input ▶** buttons located on the **780D v2**'s front panel.

* Denotes remote functions available ONLY for the D8 MiND input.

Figure 3: FRM-3

Backlight Function

Your **FRM-3** features a backlight capability that allows you to effortlessly operate this remote control in a darkened environment. Since battery lifespan is substantially reduced when the backlighting feature is activated, the **FRM-3** includes 3 different operational modes to help preserve battery life:

Default Mode (#1): The backlight is triggered on by either moving the remote control (via an internal motion detector) or by pressing any button on the remote's keypad; The backlight will remain illuminated for a full five (5) seconds after the last event (motion or pressed button). To activate the "Default Mode", press and hold the "CD" button for three (3) seconds. The backlight will illuminate once, very briefly for confirmation.

Button Mode (#2): The backlight is triggered ONLY by pressing any button on the remote's keypad - the internal motion detector is deactivated; The backlight will remain illuminated for a full five (5) seconds after the last button is pressed. To activate the "Button Mode", press and hold the "AMP" button for three (3) seconds. The backlight will illuminate twice, very briefly for confirmation.

Off Mode (#3): The backlight feature is completely disabled. To activate the "Off Mode", press and hold the "DAC" button for three (3) seconds. The backlight will illuminate three times, very briefly for confirmation.

Remote operation with a paired Bluetooth Device

Depending on the make and model of the smart device that you have paired to the **MOON 780D v2's** D9 BLTOOTH input, you may have the following "transport control" functions available to control the music stored on your smart device:

- Play a track on your smart device
- Pause current track
- Stop playing current track
- Advance to Next Track
- Go back to Previous Track

Remote operation with multiple MOON components

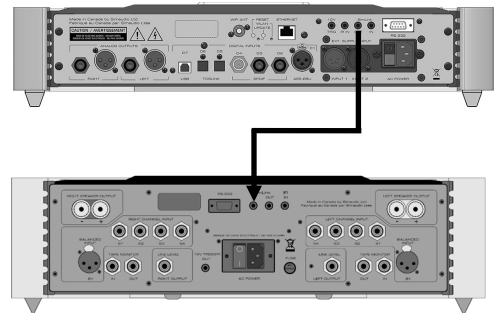

Figure 4: Remote Operation with SimLink™

In figure 4 we have a **780D v2** connected to a **700i v2** Integrated Amplifier via their respective SimLink™ ports. When you launch the MiND App on your mobile device, the **780D v2** will turn on, as will the **700i v2**; The **700i v2** will automatically switch to its "MiND" assigned input, as described previously in the "Software Setup" section. To shut down the system, press "Off" for this ZONE in the MiND app.

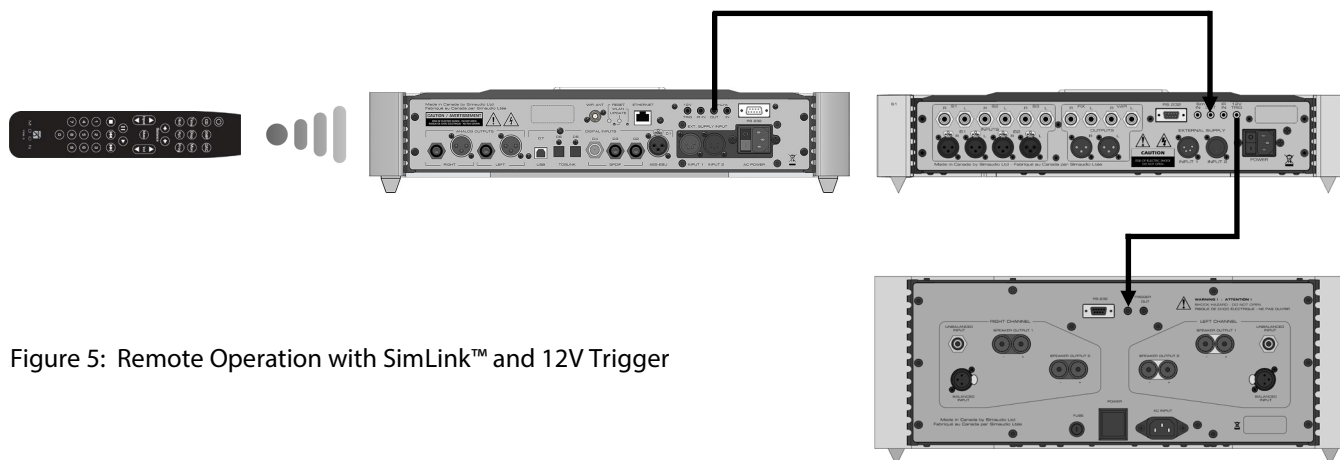

Figure 5: Remote Operation with SimLink™ and 12V Trigger

In figure 5 we have a **780D v2** DAC connected to a **740P** Preamplifier via their respective SimLink™ ports (using a 1/8" mini-jack cable), and the **740P** is connected to a **870A** Amplifier via their respective 12V triggers (also using a 1/8" mini-jack cable). When you turn on the **780D v2** via remote control (or its Standby button), both the **740P** and **870A** will turn on automatically. The same rule applies when you put the **780D v2** into Standby mode

Balanced Operation

When using an unbalanced interconnect, the audio signal runs through both the center wire and the shield/ground wire. Any noise picked up by this interconnect (ie. nearby magnetic fields such as an AC power cord) will be reproduced by both the preamplifier and amplifier, then heard through the loudspeakers. Conversely, a balanced interconnect has three separate conductors; one for the ground and two for the actual signal.

These two signals are identical except that one is 180 degrees out of phase with the other. For example, when one conductor is carrying a signal of +2 Volts, the other will be carrying a signal of -2 Volts. When these two inverted signals on a balanced line are output from the **MOON 780D v2**, any noise picked up by the interconnect will be eliminated since a differential circuit amplifies only the difference between these two signals: Noise on a balanced interconnect will be equal on both conductors and therefore cancel out.

Specifications

Configuration	Fully Balanced Differential
Digital Filter / Digital-to-Analog Converters	ESS ES9018S Sabre ³² 32-bit Hyperstream™ x 2
Frequency Response (full range)	2Hz - 100kHz +0/-3dB
THD @1kHz, 0dBFS (A-weighted)	0.0001%
Intermodulation Distortion	0.0001%
Dynamic Range	124dB
Signal-to-noise Ratio	124dB @ full output
Channel Separation	120dB
Intrinsic Jitter s	150 femto seconds RMS
Analog Outputs – Balanced / Single-Ended	1 pair XLR / 1 pair RCA
Analog Output @ 0dBFS - XLR / RCA	2.0 Volts
Analog Output Impedance - XLR / RCA	100Ω
DSD Sample Rates	DSD 64, DSD 128 & DSD256
PCM Bit-depth range	16 - 32 bits
PCM Sampling Frequency Rates	44.1 - 384kHz (352.8 & 384kHz)
Digital Inputs (9)	1 x AES/EBU, 3 x S/PDIF, 2 x TosLink, 1 x USB, MiND: 100Base-T RJ45 Ethernet & IEEE 802.11 b/g/n Wi-Fi and Bluetooth with Qualcomm® aptX™ audio support
Remote Control	Full-Function FRM-3
Power Consumption @ idle	22 watts
AC Power Requirements	100V – 240V / 50Hz - 60Hz
Shipping Weight	38 lb / 18 kg
Dimensions (W x H x D, inches / cm)	18.75 x 4.0 x 16.8 / 47.6 x 10.2 x 42.7

Balanced Pin Assignment:

Pin 1	Ground
Pin 2	Positive
Pin 3	Negative

Fuse Replacements: All versions uses a 1.0 A slow blow (5 x 20mm).

NOTE: If you require the RS-232 codes for your **780D v2**, please visit the "Contact Us" page and complete the "Information request" form on our website at www.simaudio.com.

Quick Reference: MOON 780D v2 Setup Menus

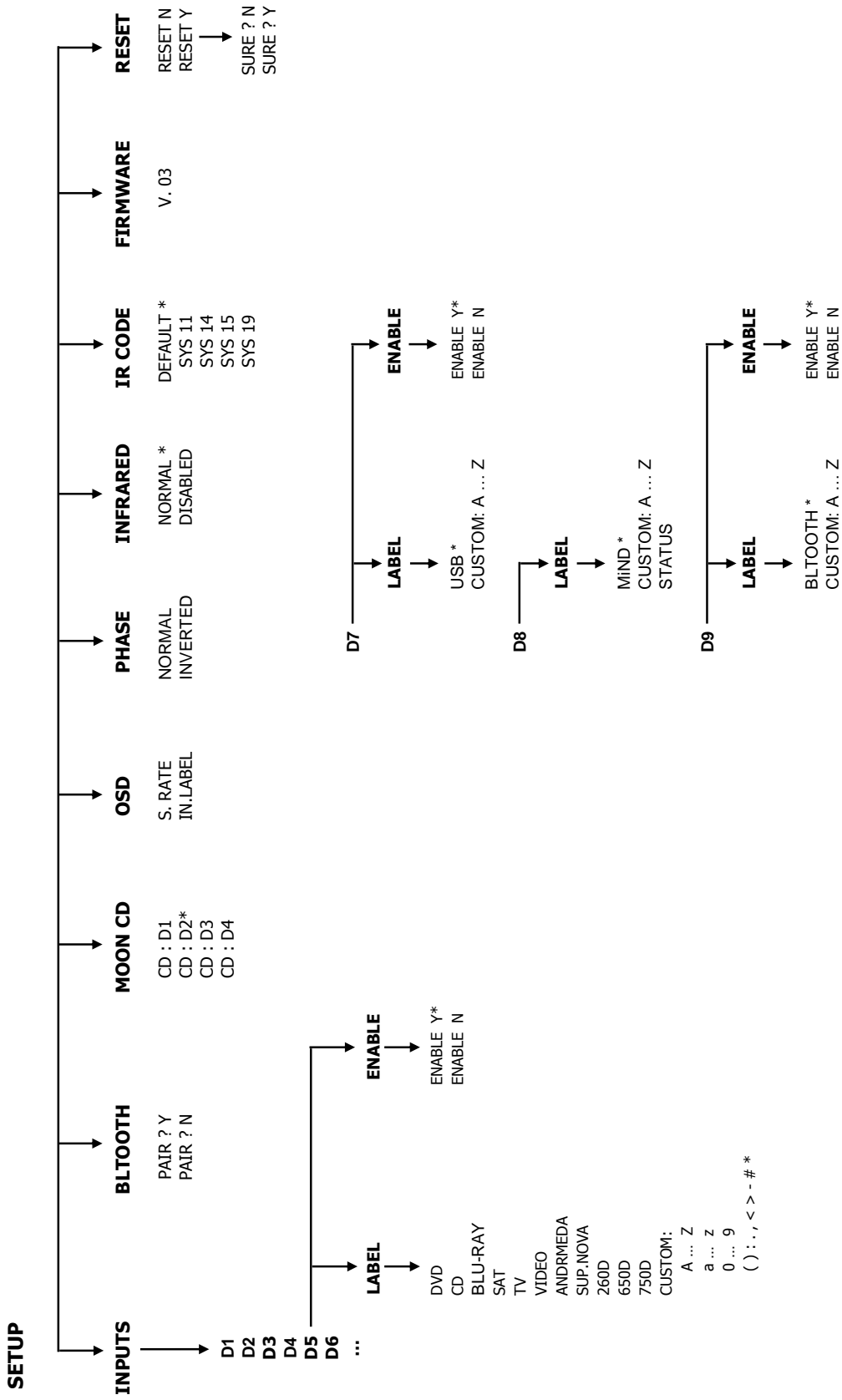

* Denotes factory default setting