

GOLD NOTE
il suono italiano

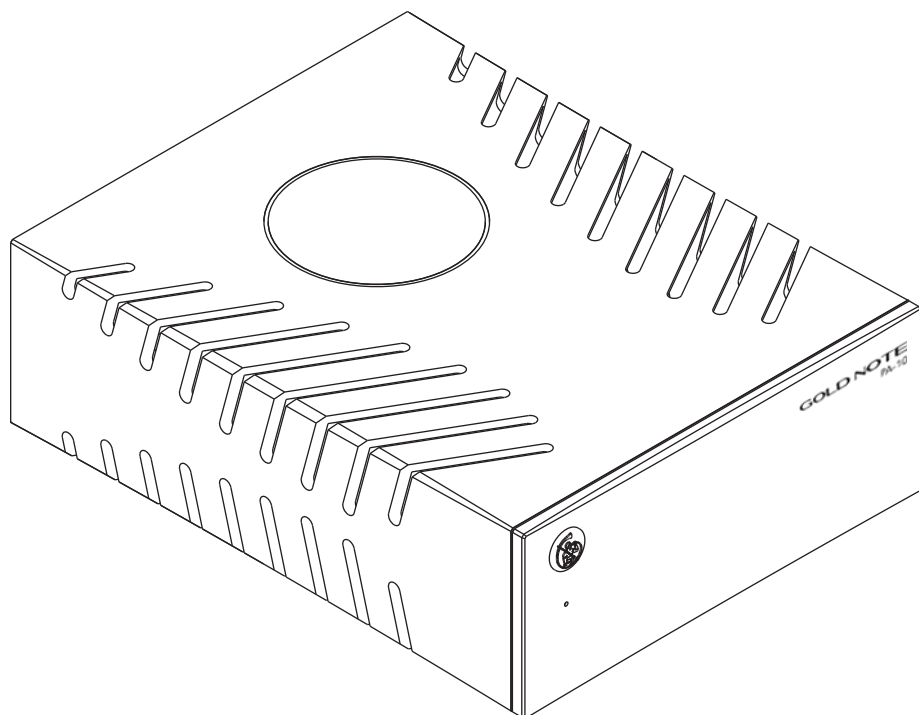

PA-10

STEREO POWER AMPLIFIER

USER MANUAL

INDEX

PACKAGE CONTENT.....	P. 3
DESCRIPTION.....	P. 4
TECHNICAL SPECIFICATIONS.....	P. 5
FRONT PANEL.....	P. 6
REAR PANEL.....	P. 7
PA-10 INSTALLING.....	P. 8
WARRANTY AND SERVICE.....	P. 14
TROUBLESHOOTING.....	P. 15
IMPORTANT SAFETY INFORMATION.....	P.16

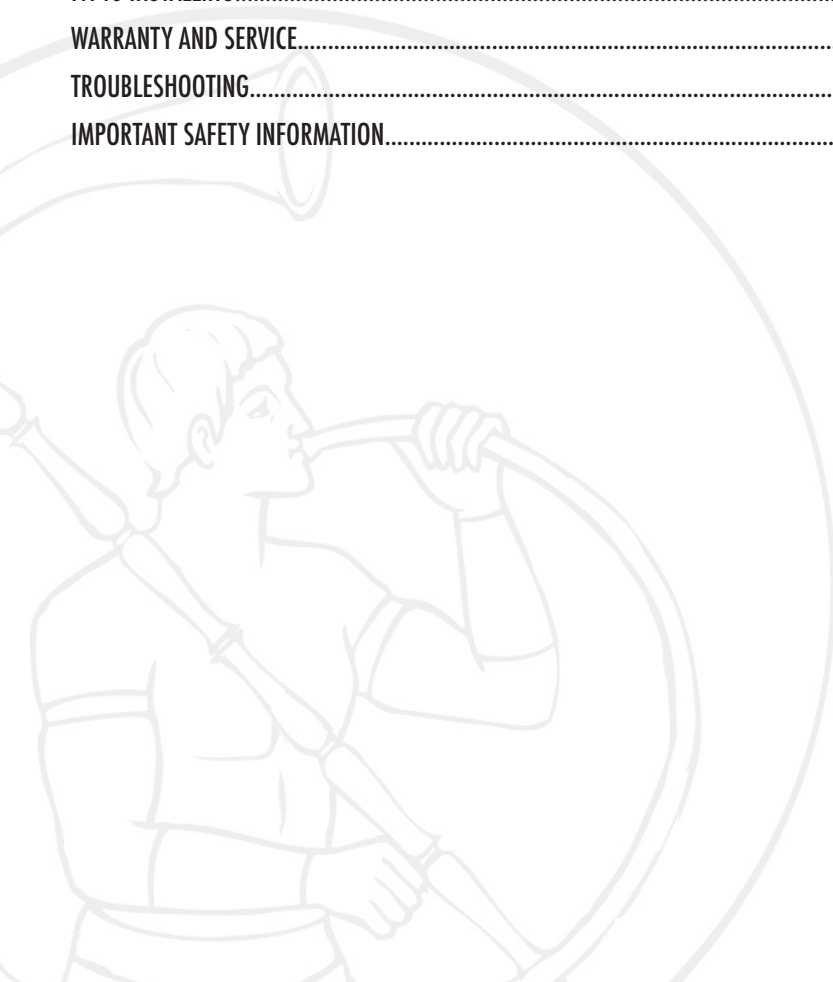

PACKAGE CONTENT

- PA-10
- 1 AC CABLE
- 1 GN Link Cable
- 1 User Manual

DESCRIPTION

The PA-10 is the new Power Amplifier of the Gold Note series 10 featuring a lot of innovations which have always distinguished Gold Note's designs. PA-10 has been developed to offer great power considering its small size. The product is designed as a perfect companion to the DS-10 4in1 DAC completing a conveniently sized High-End System without renouncing to the power and Gold Note sound quality.

The PA-10 is a fully balanced amplifier featuring a BTL design (Bridge-Tied-Load) which allows the unit to be easily bridged and work as a mono amplifier increasing its power rate from 75Watt per channel @ 8Ω stereo to a considerable 600Watt @ 4Ω mono. Using two PA-10 will increase the performance of your stereo system noticeably. The existing flexibility of the stereo power amplifier could even be largely extended with the mono application for all kind of speakers that require really high power and great energy.

Like the flagship model PA-1175 MKII, PA-10 features a unique adjustable Damping Factor design allowing for an ideal matching with any kind of loudspeakers: PA-10 can drive either large and difficult speakers (DF default setting) or high sensitivity and mini-monitor speakers (DF low activated on the rear).

The proprietary GN LINK technology allows putting the PA-10 into a Master-Slave-Mode with other sources like the DS-10 or a second PA-10. When connected via the GN Link cable, the unit will go in standby mode and will re-activate itself only when receiving a signal from the master unit. The GN Link-Function guarantees major user-friendliness since you will be switching ON/OFF the entire audio chain from one source only.

Top-level electronic components combined with outer connections RCA, XLR and gold plated speaker terminals complete the high-level build quality of the product. PA-10 is built around a very solid steel chassis completed by massive panels of aluminum to avoid RFI and EMI.

The aesthetic of the chassis is derived from the other series 10 products integrating the PA-10 seamlessly into a coherent concept that is inspired by the Italian design tradition.

Every Gold Note product is 100% proudly designed, manufactured and assembled in Italy

TECHNICAL SPECIFICATIONS

Power output: 75/150W @ 8/4Ω per ch. in stereo to 600W @ 4Ω per ch. in mono (BTL)
Frequency response: 10Hz-30kHz at +/-1dB
THD – Total Harmonic Distortion: 0,05%
Damping factor: selectable high/low

AUDIO INPUTS

Stereo RCA, stereo XLR balanced
Input sensitivity: 1,4V RMS on RCA and XLR
Input impedance: 13KΩ RCA/XLR

AUDIO OUTPUTS

Speaker terminals: Gold Plated Binding Posts

HIGH POWER AMP

The PA-10 is capable of:

2 x 75W @ 8Ω Stereo load

2 x 150W @ 4Ω Stereo load

2 x 300W @ 2Ω Stereo load

1 x 300W @ 8Ω Mono (BTL) load

1 x 600W @ 4Ω Mono (BTL) load

POWER

100-240V, 50/60Hz

Power consumption: <1W in standby

<10W no signal

150W at a 1/4 of nominal power, 1400W max

Fuse 6,3A T

DIMENSIONS AND WEIGHT

Dimensions: 200 W x 80 H x 260 D mm

Weight: Kg. 4 net - Kg. 5 boxed

FINISHES

Brushed Aluminum in Black, Silver or Gold

ADJUSTABLE DAMPING FACTOR

Adjustable GN property Damping Factor playing alternatively more difficult low sensitivity speakers or easy load and mini monitors.

GN LINK

The 3,5mm plugs GN LINK IN and GN LINK OUT are used to synchronize the PA-10 amplifier with other units with the same feature allowing a simultaneous switching ON/OFF (Master-Slave-Mode).

OPTIONAL ACCESSORIES

MX -10 card:

allows the simultaneous use of the RCA and XLR inputs increasing the product's versatility.

OPERATING CONDITION LIMITS

Temperature: from 0°C to 35°C

Humidity: 90% without condensation

FRONT PANEL

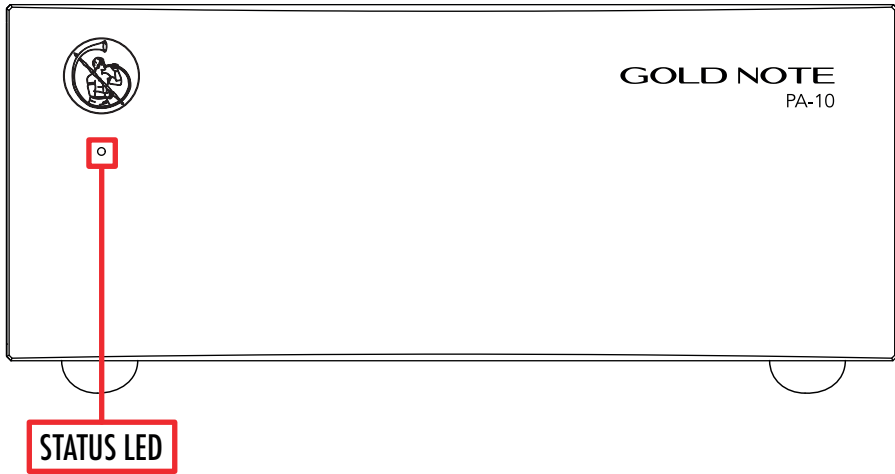

The status led turn blue when the PA-10 is powered.

REAR PANEL

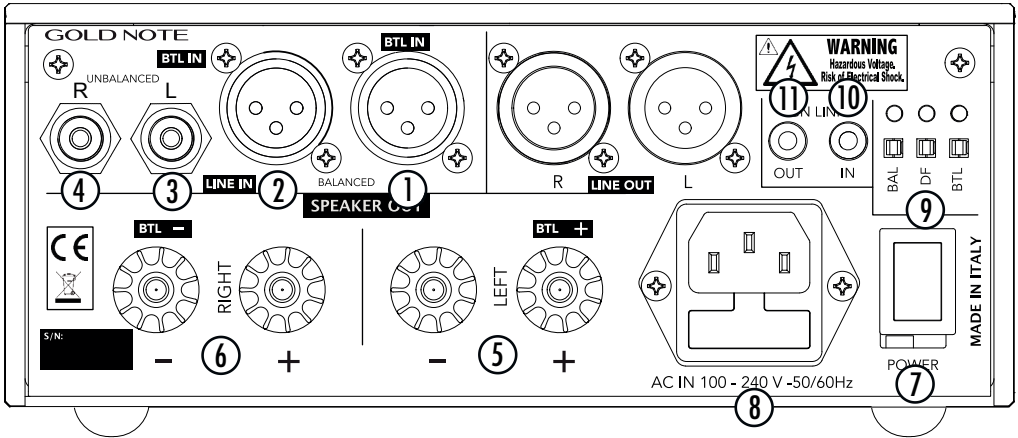

AUDIO INPUTS

STEREO MODE

1. XLR LEFT balanced input
2. XLR RIGHT balanced input
3. RCA LEFT unbalanced input
4. RCA RIGHT unbalanced input

PLEASE NOTE:

in mono mode (BTL) only the left inputs are active

SPEAKER OUT

STEREO MODE

5. LEFT CHANNEL
6. RIGHT CHANNEL

MONO MODE (BTL)

See [page 10](#) of this manual.

PLEASE NOTE:

the "left -" and "right +" outputs are electrically interconnected

POWER

7. MASTER SWITCH ON/OFF

8. AC IEC plug with integrated fuse holder drawer 6,3A T 5x20mm at 100/240V

9. Press BTL switch for use in Mono, the Led above turns blue.

Press DF switch for low damping factor, the Led above turns blue.

Press BAL switch to activate the XLR inputs, the Led above turns blue

GN LINK

10. 12V IN trigger with 3.5mm plug to synchronise the switching ON/OFF

11. 12V OUT trigger with 3.5mm plug to synchronise the switching ON/OFF

PA-10 INSTALLING

RCA CONNECTION

The PA-10 can be connected to your audio system via unbalanced RCA inputs or balanced XLR inputs. PA-10 allows you to compose systems with various elements, as shown in the following pages.

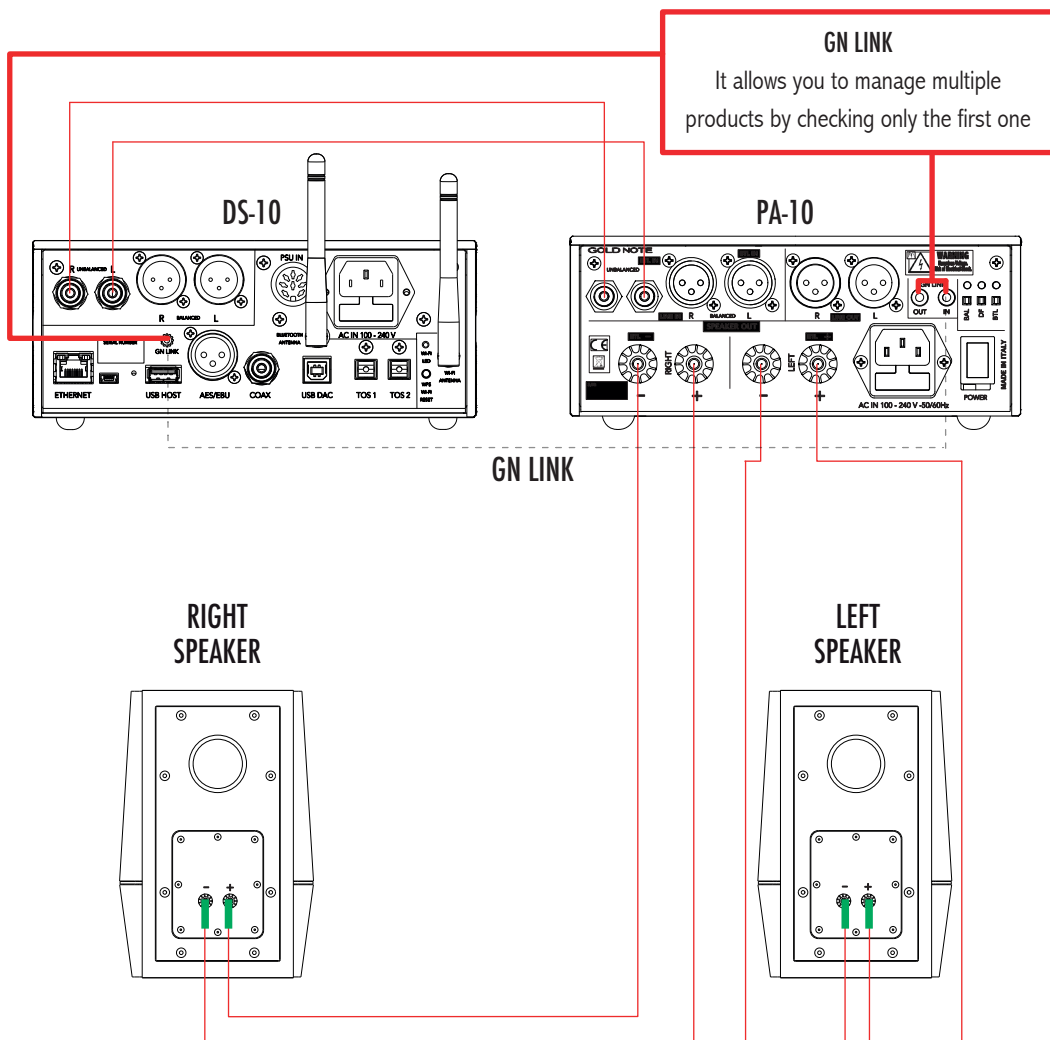

PA-10 INSTALLING

XLR CONNECTION

Press the BAL button on the rear of the PA-10 for this configuration.

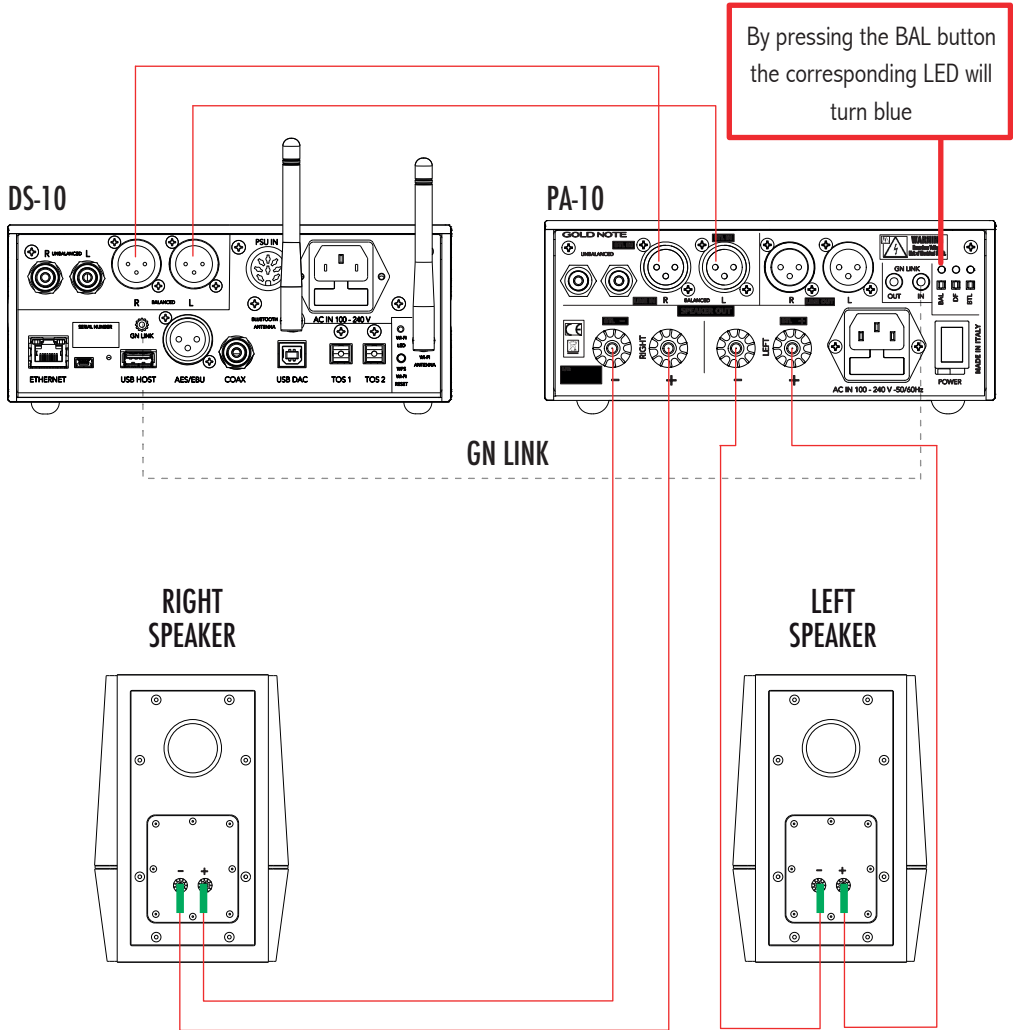

PA-10 INSTALLING

MONO MODE (BTL) CONNECTION WITH TWO PA-10

Press the BAL and BTL buttons of each PA-10 for this configuration.

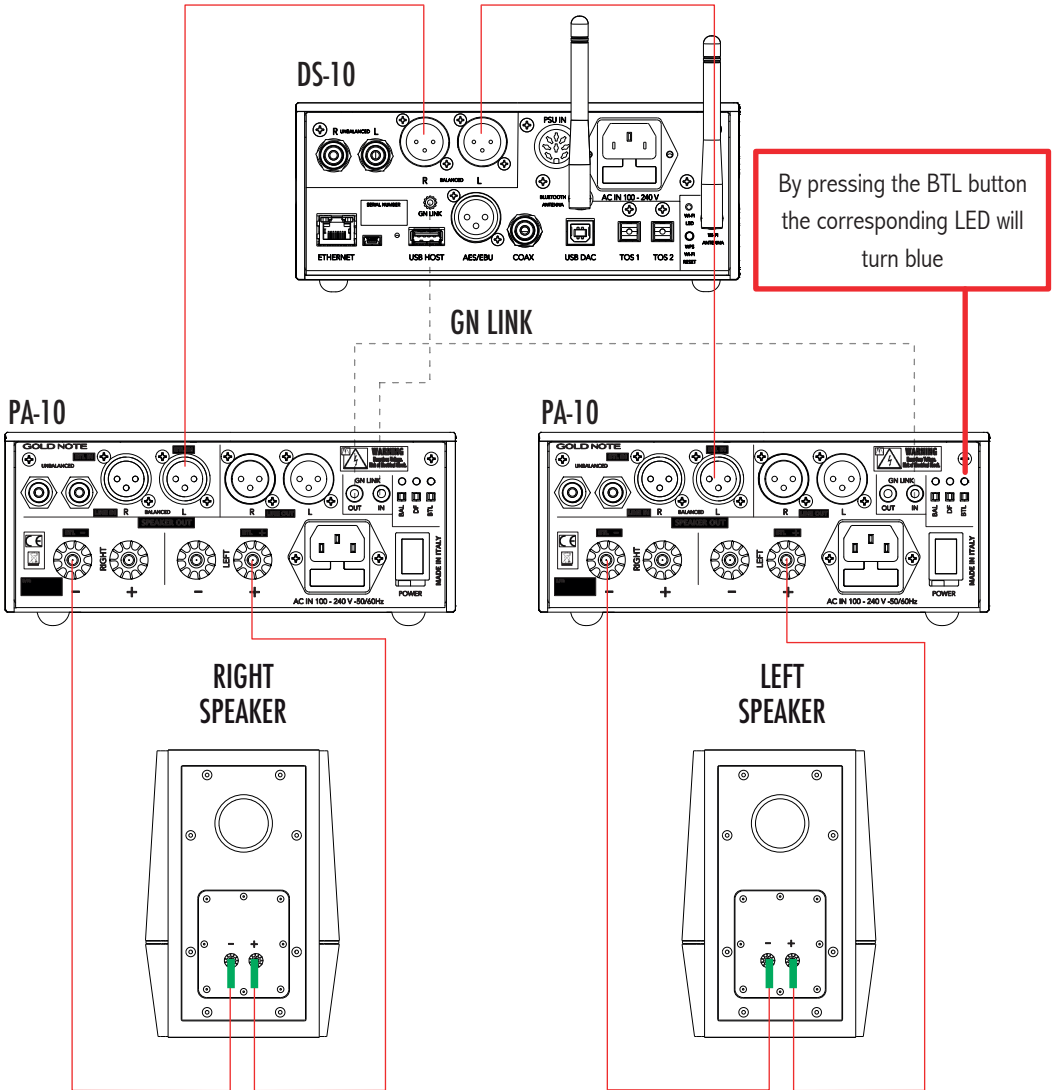

PA-10 INSTALLING

RCA CONNECTION WITH TWO PA-10

Press the BTL button of each PA-10 for this configuration.

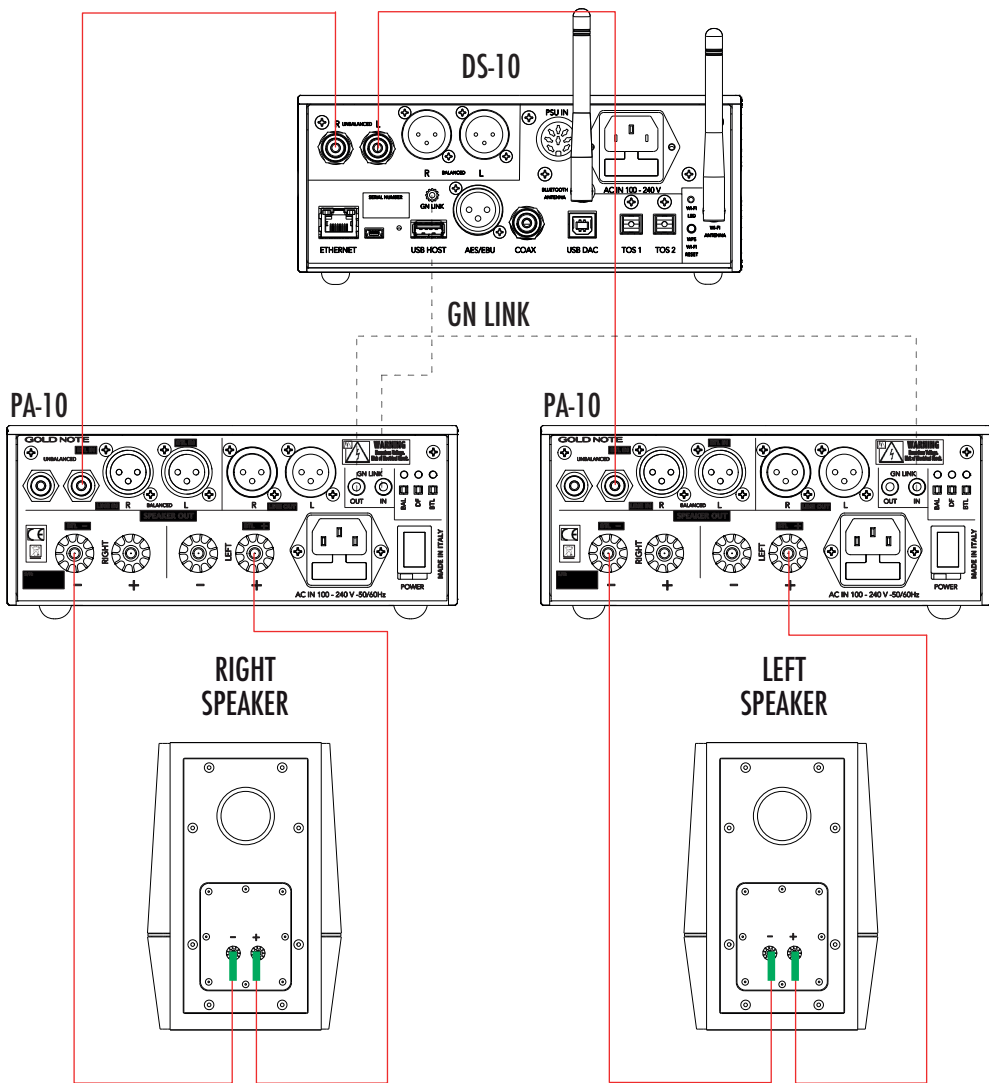

PA-10 INSTALLING

XLR CONNECTION WITH TWO PA-10 AND FOUR LOUDSPEAKERS

Press the BAL button of each PA-10 for this configuration.

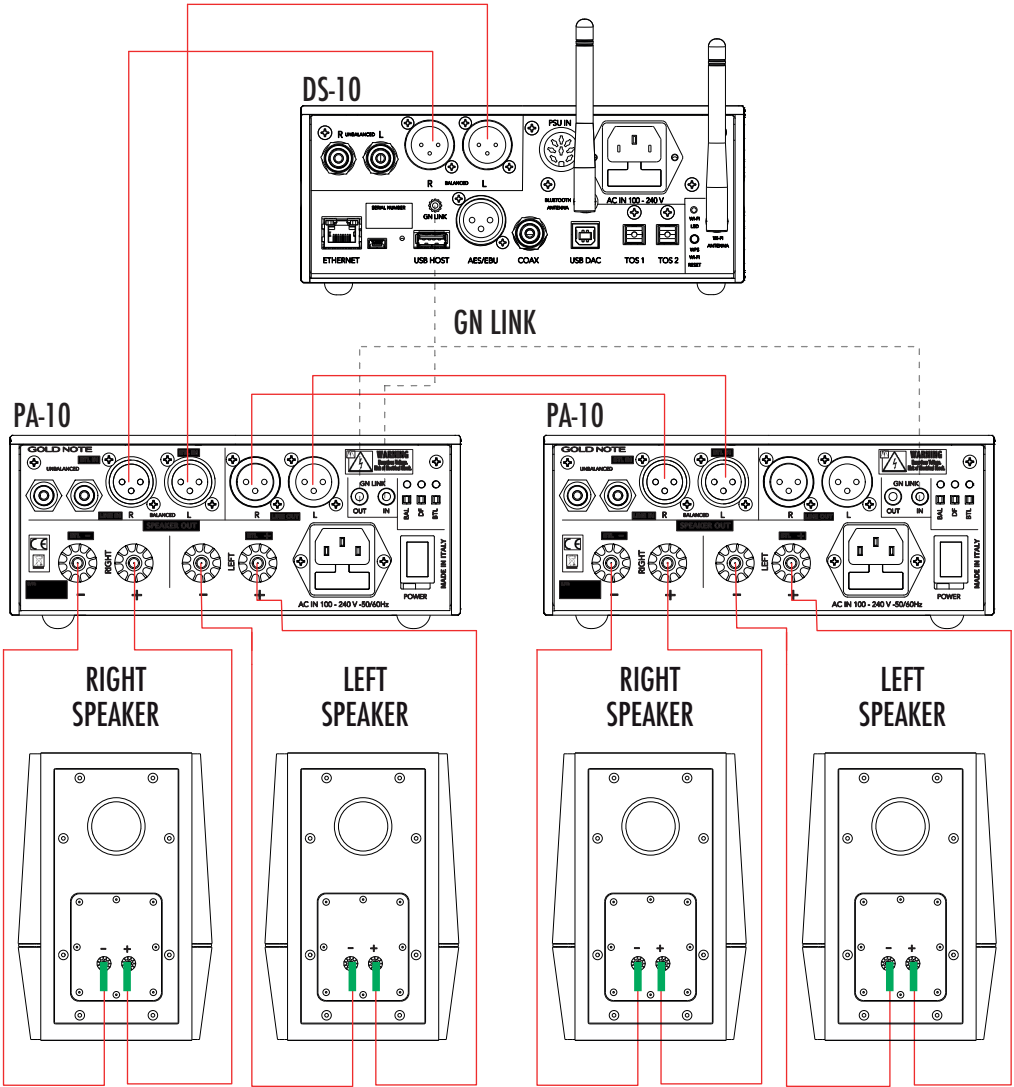

PA-10 INSTALLING

XLR CONNECTION WITH FOUR PA-10 AND FOUR LOUDSPEAKERS

Press the BAL and BTL buttons of each PA-10 for this configuration.

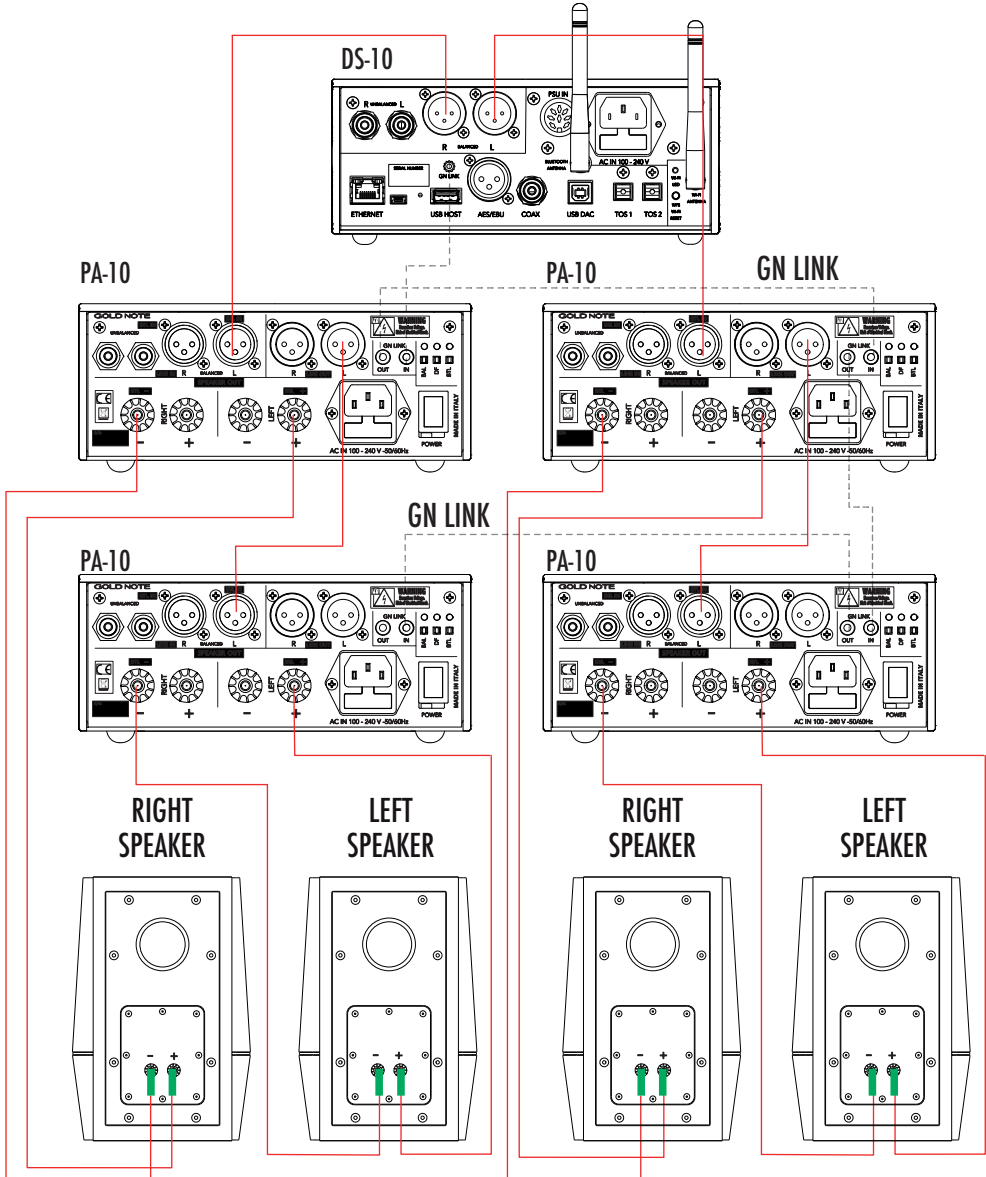

WARRANTY AND SERVICE

WARRANTY

To validate the warranty is necessary to register the unit on the Gold Note internet web site within 15 days from the purchase on the appropriate area of the web site: www.goldnote.it/warranty

If the unit is not registered correctly or has been purchased from a different country of the purchaser home address the unit will not be covered by any warranty and the registration will be refused.

The warranty does not cover in any case: Tubes, Phono Cartridge Stylus and Batteries.

SERVICE

Every GOLD NOTE® product is the result of meticulous technological research, and consequently their correct functioning is guaranteed. In spite of this it is possible that problems may emerge which non-specialist users cannot resolve.

In this case, contact your dealer to be advised on how the fault can be solved.

Do not return any object directly to the factory or to the distributor without being authorised to do so.

In such cases both GOLD NOTE® and the distribution agents decline responsibility of any kind.

For more information please visit www.goldnote.it/service

PLEASE NOTE

Descriptions and technical characteristics may vary at any time and without notice.

TROUBLESHOOTING

CLEANING THE UNIT
With EXTREME care use ONLY water or detergents for delicate surfaces with a very soft cloth to sweep dust and stains out. Any acid or not extremely soft cloth will irreversibly damage the amplifier fine aesthetic. Do not use alcohol.

DESCRIPTION	CAUSE	REMEDY
The speakers hum when the amplifier is connected to the system	The unit not is correctly coupled with the Ground on DC.	Ensure the system is well grounded and check the ground Pin on the power chord plug.
	The interconnect input and/or output cables are not shielded.	Be sure to always use shielded cables for the amp connections.
The unit buzzes every time it is turned ON or OFF		Turn Off the amplifier as first but turn it on as last of the audio system unit
The unit does not work when the stage is switched on	The AC Stage plug is disconnected from the AC wall plug	Connect it being sure that the AC wall plug works
	The interconnect cables are not properly connected to the amp.	Connect them properly
	One of the fuses is blown	Substitute the fuse with one of the same value (6,3A T 5x20)

If you have any questions contact us:

service@goldnote.it

For spare parts visit the official Gold Note store at:

www.akamaiaudio.it

IMPORTANT SAFETY INFORMATION



CAUTION!

TO REDUCE THE RISK OF ELECTRIC SHOCK, DO NOT REMOVE COVER (OR BACK). NO USER-SERVICEABLE PARTS INSIDE. REFER ONLY TO QUALIFIED GOLD NOTE SERVICE PERSONNEL FOR SERVICE



WARNING!

TO PREVENT FIRE OR SHOCK HAZARD, DO NOT EXPOSE THIS APPLIANCE TO RAIN OR MOISTURE

Do not disassemble any part of the product.

Do not use any part of the product for other purposes.

For service and problems of any kind, contact qualified Gold Note personnel.

Protect the product from rain, humidity and keep away from heat sources, electric and electronic motors etc.

The power Chord supplied must be used only on this unit.

Gold Note does not have responsibility for any improper use of this unit.

This appliance has a serial number located on the rear panel.

Please record the model and serial number and retain them for your records.

Serial Number: _____

Model: _____

IMPORTANT SAFETY INFORMATION

- 1.** Read these instructions and store them.
- 2.** Heed all warnings.
- 3.** Follow the instructions.
- 4.** Do not use this apparatus near water.
- 5.** Clean only with a dry cloth.
- 6.** Do not block the ventilation openings and install in accordance with the manufacturer's instructions.
- 7.** Do not install near heat sources such as radiators, heat registers, stoves or other apparatus (including amplifiers) that produce heat.
- 8.** Do not defeat the safety purpose of the polarised or grounding-type plug: a polarised plug has two blades with one wider than the other.

A grounding type plug has two blades and a third grounding prong. The wide blade or the third prong are provided for your safety.

If the provided plug does not fit into your outlet, consult an electrician for replacement of the obsolete outlet.

- 9.** Protect the power cord from being walked on or pinched particularly at plugs, convenience receptacles, and the point where they exit from the apparatus.
- 10.** Only use attachments/accessories specified by the manufacturer.

- 11.** Use only with the cart, stand, tripod, bracket, or table specified by the manufacturer, or sold with the apparatus.

When a cart is used, use caution when moving the cart/apparatus combination to avoid injury from tip-over.

- 12.** Unplug this apparatus during lightning storms or when unused for long periods of time.

- 13.** Refer all servicing to qualified service personnel only. Servicing is required when the apparatus has been damaged in any way (such as when the power cord or plug is damaged, liquid has been spilled or objects have fallen into the apparatus, the apparatus has been exposed to rain or moisture) and in any case when the apparatus does not operate normally or has been dropped.



 [goldnote_italy](https://www.instagram.com/goldnote_italy)

 [Gold Note Audio](https://www.facebook.com/GoldNoteAudio)

 [Gold Note](https://www.youtube.com/GoldNote)

Akamai S.r.l.
service@goldnote.it
www.goldnote.it