

AUDIONET

Scientific magic.



HUMBOLDT

User's Manual

AUDIONET

HUMBOLDT

Ultimate Analog Integrated Stereo Amplifier



User's Manual

AUDIONET

Scientific magic.

Contents

1	Preface	7
1.1	Included items	8
1.2	Transport	8
2	Overview front panel	9
3	Overview back panel	10
4	Installation and power supply	11
4.1	Placement	11
4.2	Mains connection	12
4.3	Orientation of mains plug	12
5	Inputs and outputs	13
5.1	Line level inputs	13
5.2	Speaker terminals	13
5.3	Preamplifier outputs	14
5.3.1	Bi-Amping	14
5.4	Audionet Link	15
6	Operating	17
6.1	Powering up	17
6.2	Switching on and off	18
6.3	Using Audionet Link	18
6.4	Control elements on the front panel	19
6.5	Volume control	19
6.6	Display	21
6.7	Input selection	22
6.8	Muting	23
7	Setup Menu	25
7.1	Global settings: Menu	28
7.1.1	Display	28
7.1.2	Balance	29

7.1.3	Power	30
7.1.4	Serial	32
7.1.5	By-Pass	33
7.1.6	Network	39
7.1.7	Reset	43
7.1.8	Info	45
7.2	Channel settings: Options	48
7.2.1	Offset	48
7.2.2	DC Servo	49
7.2.3	Name	50
7.3	Overview of factory defaults	51
8	Audionet Metal Remote Control	52
8.1	Key assignment	52
8.2	Changing the batteries	53
8.3	Settings for Audionet preamplifier	53
9	AN-Ultimates Control App	55
10	Network setup	56
10.1	Connecting to a wireless network	56
10.2	Setting up the Access Point Mode	58
10.3	Network trouble shooting	58
10.4	Updating the HUMBOLDT	61
11	Protection system	63
11.1	Monitoring mains power voltage	65
12	Security advice	67
13	Technical information	69
14	Technical data	71

I Preface

The Audionet Scientists Team and its leading scholars congratulate you on your purchase of this unit, sending cheers directly from our research and development center.

Audionet components are no marketing products, they are authentic. Conceived and developed with scientific inspiration, professional engineering expertise and a deep passion for achieving the truly perfect sound. They are unique creations designed to inspire musical enjoyment and have an excellent reputation amongst all connoisseurs throughout the world. Each and every one of our precision-manufactured devices is individually crafted by hand at our new Berlin headquarters. Built by audiophiles for audiophiles. With the utmost precision and total control of each and every perceptible detail.

Even if you're an experienced aficionado of ultra-highend components, please start listening to your new Audionet HUMBOLDT by reading this manual carefully before you plug it in. This will ensure you'll enjoy all functions of this unit without any compromise or potential disruption.

1.1 Included items

You will find the following items included:

- Stereo integrated amplifier HUMBOLDT
- Audionet Metal Remote Control
- WIFI antenna
- Power cord
- Batteries for the remote control
- Allen key for battery replacement
- Covers for serial ports
- Cover bag
- Gloves, 2 pairs
- User's manual (that you are currently reading)
- Red warning note
- Fumigation certificate

1.2 Transport



Important

- Only transport the HUMBOLDT in the original packaging.
- Always use the provided bag to prevent scratches on the casing.
- Please allow the HUMBOLDT to adapt to the climatic conditions in your listening room before you switch the unit on for the first time after the transport.

2 Overview front panel

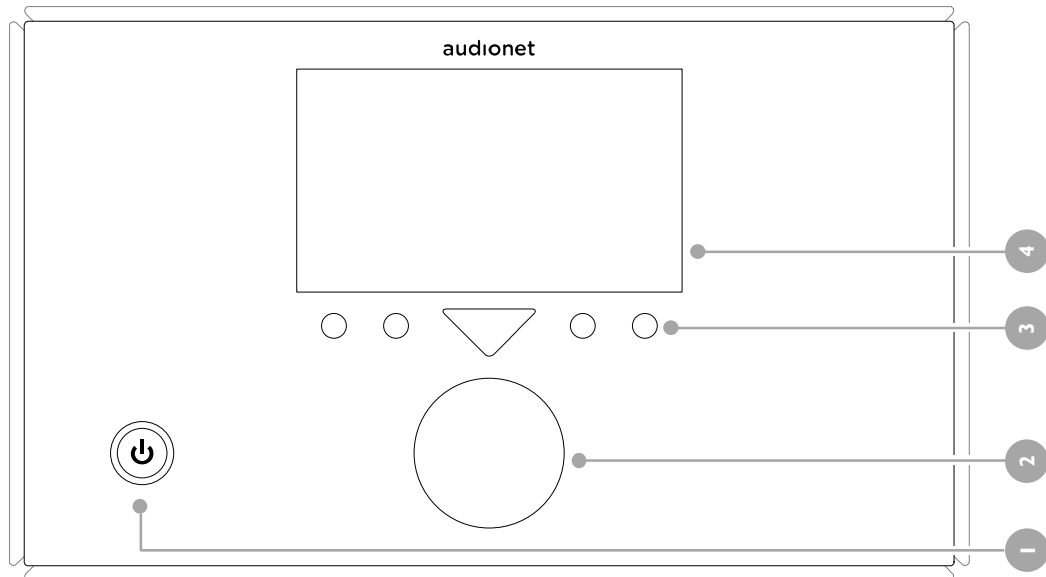

- 1 power key
- 2 rotary encoder
- 3 keys (dynamically assigned functions)
- 4 display

3 Overview back panel

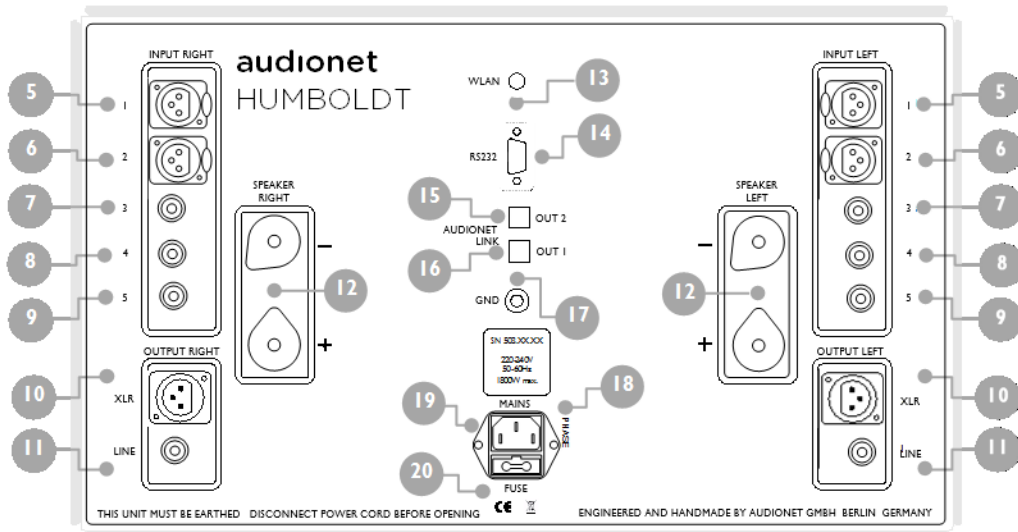

- 5 balanced (XLR) in 1
- 6 balanced (XLR) in 2
- 7 line in 3
- 8 line in 4
- 9 line in 5
- 10 balanced (XLR) out
- 11 line out
- 12 speaker terminal
- 13 WLAN antenna socket
- 14 serial port (RS232)
- 15 'Audionet Link' out 1
- 16 'Audionet Link' out 2
- 17 additional ground terminal
- 18 'mains phase' marking
- 19 mains power input
- 20 fuse compartment

4 Installation and power supply



Important

- While connecting and removing sources, amplifiers or speakers to the HUMBOLDT, all units of your audio system have to be switched off to prevent damage to the HUMBOLDT or any connected units.
- Please make sure that all cables are in absolute best conditions! Broken shields or short-cut cables could damage the HUMBOLDT and/or any other unit connected.

4.1 Placement



Important

- It is recommended to place the HUMBOLDT into a high-quality rack or onto a stable table.
- Do not expose the unit to direct sunlight.
- Do not place the HUMBOLDT in close range to heat sources like radiators.
- Do not cover the ventilation openings on top of the HUMBOLDT.
- Do not place any other unit on top of the HUMBOLDT.
- Do not place the HUMBOLDT on top of other units. Especially not on top of power amplifiers, preamplifiers or similar components that produce heat. Both units could suffer damage from thermal overload.
- Do not use the unit in places where it is exposed to vibrations.
- Do not place the unit close to loudspeakers or into the corner of a room where it is exposed to high levels of sonic energy, which might reduce the sound quality.

4.2 Mains connection

The mains power input ¹⁹ is on the back panel of the HUMBOLDT. Use the included power cord to connect the unit to mains. If you prefer to use a different power cord, make sure that it meets the specifications for your home country.



Important

- The electrical specifications of your home country must meet the electrical specifications printed onto the back panel.
- The HUMBOLDT is a Class I unit and must be earthed. Please ensure a stable earth connection. The phase ('hot' pin) is marked on the back panel ('PHASE') ¹⁸.
- Never pull the mains plug while the HUMBOLDT is switched on! Before you pull the power cord off its socket ¹⁹ at the back panel, power down the unit to stand-by mode first.

The HUMBOLDT should only be switched off from the mains in cases of extended absence (like vacations) or if massive trouble on the mains power is to be expected. Pull the power cord off the mains power input socket ¹⁹ to completely disconnect the unit from mains.



Tip

- The use of high quality power cords could improve the sound quality. Please ask your local retailer for more information.

4.3 Orientation of mains plug

The correct polarization of mains is important for reasons of audio clarity and stability. Please connect the power cord so that the hot pin of the wall outlet is connected to the pin of the mains power input ¹⁹ marked with 'PHASE' ¹⁸.





5 Inputs and outputs



Important

- While connecting and removing sources, amplifiers or speakers to the HUMBOLDT, all units of your audio system have to be switched off to prevent damage to the HUMBOLDT or any connected units.
- Please make sure that all cables are in absolute best conditions! Broken shields or short-cut cables could damage the HUMBOLDT and/or any other connected unit.

5.1 Line level inputs

The HUMBOLDT is equipped with two balanced (XLR) '1'  and '2'  as well as three Cinch (line) inputs '3' , '4'  and '5'  for connecting signal sources at line level. Due to its double mono design, left and right channel input jacks are separated on the back panel.

Please connect the left and right input of the same number printed on the back panel of the HUMBOLDT to the corresponding output of the source which you would like to connect to the HUMBOLDT.

5.2 Speaker terminals

Connect your speakers to the rhodium plated terminals SPEAKERS RIGHT and SPEAKERS LEFT  on the back panel of the HUMBOLDT. You may use banana plugs or spades as well as simple cable ends. Fasten speaker terminals until the torque stop clicks distinctly. The torque stop guarantees for the right fastening torque at all times ensuring a safe contact.



Note

- Look out for the correct connection of your speaker cables. Usually, the terminals of your speakers are marked '+' and '-'. The HUMBOLDT uses the same labels.
- Wrong speaker polarization will result in severe loss of sound quality.



Important

- Although the HUMBOLDT has an effective protection system to prevent damage to the circuits, always switch off the unit while working on the speaker and/or audio cables.
- The nominal loudspeaker impedance should be 4 Ohms or higher.
- Never use force or tools to tighten the terminal screws.

5.3 Preamplifier outputs

The HUMBOLDT is equipped with one balanced (XLR) ⑩ and one Cinch (line) output ⑪ – left and right channel each – to connect the unit to additional amplifier(s) (e.g. for bi-amping purposes) or subwoofer. The preamplifier outputs are always active and provide a volume controlled full-range signal. Due to the double mono design the left and right output jacks are separated.

Use the left and right Cinch (line) output ⑪ to connect the HUMBOLDT to additional power amplifier(s) or subwoofer using high quality Cinch cables. Alternatively, you may connect a power amplifier using the balanced (XLR) outputs ⑩ in case the additional power amplifier or subwoofer does not support Cinch (line) inputs.

5.3.1 Bi-Amping

While bi-amping, each loudspeaker is controlled by two power amplifiers: one amplifier for the bass range and one for the high- and midrange. Generally, this setup leads to an increase of the sound quality.

For the purpose of bi-amping the HUMBOLDT has one Cinch (line) output ⑪ or one balanced (XLR) output ⑩ for each channel. Thus, making it very easy to make all the necessary connections for a bi-amping setup, e.g. using the HUMBOLDT speaker outputs ⑫ to connect to the high/midrange terminal of your speakers, and connect an additional power amplifier to the bass range terminals of your speaker.



Important

- In most cases loudspeakers are equipped with bridges installed between the terminals for bass and high/mid-range. These bridges have to be removed before you connect two power amplifiers to each speaker. Otherwise the power amplifiers might get damaged!
- Please consult the user's manual of your speakers to find out if the speakers support bi-amping and how they have to be set up correctly.

5.4 Audionet Link

For your convenience, the HUMBOLDT is able to switch all other Audionet units (e.g. power amplifiers) on or off, that are connected via 'Audionet Link' (e.g. by a simple touch on the included remote control or the power key on the front panel).

Only a simple optical 'Toslink' cable is needed. Connect the 'Audionet Link' output ⑩ of your HUMBOLDT to the 'Audionet Link' input of unit to be controlled.

The HUMBOLDT is equipped with two identical 'Audionet Link' outputs. In case you would like to control more than one Audionet unit via 'Audionet Link', use the second 'Audionet Link' output ⑪ of your HUMBOLDT as well.

The 'power on' signal of the 'Audionet Link' output 2 ⑪ is slightly time-delayed in regard to the 'Audionet Link' output 1 ⑩ in order to prevent all by 'Audionet Link' connected devices switching on at the same time. Otherwise this could result in an overload of your home fuse.



Tip

- Audionet source units and power amplifiers are usually equipped with an 'Audionet Link' input and additionally with an 'Audionet Link' output to connect further Audionet devices to be controlled via 'Audionet Link' in a daisy chain. Connect the 'Audionet Link' output to the 'Audionet Link' input of the next unit, using a simple optical 'Toslink' cable. This will allow you to switch your complete Audionet system on and off by your Audionet integrated amplifier.

6 Operating

All functions of the HUMBOLDT are microprocessor controlled. This guarantees highest precision, exclusive functions, easy handling and protection against operating errors.

6.1 Powering up

First of all, please make sure your HUMBOLDT is connected correctly to your signal sources, speakers and mains power (refer to sections 'Installation and power supply' on page 11 and 'Inputs and outputs' on page 13).

The HUMBOLDT is a stand-by unit. Please insert the power cord into the mains input socket 19 on the back panel and connect the HUMBOLDT to mains power. The display 4 shows a welcome message for a brief moment. After that the HUMBOLDT is in stand-by mode. The display turns dark now.

The HUMBOLDT should only be switched off from the mains in cases of extended absence (like vacations) or if massive trouble on the mains power is to be expected. Pull the mains plug off the mains input socket 19 to completely disconnect the unit from mains.



Important

- Never pull the power cord while the HUMBOLDT is up and running!
- Before you disconnect the power cord, always power the unit down to stand-by mode first.
- If you disconnect the HUMBOLDT from mains power, first power down and completely discharge all units connected to the outputs of the HUMBOLDT first.

6.2 Switching on and off

Press the  key **1** on the front panel to power up the HUMBOLDT from stand-by mode. The HUMBOLDT issues the message [Waking up...](#) and shows the normal operating screen afterwards. The unit is in normal operating mode now.

If you would like to switch off the unit, please press the  key **1** on the front panel. The display **4** shows the message [Going to sleep...](#)

While the power supply of the HUMBOLDT is discharged the display **4** shows the message [Discharging... please wait](#). After the discharging is done, the display turns dark indicating that the unit is in stand-by mode now.



Note

- Of course, you may switch the HUMBOLDT on and off with the included Audionet Metal Remote Control. For detailed information please refer to section 'Audionet Metal Remote Control' on page 52.
- During powering down, you may re-start the HUMBOLDT by pressing the the  key **1** on the front panel. The display **4** shows the message [Re-starting...](#)

6.3 Using Audionet Link

Your HUMBOLDT is equipped with two 'Audionet Link' outputs **16** and **17**, allowing you to switch further Audionet units (e.g. power amplifiers, CD player or tuner) on and off, if they are connected via 'Audionet Link' (refer to section 'Speaker terminals' on page 13).

If further Audionet units are connected to your HUMBOLDT via 'Audionet Link', these linked units will be switched on and off automatically, as soon as you switch the HUMBOLDT on and off by using the  key **1** on the front panel or the remote control.

**Note**

- The 'power on' signal is issued to the 'Audionet Link' output 2 ¹⁹ of the HUMBOLDT with a small delay in order to prevent all connected from units powering up at the same time, which could overload your home fuse.
- Please do read the section 'Speaker terminals' on page 13 and consult the user's manuals of your Audionet components connected via 'Audionet Link' for further information.

6.4 Control elements on the front panel

The front panel has six keys to control the HUMBOLDT (refer to section 'Overview front panel' on page 9). You can control all functions with these keys as well as all setup options to adjust the unit to your preferences (see section 'Setup Menu' on page 25).

Use the  key ¹ to switch the HUMBOLDT on or off. There is a circular operating indicator around the key, which lights up when the HUMBOLDT is up and running, ready to play back music.

The five keys ³ directly underneath the display ⁴ are dynamically assigned with functions by the current operating mode of the HUMBOLDT. The given function of a key is shown as text in the display right above each key. If no text is displayed, the key has no function in the present operating mode.

The rotary encoder ² is used to control the volume setting of the HUMBOLDT (see the following section 'Volume control') but as well for navigating through the menus and user options.

6.5 Volume control

The rotary encoder ² on the front panel of the HUMBOLDT is used to set the desired volume level. Turn the rotary encoder clockwise to increase and counter clockwise to decrease the volume.

The volume control of the HUMBOLDT has a range from -80 dB to $+10$ dB in real 1 dB steps relatively to the level of the input signal. Differences in input levels can be adjusted for each input channel of the HUMBOLDT separately (see section 'Offset' on page 48).

The rotary encoder is a magnetically buffered incremental impulse encoder without an end stop.

The display shows the current volume level in dB during the change of the volume level as well as a bar graph of the volume in an enlarged manner for a better readability:

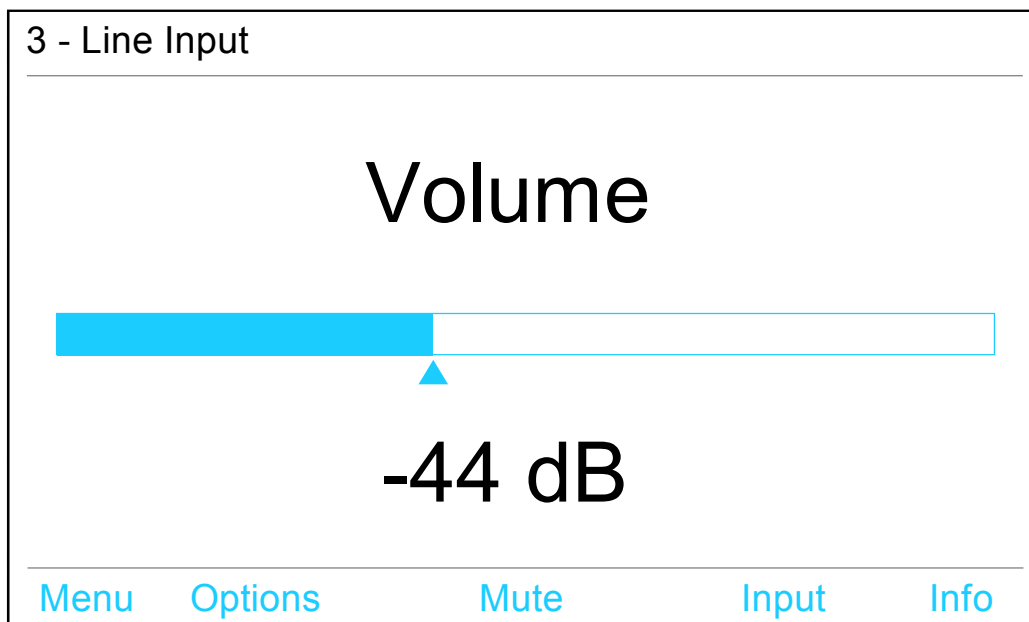

Several seconds after the last volume change the display will revert to the normal operating screen.



Note

- The rotary encoder ② is also used for navigating through the menus (see section 'Setup Menu' on page 25) as well as for selecting the input channel (see section 'Input selection' on page 22).
- Use the keys '**VOL+**' and '**VOL-**' (see section 'Key assignment' on page 52) to control the volume with the Audionet Metal Remote Control.

6.6 Display

The display ⁴ provides the following information in normal operating mode:

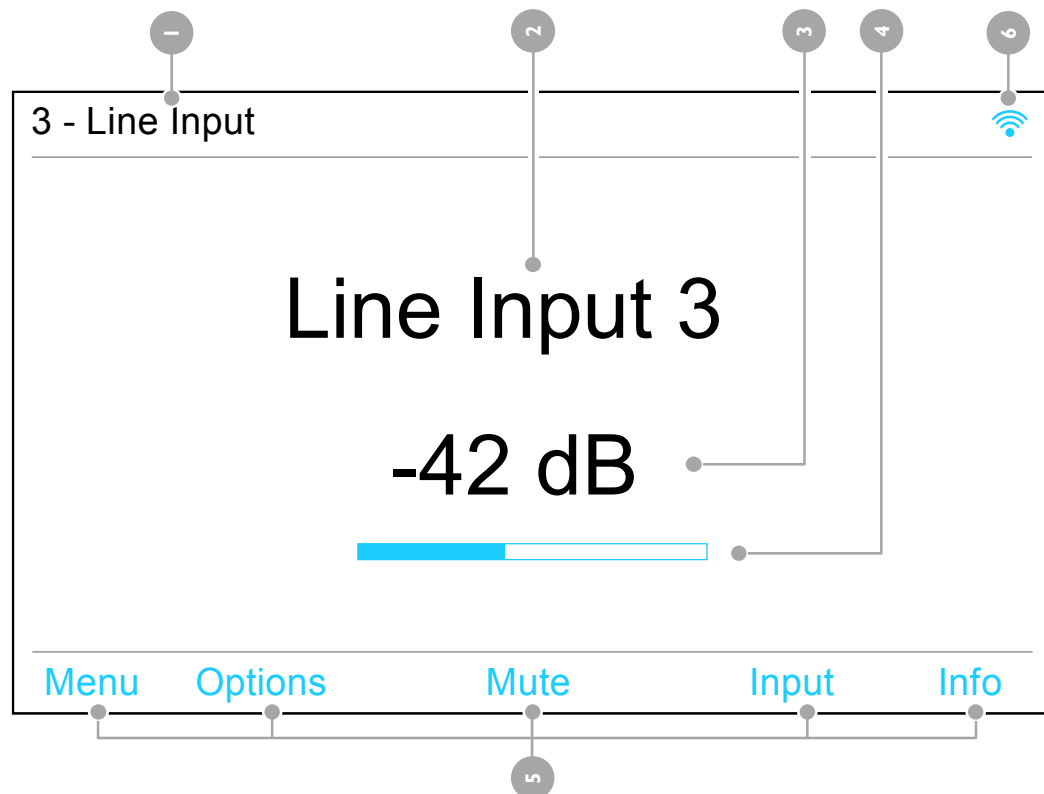

- 1 Number and type of the currently selected input channel, corresponding to the number printed above the input jack on the back panel (refer to section 'Overview back panel' on page 10).
- 2 Name of the currently selected input channel, fully user-definable (see section 'Name' on page 50).
- 3 Current volume level in dB relative to the input level (refer to previous section 'Volume control').
- 4 Bar graph display of the current volume setting.
- 5 Currently assigned functions to the keys ³ beneath the display.
- 6 Status of the wireless connection (see section 'Wireless' on page 39).

As soon as you push one of the keys beneath the display or change the volume by using the rotary encoder, the display will change to show information related to the new operating mode. For further display details refer to the description of each menu item in section 'Setup Menu' starting from page 25.

6.7 Input selection

Push the **Input** key on the front panel while the HUMBOLDT is in normal operating mode. Afterwards select the desired input channel by using the rotary encoder. The display shows the following input selection screen:

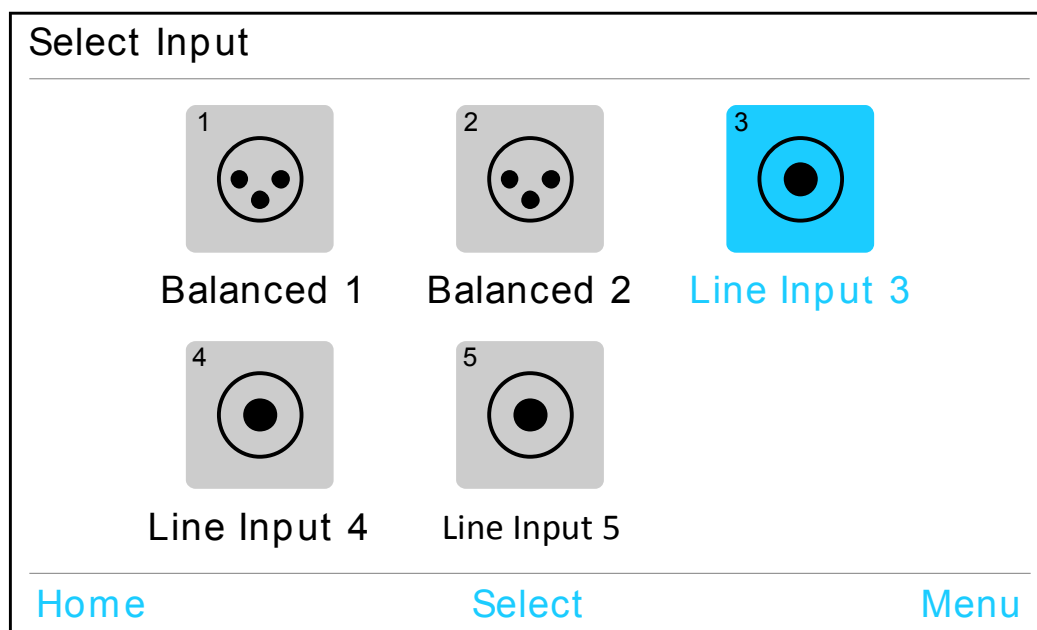

The icon of the currently selected input channel and its user-defined name is highlighted in blue. In order to actually switch to the selected input channel press the **Select** key.

If you would like to go back to the main screen of the normal operating mode, press the **Home** key. Use the **Menu** key to enter the setup menu.

The HUMBOLDT features a 'soft' input selection. While switching inputs, the volume is decreased to -80 dB first, followed by a deactivation of the outputs. Afterwards the input section switches to the new input channel, followed by the activation of the outputs and finally the increase of the volume up to its original level.

**Note**

- To switch to the next or previous input channel by using the Audionet Metal Remote Control, select an input channel by using the keys 'CH+' and 'CH-' (refer to section 'Key assignment' on page 52).

**Tip**

- If you are within one of the setup menus and would like to change the volume, press the [Home](#) key first to get back to the main screen. Afterwards you are able to use the rotary encoder to change the volume level.
- Basically, the function [Home](#) is always assigned to the most left key beneath the display.

6.8 Muting

While the HUMBOLDT is in normal operating mode, press the [Mute](#) key on the front panel to mute or un-mute the volume.

As well as during an input selection, the HUMBOLDT uses 'soft' muting. The volume is stepped down gently to -80 dB. Afterwards the outputs are switched off. The displays second line informs on a muted unit with the text [mute](#) instead of the volume value in dB.

To un-mute the HUMBOLDT, press the [Mute](#) key again. The outputs are switched back on and the volume is stepped up gently to its original level afterwards.

**Note**

- You may of course select a different input channel as described above, while the unit is muted. But the HUMBOLDT will of course stay muted, until you push the [Mute](#) key again to un-mute the unit.
- If you turn the rotary encoder clockwise, i.e. you turn up the volume while the unit is muted, the new volume level will be set and the unit is un-muted.

- To control the muting of your HUMBOLDT by the Audionet Metal Remote Control, use the  key (see section 'Key assignment' on page 52).



Tip

- If you are within one of the setup menus and would like to mute the volume, press the [Home](#) key first to get back to the main screen and press the [Mute](#) key afterwards.
- Basically, the function [Home](#) is always assigned to the most left key beneath the display.

7 Setup Menu

To adjust the HUMBOLDT to your preferences, please use both setup menus [Menu](#) and [Options](#). Both of the keys [Menu](#) and [Options](#) are always available on the main screen of the display.

All global settings are located within the setup menu [Menu](#). The global settings are applied to all input channels independently.

Press the [Menu](#) key on the front panel to enter the menu for the global settings:

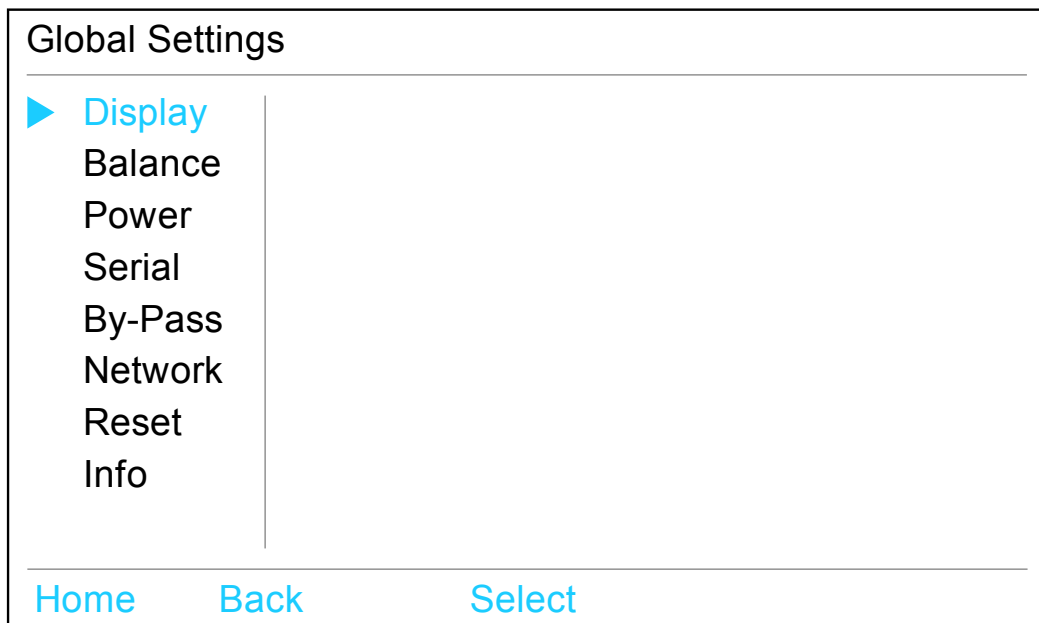

The status bar on the top of the display informs on the active menu, sub-menu or menu item.

All settings that are only applied to the currently selected input channel are determined in the setup menu [Options](#) instead.

Press the [Option](#) key on the front panel to enter the menu for the channel-dependent settings:

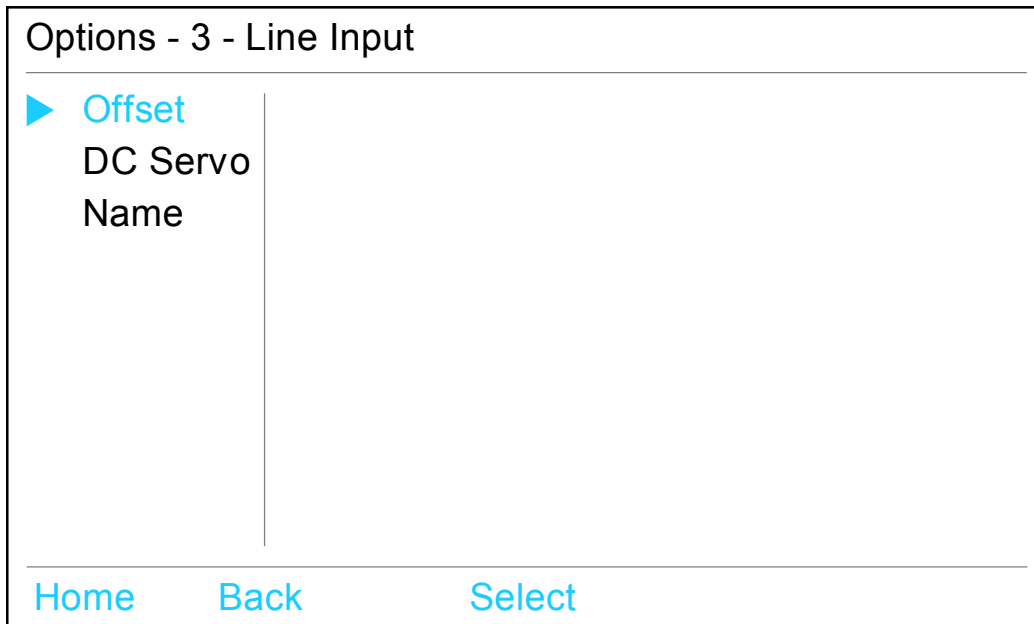

The status bar on the top of the display area informs you on the currently selected input channel to which the settings apply as well as on the selected menu item.

Use the rotary encoder [2](#) and the [Select](#) key for navigating through the menus. Turning the rotary encoder moves the triangular cursor up and down from one menu item to the next. Press the [Select](#) key to enter the selected menu item.

While inside one of the menu items, use the rotary encoder to select a setting. Press [Save](#) key to save the selected setting to the non-volatile memory of the HUMBOLDT. The display acknowledges the procedure with the message '[Saved](#)'.

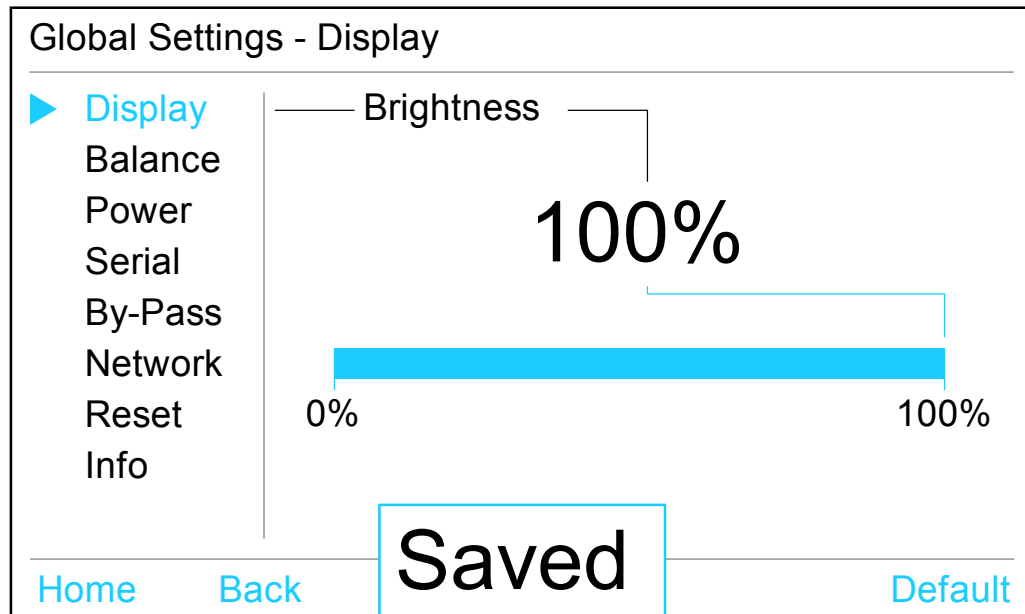

After saving the setting, the display of the HUMBOLDT reverts to its main screen.

You will always return to the menu level above by pressing the [Back](#) key. The [Home](#) key directs all the way back to the main screen. Both keys [Home](#) and [Back](#) are available in all menu items. They are always assigned to the left most keys beneath the display.

Almost every settings screen has the function [Default](#) assigned to the right most key beneath the display. This key does always reset the currently edited setting to its factory default value. In order to acknowledge and store the default value, the [Save](#) key has to be used afterwards.



Tip

- If you would like to reset all user settings to the factory default values at once, navigate to the menu item [Reset](#) in the global settings menu [Menu](#) and select the entry [Reset All Settings](#) (see section 'Reset' on page 43).



Note

- HUMBOLDT will automatically leave the setup menu and return to normal operations mode, if no adjustments are made within 12 seconds.
- If the HUMBOLDT is powered down to stand-by mode, all settings are stored automatically in the non-volatile memory of the unit. Even after disconnecting from mains, HUMBOLDT still remembers your settings.

7.1 Global settings: Menu

7.1.1 Display

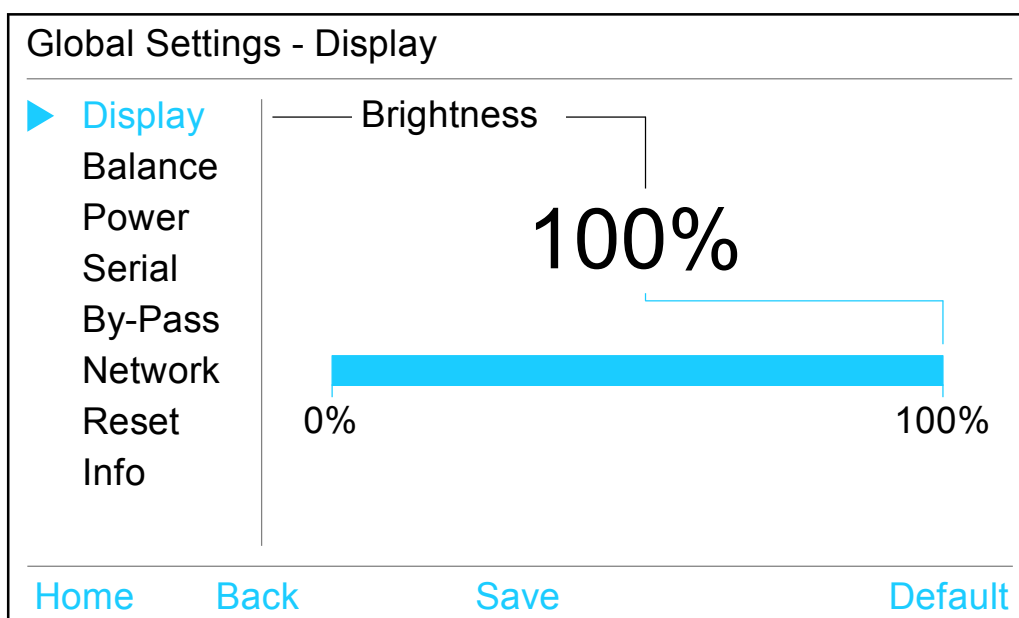

Use the rotary encoder ② on the front panel to adjust the brightness of the display. Turn clockwise to increase or turn counter clockwise to decrease the brightness.



Note

- If the brightness is set to 0%, the display is only activated during setup or volume adjustments. It switches off automatically several seconds after the last user entry.

7.1.2 Balance

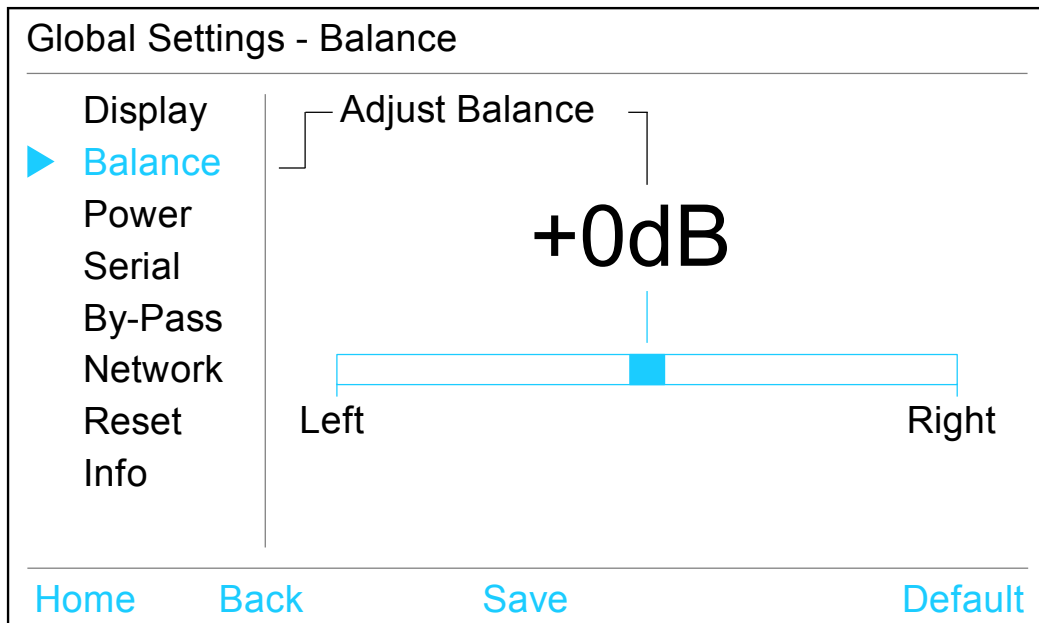

Adjust the balance by using the rotary encoder **2** on the front panel. Turn it clockwise to shift the balance to the right. The display shows the volume difference in dB between the left and the right channel. A positive value stands for a balance shifted to the right.

Turn the rotary encoder counter clockwise to shift the balance to the left. The value in the display turns negative.

HUMBOLDT allows a shift of the balance up to 9 dB to the left or the right.

The displayed bar graph visualises a balance shift to the left or the right side with a blue rectangle.



Note

- A balance shift is carried out internally by attenuating the corresponding channel. If the balance is shifted to the right, the level of the left channel is attenuated and vice versa.

7.1.3 Power

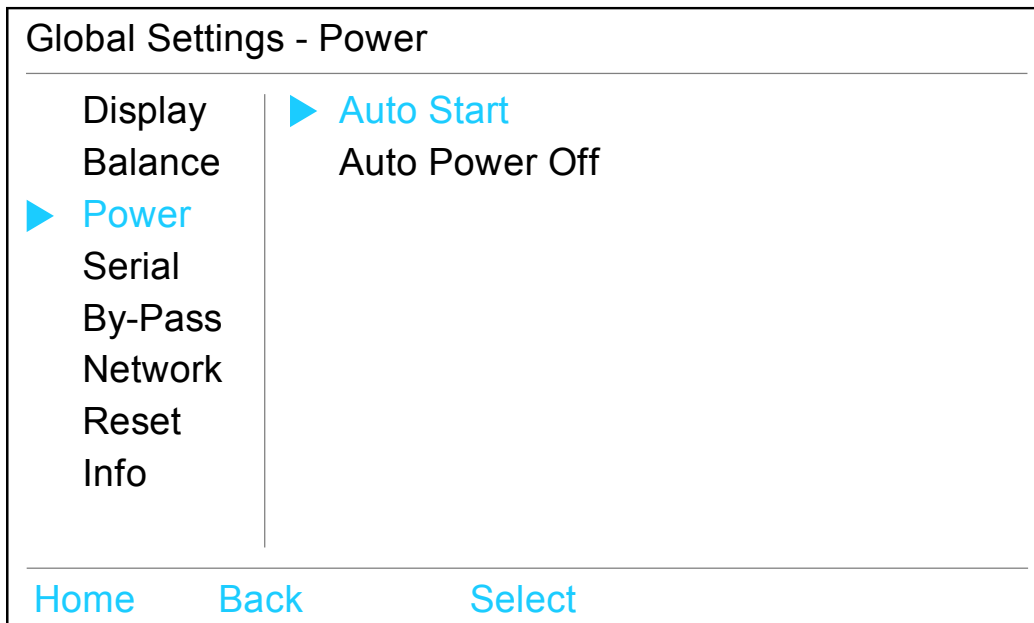

The sub-menu [Power](#) consists of the two options [Auto Start](#) and [Auto Power Off](#).

Auto Start

Turn the rotary encoder [2](#) on the front panel clockwise to activate the Auto Start function. Turn the rotary encoder counter clockwise to disable the Auto Start function.

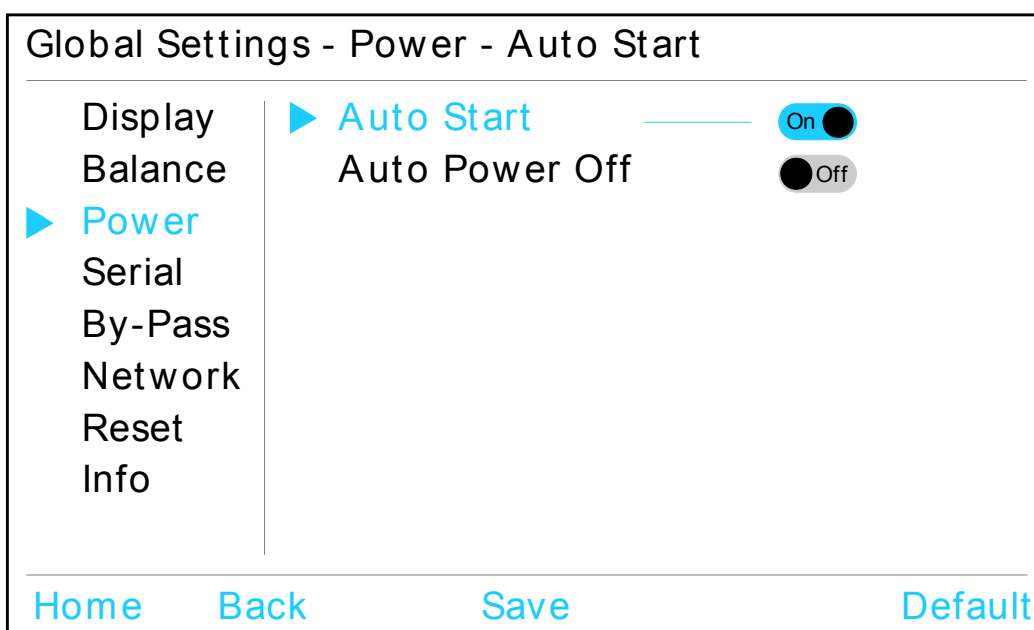

- Off** The Auto Start function is disabled. If you connect the unit to mains power, HUMBOLDT will go into stand-by mode. You have to push the  key **1** on the front panel or alternatively the '**HUMBOLDT**' key of the Audionet Metal Remote Control to start up the unit into normal operating mode.
- On** The Auto Start function is active. As soon as you connect the unit to mains power, HUMBOLDT will start up and automatically turn on the normal operating mode. Select this setting for timer controlled operations.

Auto Power Off

The Audionet HUMBOLDT is equipped with an input signal detection circuit. The HUMBOLDT will shut down automatically (Auto Power Off function) when no input signal is detected for a period of 20 minutes on the currently selected input channel.

Turn the rotary encoder **2** clockwise to activate the Auto Power Off function of HUMBOLDT. Turn the rotary encoder counter clockwise to disable the Auto Power Off function.

- Off** The Auto Power Off function is disabled. HUMBOLDT will stay powered on, not matter if there is an input signal on the currently selected input channel or not. You have to push the  key **1** on the front panel or alternatively use the '**HUMBOLDT**' key of the Audionet Metal Remote Control to power the unit down into stand-by mode.
- On** The Auto Power Off function is active. If no input signal is detected on the currently selected input channel for a period of more than 20 minutes, HUMBOLDT will automatically power down to stand-by mode.

7.1.4 Serial

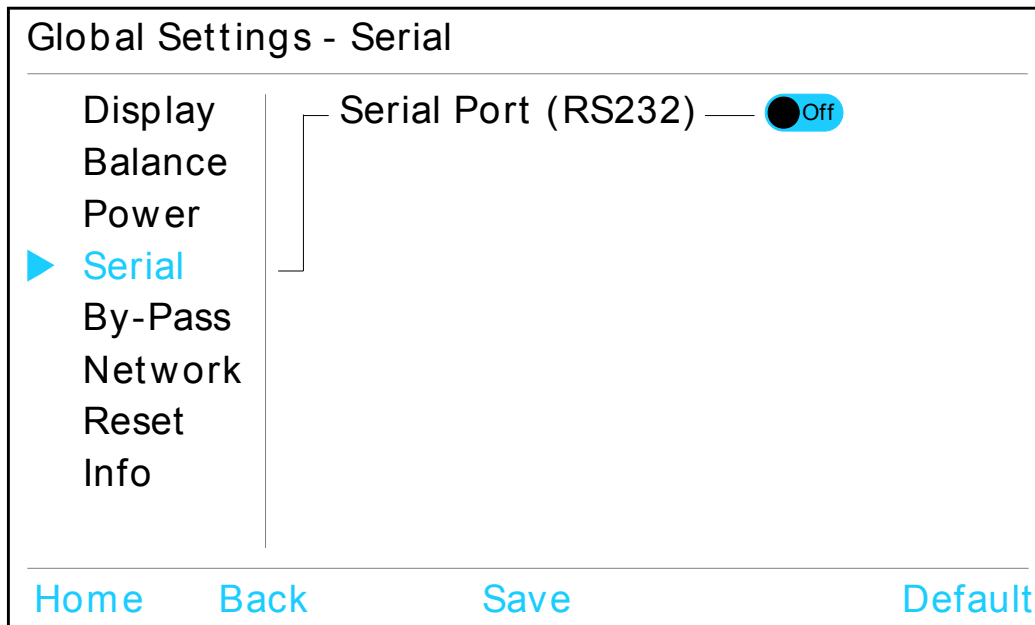

The serial port (RS232) ⑰ on the back panel is used for communications between the HUMBOLDT and home automation systems, that are equipped with a serial port.

Turn the rotary encoder ② clockwise to activate the serial port of the HUMBOLDT. Turn it counter clockwise to disable the serial port.

Off The serial port is disabled. Communications between a home automation system and the HUMBOLDT via the RS-232 interface are deactivated. Use this setting if the HUMBOLDT is not connected to a home automation system.

On The serial port is active. The HUMBOLDT is now controlled by a home automation system via the RS-232 interface.



Important

- If you want to use the serial port ⑰ for controlling the HUMBOLDT, it has to be activated (On).
- While the serial port is active, the HUMBOLDT will have an increased power consumption during stand-by mode.
- Disable the serial port, if you do not wish to control the HUMBOLDT via serial port (e.g. with a home automation system).

7.1.5 By-Pass

The sub-menu 'By-Pass' consists of two menu items: [Input for By-Pass](#) and [DC Servo for By-Pass](#).

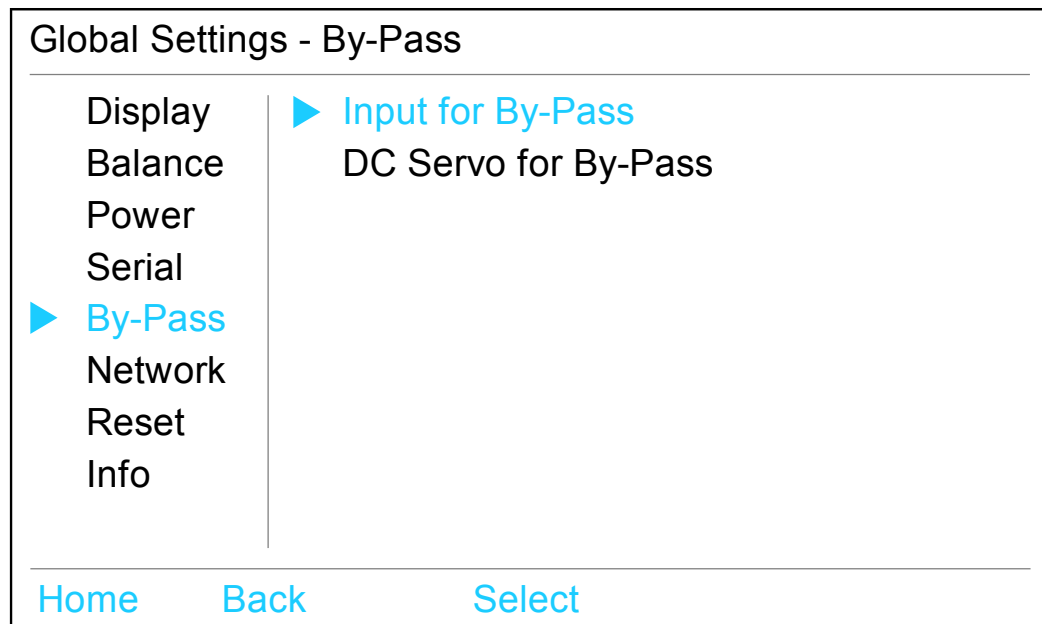

Input for By-Pass

Use the rotary encoder ② on the front panel to select the input channel you would like to use for the By-Pass Mode.

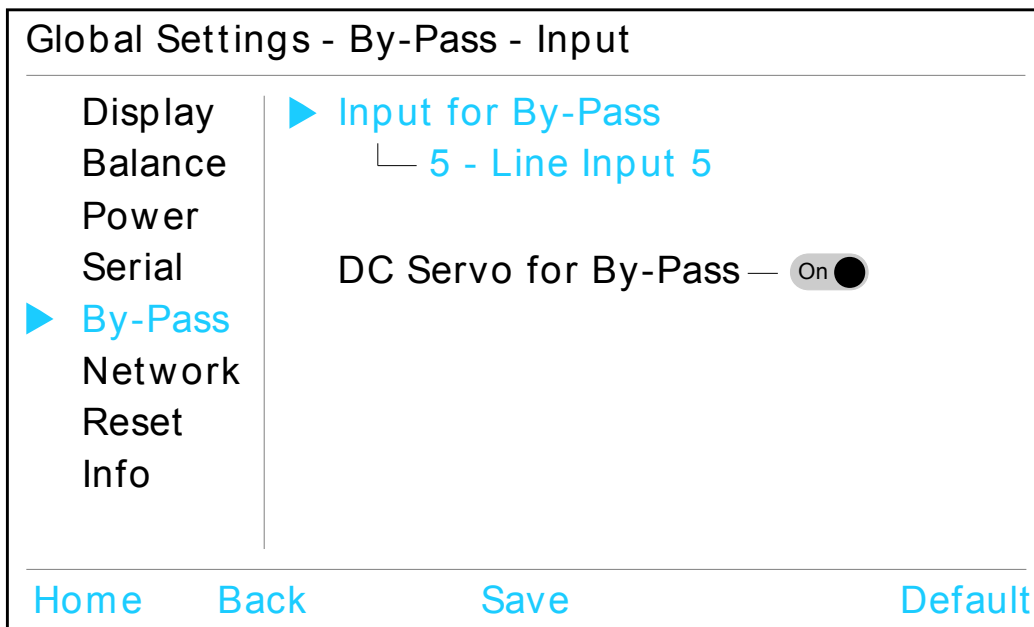

The display shows the selectable input channel with its input number (as printed on the back panel) and its user-defined name. Acknowledge and save your selection by pressing the [Save](#) key.

Press the [Default](#) key to reset the By-Pass Mode to the factory default setting '0 - No Input'. Confirm the change with the [Save](#) key afterwards.



Note

- The display shows [0 - No Input](#) if no input channel is selected for the By-Pass Mode (factory default).
- If an input channel is selected for the use in By-Pass Mode, its icon on the input selection screen reflects this setting by the additional text [By-Pass](#) on the bottom of the channel icon:

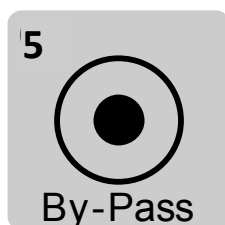



Important

- An input channel that is used for the By-Pass Mode must be selected within this menu item before you can use the By-Pass Mode.
- No input channel is pre-selected as factory default for the By-Pass Mode for safety reasons (display: 0 - No Input).

The By-Pass Mode is primarily intended to integrate the overwhelming sound quality of the HUMBOLDT into an existing home cinema setup or to expand an existing excellent stereophonic system based on the HUMBOLDT to a complete home cinema setup without missing out on the qualities of the HUMBOLDT. To implement this kind of setup, please proceed as follows:

- 1 Connect your home cinema preamplifier according to its user's manual.
- 2 Do not connect the output for the front channels Left and Right to the power amplifier but to one of the free inputs of the HUMBOLDT instead.
- 3 In the next step connect the outputs of the HUMBOLDT to the corresponding power amplifier for the channels Left and Right.
- 4 Use the menu item [Input for By-Pass](#) in the setup menu of the HUMBOLDT to select the input channel for By-Pass Mode, which you connected the outputs Left and Right of the home cinema preamplifier to.
- 5 Now connect all high quality 2-channel analog sources to the remaining inputs of the HUMBOLDT.
- 6 Connect your DVD / BluRay player to your home cinema preamplifier.

Use the HUMBOLDT to listen to high quality analog sources. If you would like to use your home cinema system, activate the By-Pass Mode of the HUMBOLDT and use your home cinema preamplifier as usual.



Important

- Please read the complete section about the special function By-Pass Mode first, before using this function in order to prevent maloperations and possible damage to your audio system and/or hearing.
- No input channel is selected by factory default for the By-Pass Mode. Use the menu item [Input for By-Pass](#) to select desired input channel for the By-Pass Mode.

While the By-Pass Mode is active, the volume control of the HUMBOLDT is bypassed. The HUMBOLDT passes the input signal through to the outputs with its full level.

The special function By-Pass Mode of your HUMBOLDT is activated automatically if you switch to the input channel dedicated to the By-Pass Mode which you selected in this menu item. The signal at the input channel selected for By-Pass Mode operations is passed through the HUMBOLDT at a level of 0 dB (i.e. no change in volume level) to the outputs.

As soon as you select a different input channel, the By-Pass Mode function is switched off automatically. The volume is reset to its prior level.



Important

- Please check the correct connection and setup before you use the By-Pass Mode for the first time. The input signal will be passed through to the outputs at **full level!**

As soon as the By-Pass Mode is activated, the HUMBOLDT will ignore all control commands coming from the keys on the front panel or remote control (exceptions see below)!



Important

There are only two possibilities to disable the By-Pass Mode:

- I Select a different input channel. The HUMBOLDT switches back to the now selected input channel, resetting the volume to its prior level.

- Push the **⏻** key **1** on the front panel or the '**HUMBOLDT**' key on the Audionet Metal Remote Control. The HUMBOLDT powers off to stand-by mode.



Note

- If you leave the By-Pass Mode by pushing the **⏻** key **1** on the front panel or the '**HUMBOLDT**' key on the Audionet Metal Remote Control, this mode will be saved, i.e. if you switch on the HUMBOLDT, the unit will switch to the last saved input channel selection and thus into By-Pass Mode.

DC Servo for By-Pass

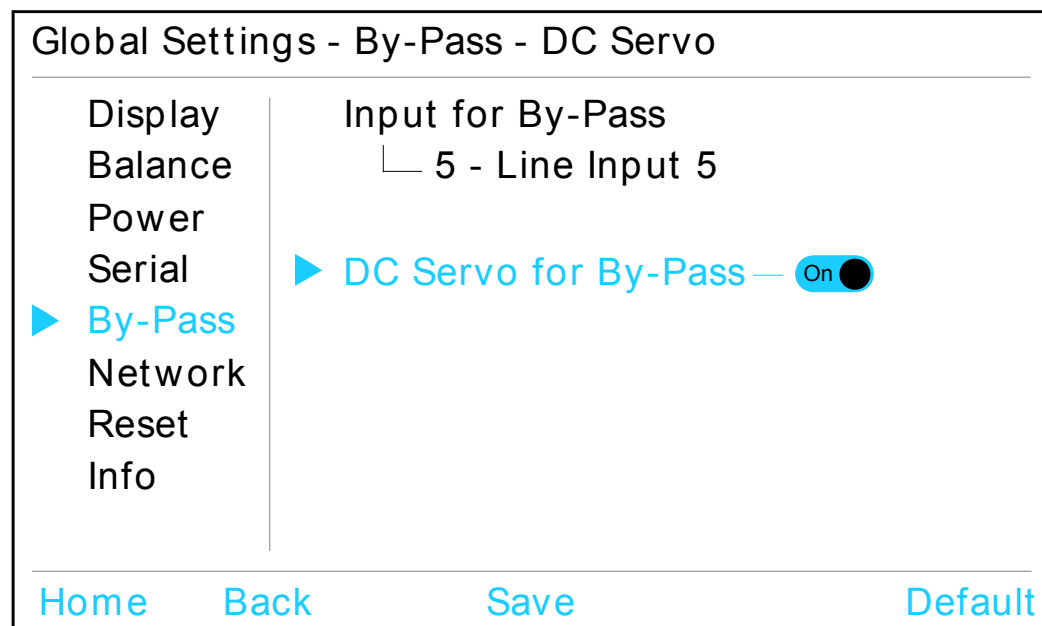

Turn the rotary encoder **2** clockwise to activate the DC Servo during By-Pass Mode. Turn the rotary encoder counter clockwise to switch off the DC Servo during By-Pass Mode.

Off The DC Servo is disabled for the By-Pass Mode.

On The DC Servo is activated for the By-Pass Mode.

Only do activate the DC Servo in cases where the source connected to the HUMBOLDT holds a high DC component in its output signal. The DC Servo eliminates the DC component. The input channel dedicated to the By-Pass Mode is now AC-coupled. As factory default the DC Servo for By-Pass Mode is activated.



Note

- The setting of the DC Servo for the By-Pass Mode is completely independent to the DC Servo settings for the input channels.

7.1.6 Network

The Network menu contains three items: [Wireless](#), [Connection](#) and [Update](#).

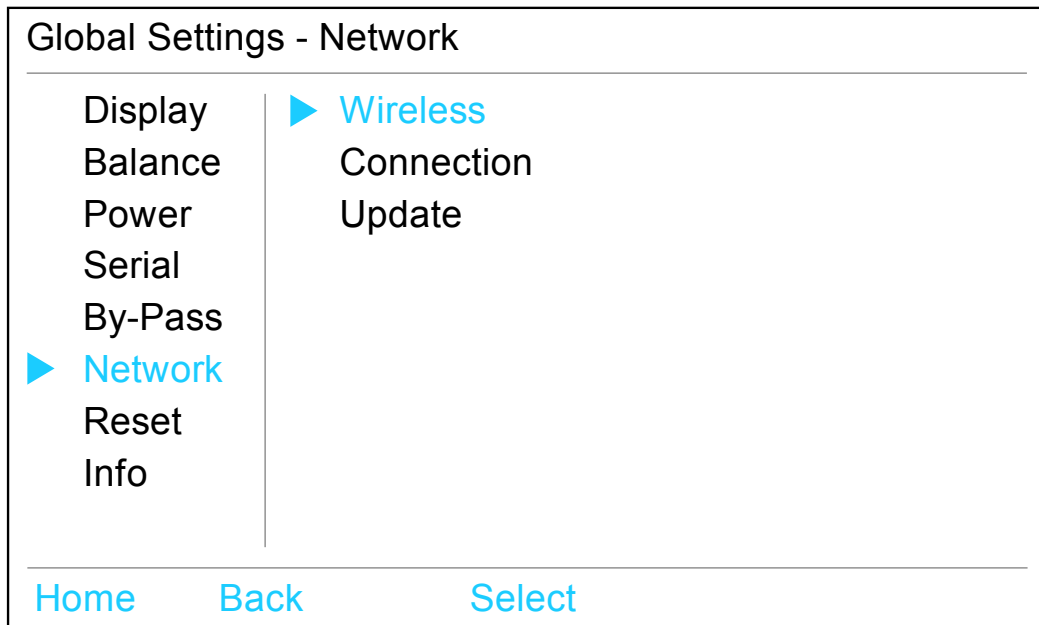

Wireless

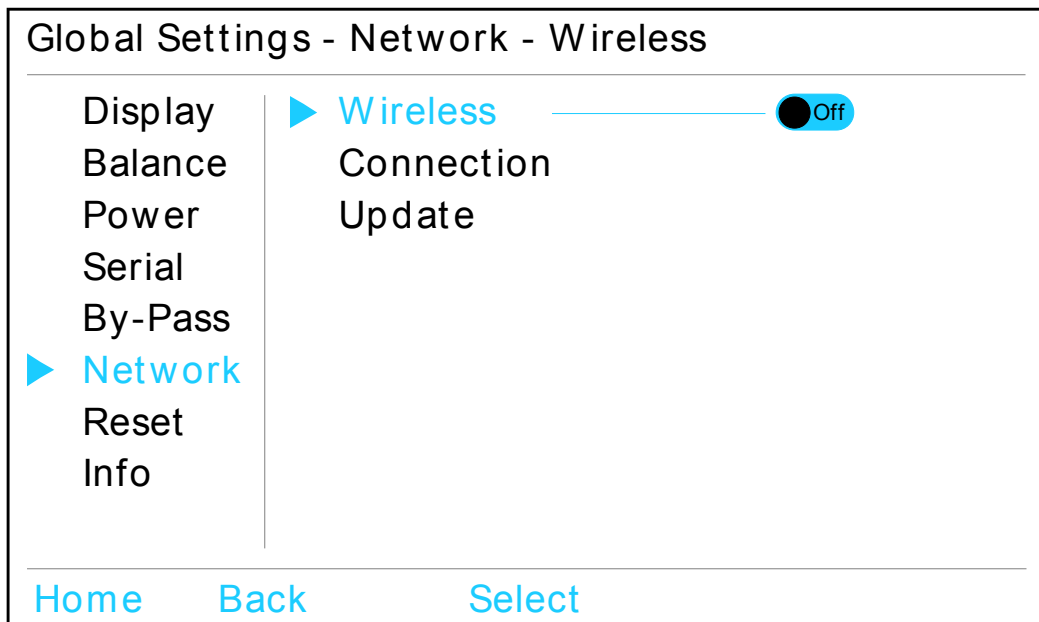

Turn the rotary encoder ② clockwise to activate the wireless network connection. Turn the rotary encoder counter clockwise to switch off the wireless network connection.

Off The wireless network is disabled.

On The wireless network is activated.

In order to control the HUMBOLDT via app, the wireless network has to be set to active. If you do not intend to use the network control, keep the wireless network disabled.

The status bar on the top right edge of the display informs you on the status of the wireless network connection (see section 'Display' on page 21):

No Icon Wireless network module is disabled.



Wireless network module is active and provides a stand-alone access point (see section 'Setting up the Access Point Mode' on page 58).



Wireless network module is active and connected to the selected wireless network (see section 'Connecting to a wireless network' on page 56). The number of blue bars correspond to the received signal strength.



Wireless module is active and executes an action. The text to the left of the symbol indicates the type of action:

boot Module starts up

scan Search for wireless networks in the vicinity

connect Logging onto the selected network in progress

no Text Network error (see section 'Network trouble shooting' on page 58)

Connection

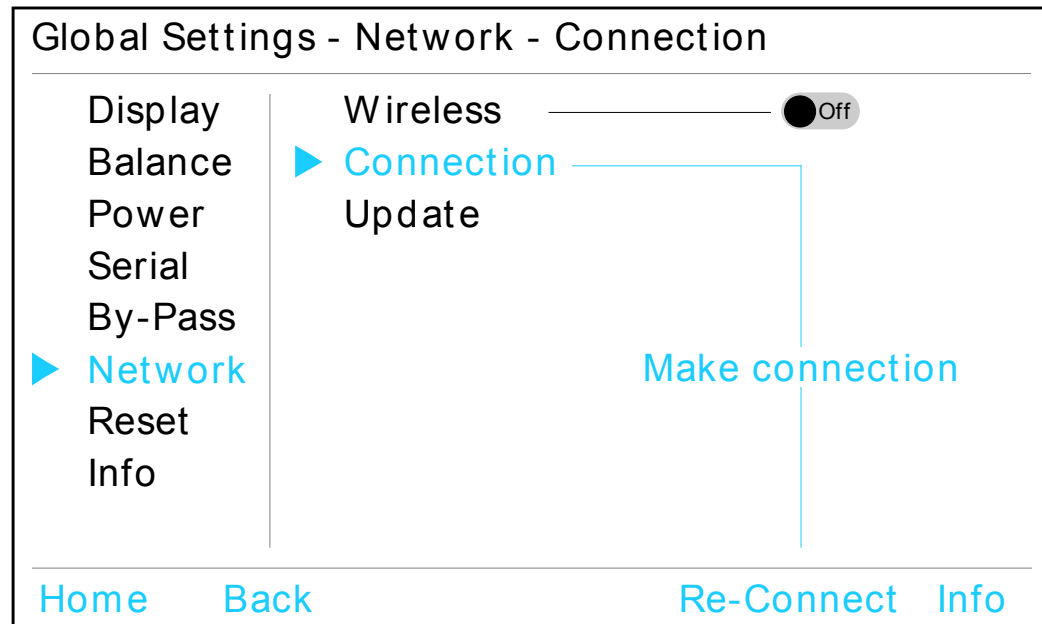

Re-Connect Press key to re-start the wireless connection.

Info Redirects directly to info page 4 (refer to section 'Info' on page 45).

For information on how to setup the wireless network please refer to section 'Network setup' on page 56.

Update

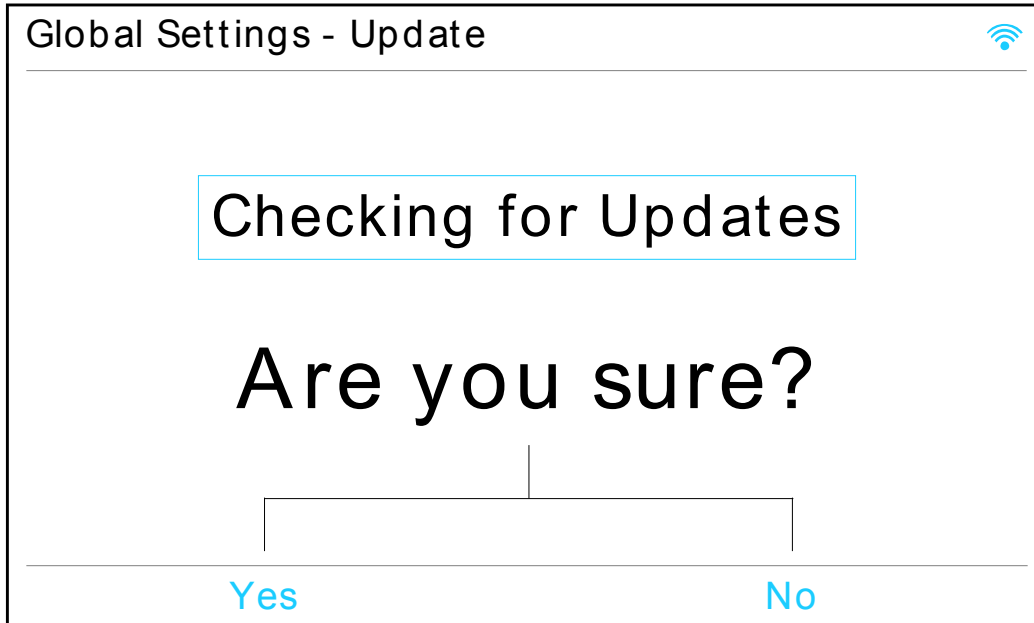

Press **Yes** to let HUMBOLDT search for firmware updates. Press **No** to leave this menu item without checking for updates.

If any updates are found, HUMBOLDT starts the update process. A progress bar will appear and inform you on the status. Please wait until the update process has finished. The HUMBOLDT will re-boot automatically and is ready for the playback of music afterwards.



Important

- Do not disconnect the HUMBOLDT from mains power while the update process is running!
- This menu item does only check the local internal memory for pending updates.
- For information on how to check for updates on the Audionet Server and how to download them to the HUMBOLDT please refer to section 'Updating the HUMBOLDT' on page 61.

7.1.7 Reset

The menu [Reset](#) consists of the two items [Reset All](#) and [Reset Network](#).

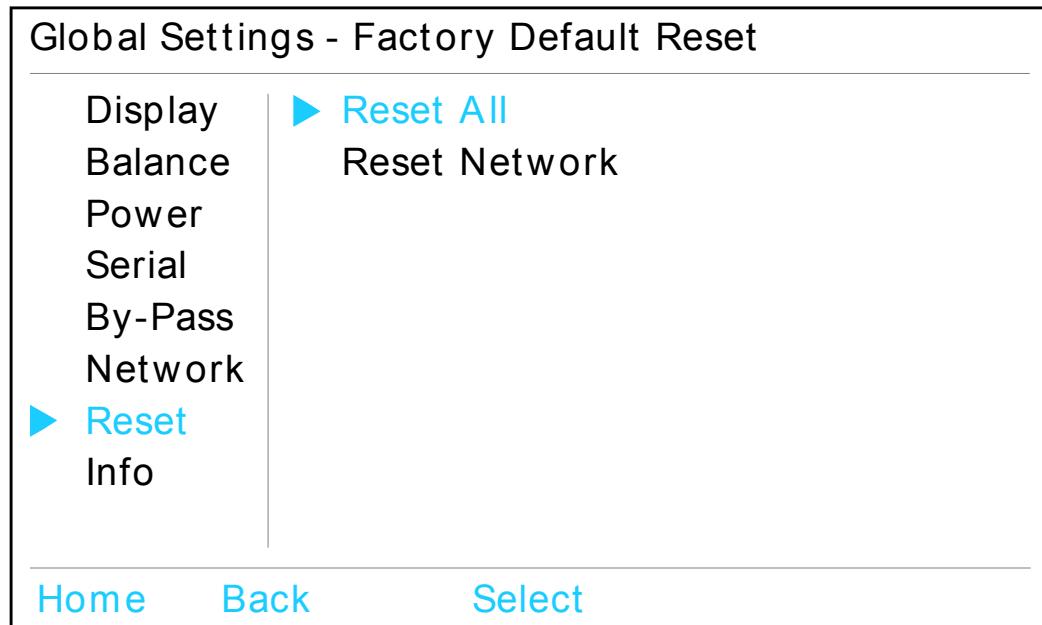

Use the menu item [Reset All](#) to reset all settings to the factory defaults except for the network settings. The menu item [Reset Network](#) resets all network settings to their factory defaults.

After you press the [Select](#) button to choose one of the above listed reset methods, HUMBOLDT will ask you to confirm, if you are sure to start the resetting process.

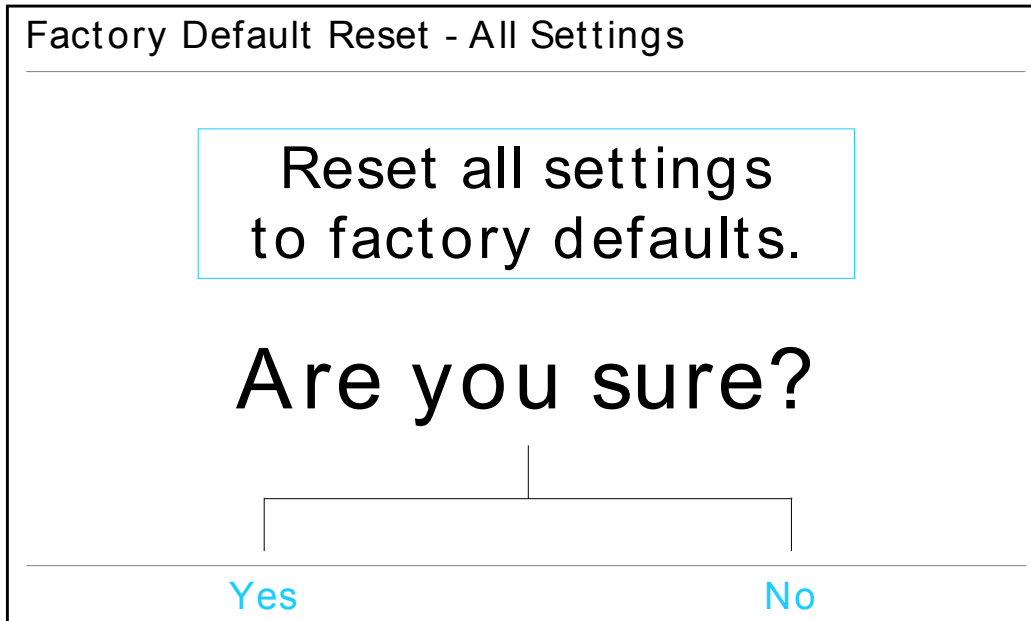

Press the **Yes** key to start the resetting process. All settings are reset to factory defaults afterwards.

Press the **No** key instead, if you want to cancel the reset process and leave without resetting the HUMBOLDT.

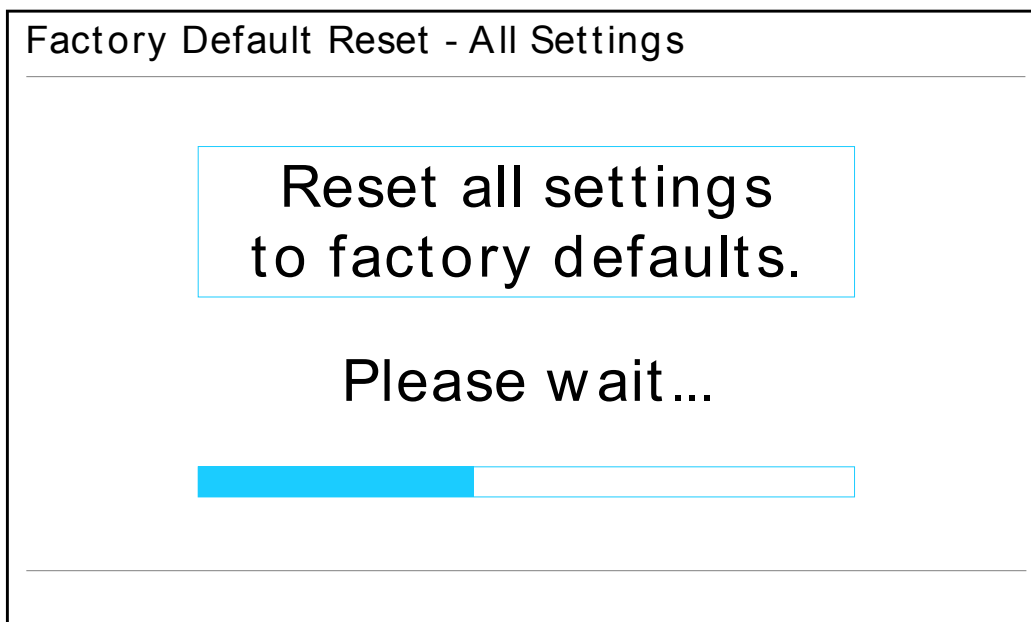

After the confirmation of the resetting process, a progress bar informs on the current status. Also refer to the section 'Network trouble shooting' on page 58.

7.1.8 Info

The menu item **Info** provides the user with a quick overview of the user settings. Four info pages are available. Use the keys **Next** and **Prev** to skip to the next or previous info page. The status bar on the top of the display corner shows the number of the currently displayed info page.

Info page 1 contains an overview on all global settings:

Global Settings - Info (1 of 4)

<ul style="list-style-type: none"> Display Balance Power Serial By-Pass Network Reset <li style="color: blue;">▶ Info 	<p style="color: blue; margin: 0;">Global Settings</p> <ul style="list-style-type: none"> Display : 100 % Balance : +0 dB Power : Auto Start <input checked="" type="checkbox"/> On <li style="padding-left: 20px;">: Auto Off <input type="checkbox"/> Off By-Pass : No Input <li style="padding-left: 20px;">: DC Servo <input checked="" type="checkbox"/> On Serial : RS232 <input type="checkbox"/> Off
---	--

Home
Back
Mute
Prev
Next

Channel settings for the currently selected input channel are listed on page 2:

Global Settings - Info (2 of 4)

<ul style="list-style-type: none"> Display Balance Power Serial By-Pass Network Reset <li style="color: blue;">▶ Info 	<p style="color: blue; margin: 0;">Channel Settings</p> <ul style="list-style-type: none"> Offset : +0 dB DC Servo : <input type="checkbox"/> Off Name : Line Input 3
---	---

Home
Back
Mute
Prev
Next



Tip

- The **Info** key is always available on the main screen of the display in the normal operating mode. Press this key to get directly to info page 2 as a shortcut to check the current channel settings of the selected input channel.

The info page 3 provides additional information on the HUMBOLDT and its software:

Device	Name of the device.
Firmware	Version number of the firmware.
Bootloader	Version number of the bootloader.
Font / Gfx	Version number of fonts and graphics.
Network	Version number of the network module.

Global Settings - Info (3 of 4)

Display	▶ Device Info
Balance	
Power	
Serial	
By-Pass	
Network	
Reset	
▶ Info	

Home Back Mute Prev Next

Information on the current network connection is available on info page 4:

- Mode** Current operating mode of the network module:
Infrastructure Mode: connects to the selected wireless network (see section 'Connecting to a wireless network' on page 56).
Access Point Mode: network module provides a stand-alone access point (see section 'Setting up the Access Point Mode' on page 58).
- Connection** Whether a network connection is established or not.
- MAC** MAC-Address of the Device.
- IP** IP-Address of the Device.
- DHCP** If the Dynamic Host Configuration Protocol (DHCP) is active or inactive.

Global Settings - Info (4 of 4)

<ul style="list-style-type: none"> Display Balance Power Serial By-Pass Network Reset <li style="color: #00aaff;">▶ Info 	<p style="color: #00aaff; margin: 0;">Network Info</p> <p>Mode : Infrastructure Mode</p> <p>Connection : established</p> <p>MAC : 00:18:af:34:c9:ba</p> <p>IP : 192.168.178.32</p> <p>DHCP : On ●</p>
--	---

Home
Back
Mute
Prev
Next

7.2 Channel settings: Options

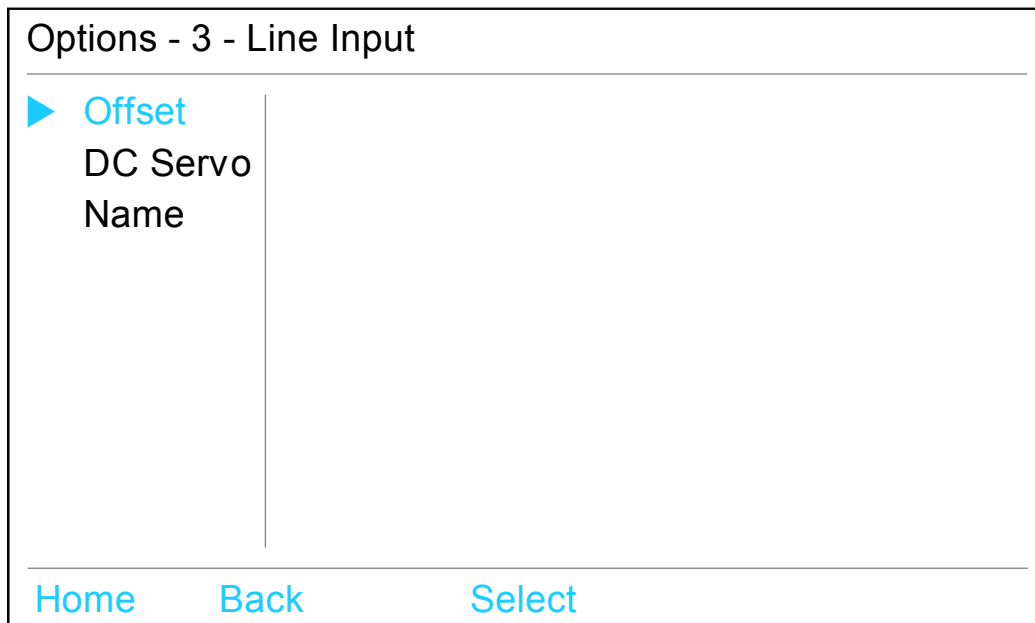

7.2.1 Offset

Turn the rotary encoder ② clockwise to increase the input level of the current channel. To decrease the input level, turn the rotary encoder counter clockwise instead. The display informs on the selected value in dB as well as with a bar graph:

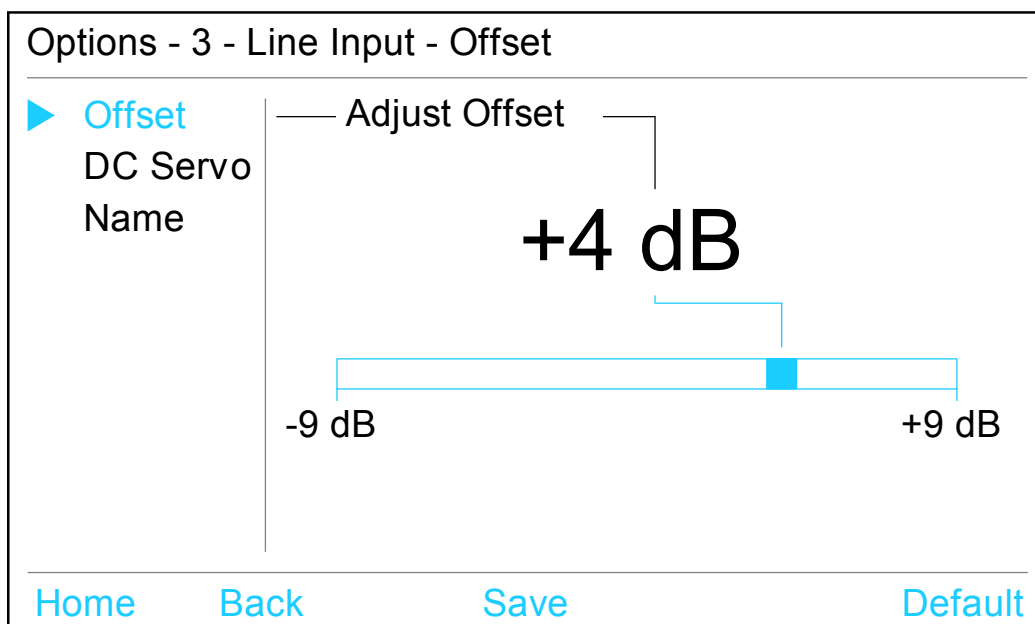

The adjustment of the input level may be defined individually for each of the six input channels of the HUMBOLDT. The range varies from -9 dB to $+9$ dB in steps of 1 dB. The offset function is used to achieve a matching volume in case of different output levels of the various sources connected to the HUMBOLDT.

7.2.2 DC Servo

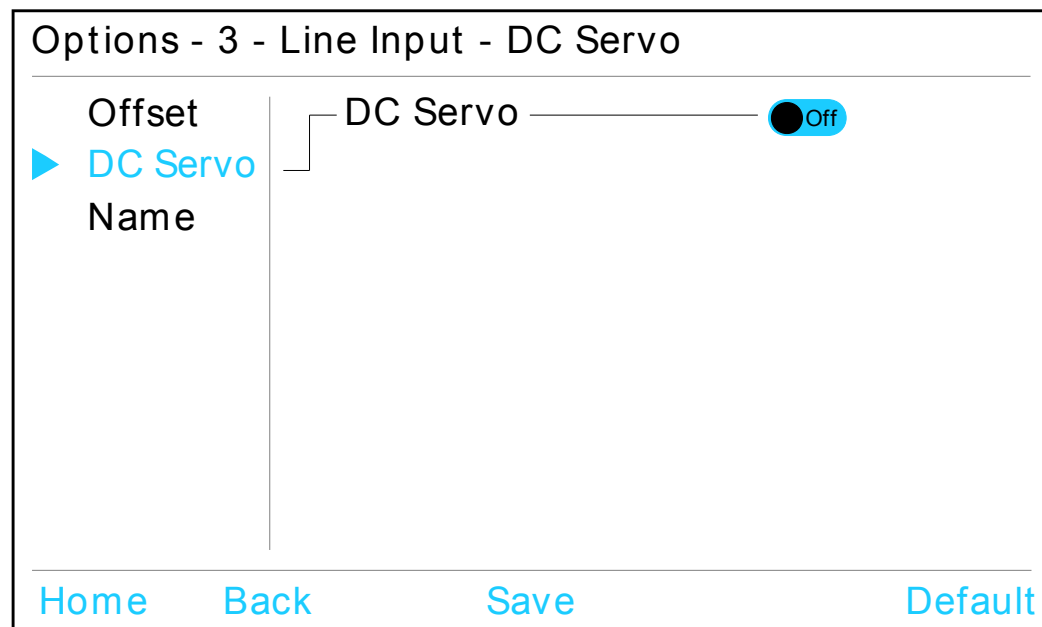

Turn the rotary encoder ② on the front panel clockwise to activate the DC Servo for the currently selected input channel. Turn it counter clockwise to disable the DC Servo.

Off The DC Servo is disabled for the currently selected input channel.

On The DC Servo is active for the currently selected input channel.

Activate the DC Servo if the source connected to the HUMBOLDT holds a high DC component in its output signal. The DC Servo eliminates the DC component. The currently selected input channel is now AC-coupled. Usually the DC Servo should be disabled.

7.2.3 Name

You can assign a fully user-definable name containing up to 12 characters in length to each of the six input channels. The display will show the number of the currently selected input channel as well as the assigned channel name. The cursor marks the character which you now may alter.

Use the rotary encoder **2** to select the desired character. Push the **Next** key to advance the cursor to the next character position to the right. Push the **Prev** key instead to move the cursor one position to the left. After the last or the first position, the cursor wraps around and starts at the first or last position again.

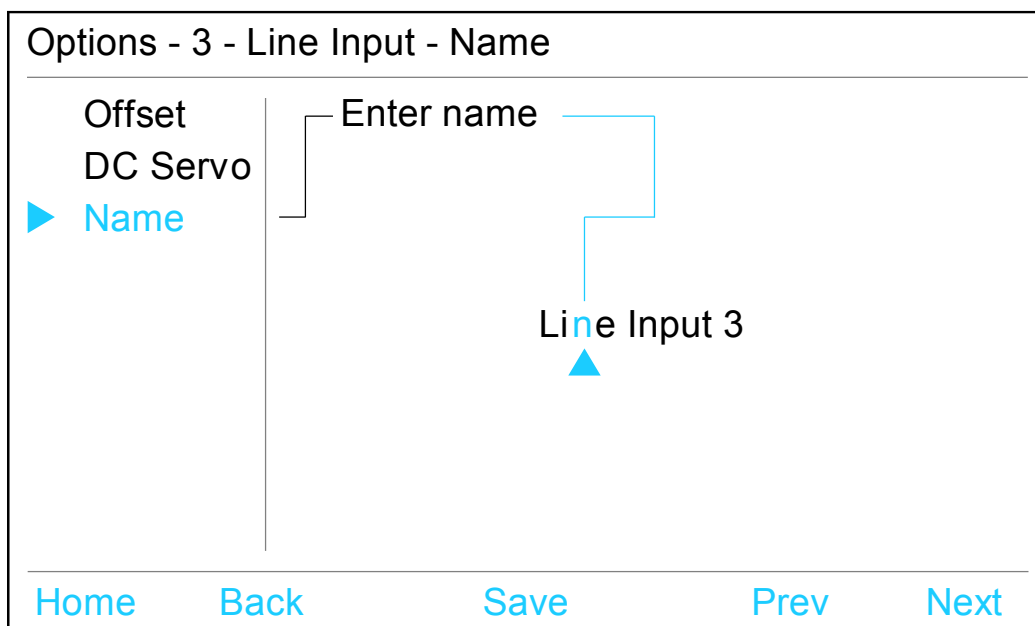

7.3 Overview of factory defaults

Option	Setting
Global settings:	
Display	100 %
Balance	0 dB
Auto Start	Off
Auto Power Off	Off
Input for By-Pass	0 - no input
DC Servo for By-Pass	On
Wireless	On
Channel settings:	
Offset	0 dB (for all inputs)
DC Servo	Off (for all inputs)
Name	1: Balanced In 1 2: Balanced In 2 3: Line Input 3 4: Line Input 4 5: Line Input 5

8 Audionet Metal Remote Control

The Audionet Metal Remote Control controls all important functions of the everyday use of your HUMBOLDT. This chapter explains all commands in detail.

8.1 Key assignment

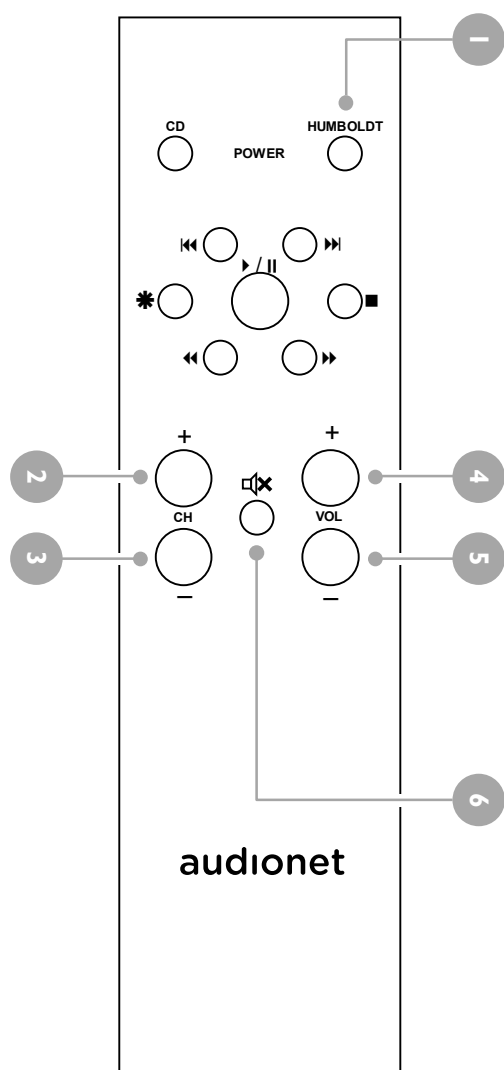

1 Power key HUMBOLDT

Use the key 'HUMBOLDT' to switch the HUMBOLDT on or off. This key has the same function as the  key on the front panel. If the unit is in stand-by mode, use the 'HUMBOLDT' key to turn it on. If the HUMBOLDT is already operating, a push on the 'HUMBOLDT' key powers the unit down to stand-by.

2 Key CH +

Selects the next input channel of the HUMBOLDT.

3 Key CH -

Selects the previous input channel of the HUMBOLDT.

4 Key VOL +

Increases the volume of the HUMBOLDT.

5 Key VOL -

Decreases the volume of the HUMBOLDT.

6 Mute key

Mutes the HUMBOLDT. Press this key again to resume to the last volume level.

8.2 Changing the batteries

First you have to remove the 6 Allen key head screws on the bottom side of your Audionet Metal Remote Control in order to change the batteries.

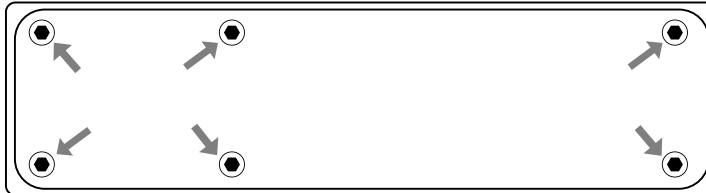

The battery compartment is to the left side of the circuit board. Two batteries type 'AAA' or 'Micro' with a voltage of 1.5 V are needed.

Battery compartment

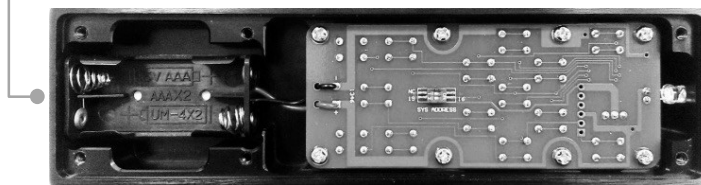

Important

- While inserting the batteries, please mind their orientation. The correct orientation is printed onto the bottom of the battery compartment.

8.3 Settings for Audionet preamplifier

The Audionet Metal Remote Control has 6 keys to control an Audionet (pre-)amplifier like the HUMBOLDT. The previous section 'Key assignment' explains the function of these keys.

Depending on their type, Audionet (pre-)amplifiers use different system addresses for their remote control code. A DIP switch on the circuit board of the Audionet Metal Remote Control selects the desired system address.

You have to open the remote control first in order to change the system address (compare the previous section 'Changing the batteries').

The DIP switch for selecting the system address of the Audionet Metal Remote Control is located here:

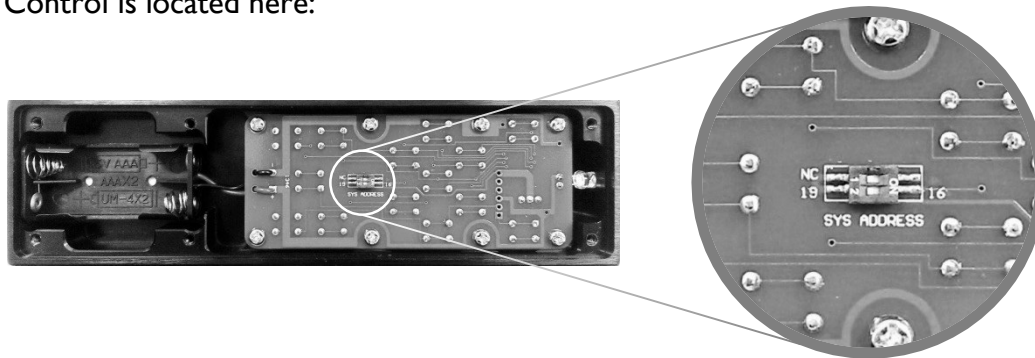

Set the DIP switch labelled 'SYS ADDRESS' in position '19' or '16' according to the following table:

Audionet preamplifier	Address
HUMBOLDT, WATT, SAM G2, SAM 20 SE	
STERN, PRE G2, PRE I G3, DNA, DNP, DNA I	19
MAP I	16



Note

- The Audionet Metal Remote Control is preconfigured to setting '19' of the DIP switch if not ordered explicitly otherwise.
- Older Audionet preamplifier models use the system address '16'.

9 AN-Ultimates Control App

It is possible to control the HUMBOLDT via app by using the wireless network connection. The AN-Ultimates app for iOS is available for download at the Apple iTunes app store. Please refer to the documentation of your Apple device if you need further information on how to access the iTunes app store or how to install the app.



Important

- In order to connect the AN-Ultimates app to the HUMBOLDT, the wireless network of the HUMBOLDT has to be enabled (see section 'Network' on page 39). Set the option 'Wireless' to 'On'.
- Please refer to section 'Network setup' on page 56 to configure the HUMBOLDTs connection to the wireless network in your home.

The main screen of the AN-Ultimates app consists of control elements to adjust the volume of the HUMBOLDT and to select the desired input channel.

To select an input channel, tap on the desired button. The names on the buttons correspond to the names of the inputs of the HUMBOLDT. The currently selected input is marked blue.

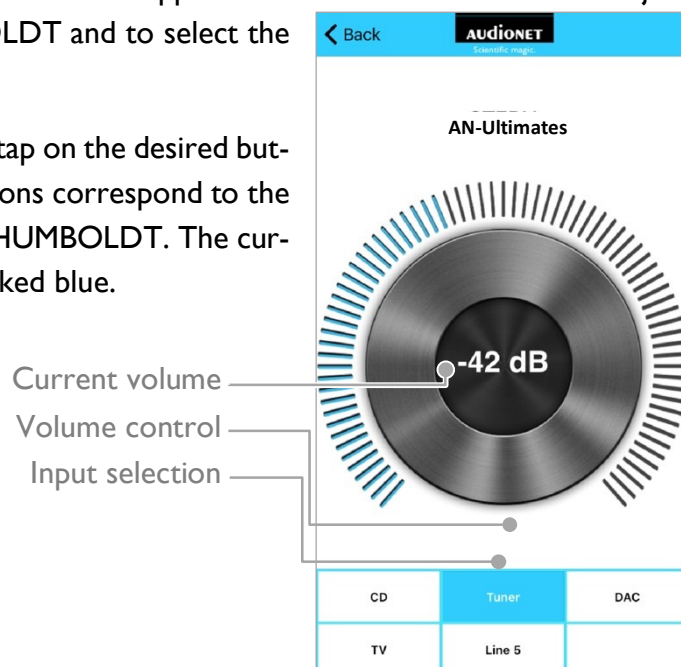

To adjust the volume level, slide your finger over the volume control on the screen. Move clockwise to increase the volume, move anti-clockwise to decrease the volume. The current volume level is displayed in 'dB'.

10 Network setup



Important

- Please make sure that the wireless network is enabled if you want to use the wireless networking features of the HUMBOLDT. Refer to section 'Network' on page 39. Set the option 'Wireless' to 'On'.



Note

- At the first start-up of the HUMBOLDT or after resetting the network to factory defaults (see section 'Reset' on page 43) the HUMBOLDT provides a wireless network of its own (a so-called Access Point). The name of this network is 'AudionetHUMBOLDT'. You will find it in your iPhone/iPad wireless settings.
- Please refer to section 'Connecting to a wireless network' below if you want the HUMBOLDT to connect to an existing wireless network.
- If you want to use the HUMBOLDT's access point, please see section 'Setting up the Access Point Mode' on page 58.

10.1 Connecting to a wireless network

1. Make sure the wireless network of the HUMBOLDT is activated (refer to section 'Network' on page 39).

2. Go to the wireless network (WLAN) settings of your iPhone/iPad and look for the wireless network 'AudionetHumboldt'.

3. Connect to the 'AudionetHumboldt' network.

4. Start the AN-Ultimates app. It will connect to the HUMBOLDT and present you the list of wireless networks in your vicinity.

You may now choose from this list, which wireless network you want to connect to.



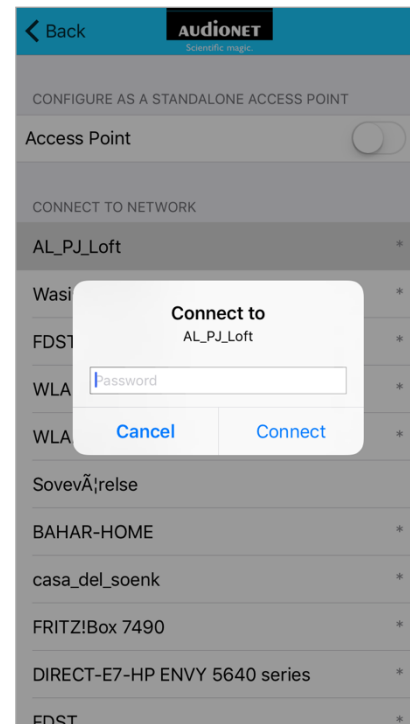
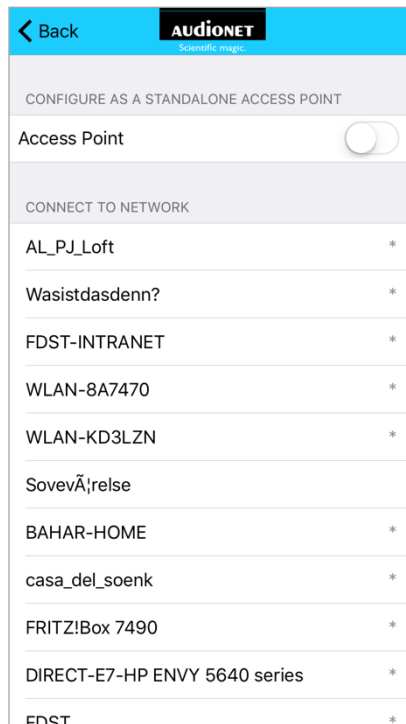

Note

- In case you prefer the HUMBOLDT providing its own wireless network, see section 'Setting up the Access Point Mode' on the next page.
5. Depending on the security settings of the selected wireless network, you are prompted to enter a passphrase. Please refer to the settings of your wireless network for the correct passphrase.
 6. Tap 'Connect' and the HUMBOLDT will connect to the selected wireless network.
 7. Go to the wireless network settings of your iPhone/iPad and log in to the same wireless network as chosen in step 4. The AN-Ultimates app will recognize the HUMBOLDT afterwards and connect to it automatically.
 8. You are now ready to use the AN-Ultimates app to control the HUMBOLDT (see section 'AN-Ultimates Control App' on page 55).

10.2 Setting up the Access Point Mode

The HUMBOLDT will act as an access point by factory default, e.g. providing its own wireless network that your iPhone/iPad may connect to.

This enables you to use the AN-Ultimates app without any other routers or access points.

1. Make sure the wireless network of the HUMBOLDT is activated (see section 'Network' on page 39).
2. Go to the wireless network settings of your iPhone/iPad and look for the wireless network 'AudionetHumboldt'.
3. Connect to the 'AudionetHumboldt' network.
4. Start the AN-Ultimates app. It will connect to the HUMBOLDT and present you a list of wireless networks in your vicinity. Choose the item 'Access Point' from this list.
5. The HUMBOLDT is now configured to Access Point mode. You may use the AN-Ultimates app now.

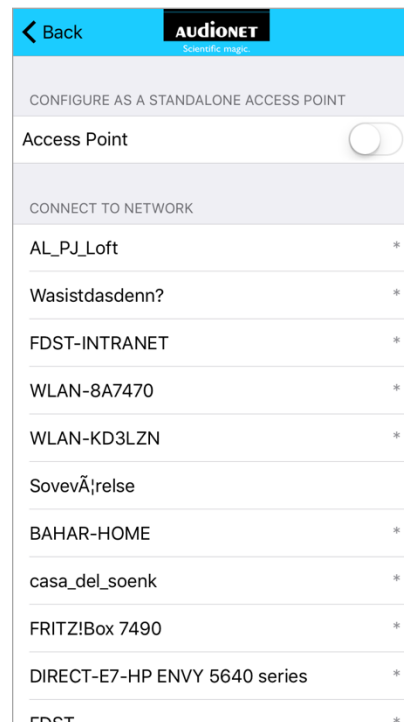

The configuration process is completed.

The HUMBOLDT will be activated in Access Point Mode automatically on the next start-up.

10.3 Network trouble shooting

In case the HUMBOLDT is not able to connect to the selected wireless network, the display of the HUMBOLDT will inform you about the problem. This might occur most likely if a wrong passphrase is entered during the initial setup or if

the access point that is providing the selected wireless network is powered down / not available.

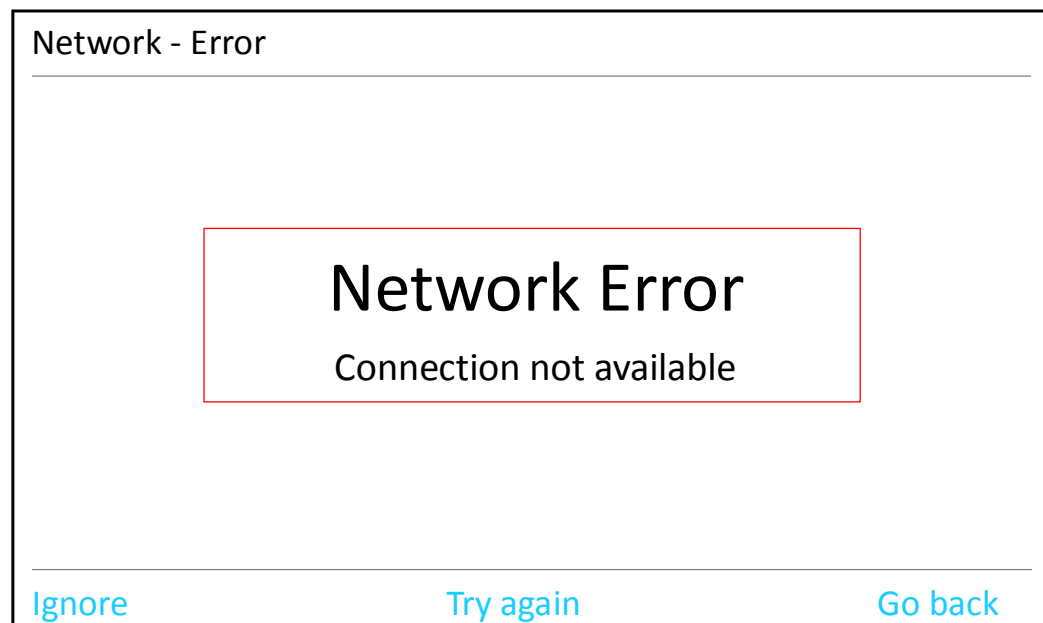

You have 3 choices to continue:

- Ignore** By using this option, you ignore the error and continue working with the HUMBOLDT. This will be usually the case, if you know the preferred wireless network is down and you want use the HUMBOLDT with the remote control and front panel control elements in the meantime. You may always restart or reset the network connection later (see section below).
- Retry** Choose this option if you want to retry to establish a connection with the current settings. This is the case if you don't want to change the settings, but you need to repeat the connection attempt, maybe because your router / access point was not fully up and running at the time the HUMBOLDT tried to connect to it.
- Go back** Choose this option if you want to go back to the factory defaults and select a new wireless network and/or enter the correct passphrase. Use this option if the connection fails at initial setup. The HUMBOLDT will go back to Access Point mode providing the wireless network 'AudionetHUMBOLDT'. If connected to this network, the AN-Ultimates app will offer you the list of wireless

networks again. You may now choose the network and are able to enter the correct passphrase (see section 'Connecting to a wireless network' on page 56).



Important

- If you choose to ignore the error message and continue working with the HUMBOLDT, you will be able to select one of the other choices ('Retry' or 'Go Back') listed above at any time from the menu.
- If you want to retry to log onto the selected wireless network, press the 'Menu' button on the main screen of the HUMBOLDT. Then select the menu item 'Network' and afterwards the sub-item 'Connection'. Now use the button 'Re-Connect'. The HUMBOLDT tries to reconnect to the selected wireless network. Also refer to section 'Network' on page 39.
- If you would like to go back to the factory defaults and choose a different wireless network or re-enter a passphrase, press the 'Menu' button on the main screen of the HUMBOLDT. Then select the menu item 'Reset' and the sub-item 'Reset Network' (see section 'Reset' on page 43). After confirming the reset process, the HUMBOLDT will reset the network settings to the factory defaults thus allowing you to setup the wireless network with the AN-Ultimates app as described above in the section 'Connecting to a wireless network'.

10.4 Updating the HUMBOLDT

If the HUMBOLDT is connected to a wireless network that provides access to the internet, the AN-Ultimates app will automatically search for updates on the Audionet Server.

In case an update is found, the AN-Ultimates app will inform the user and offer the choice to update the HUMBOLDT.

If you agree to the update, the AN-Ultimates app will download the necessary files and store them into the internal memory of the HUMBOLDT. When all files are safely transmitted, the actual update process is started. The display of the HUMBOLDT informs the user of the progress of the update process.

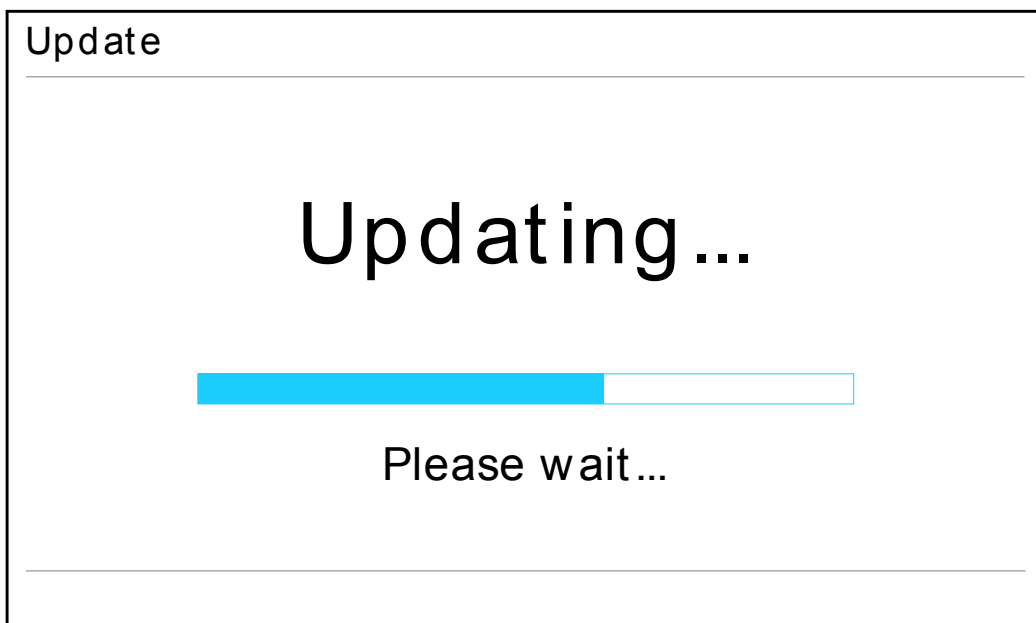
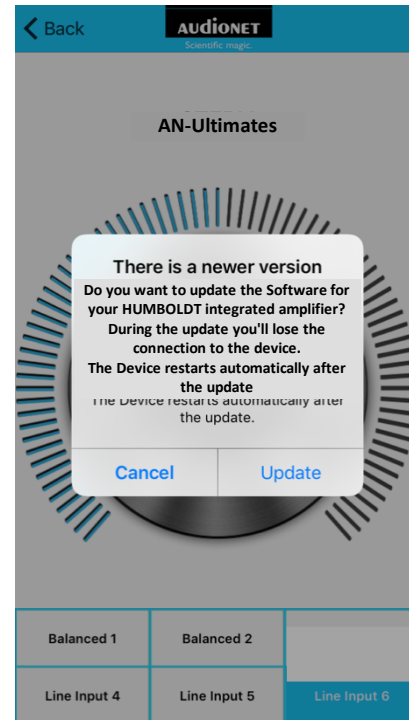

In case you choose not to update this time, the AN-Ultimates app will remind you about it later.



Important

- Do not disconnect the HUMBOLDT from mains power while the update process is running.
- The HUMBOLDT must be connected to a wireless network that has access to the internet, so that the AN-Ultimates app is able to access the Audionet Server to check for updates and to download the necessary files.



Note

- The AN-Ultimates app is disconnected from the HUMBOLDT during the update process and music playback is not possible. After the update process is finished, the HUMBOLDT will start-up again automatically.

II Protection system

The Audionet HUMBOLDT as well as the loudspeakers are protected by a complex protection circuitry. The display informs about the nature of the detected problem in plain text in case of a malfunction.

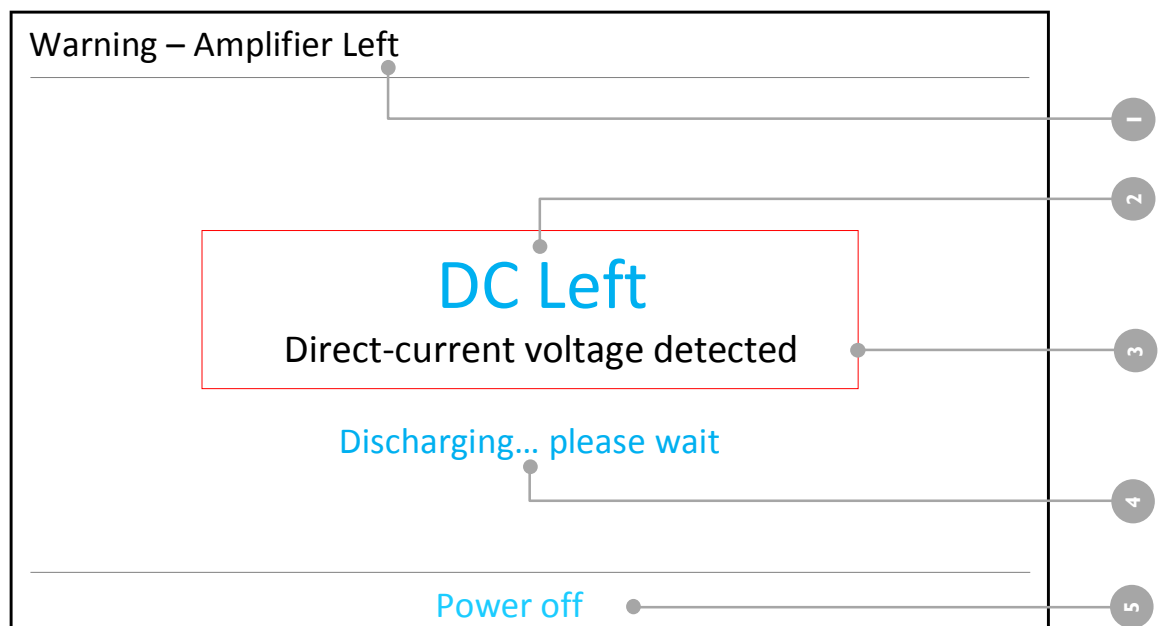

- 1 Location of detected error
- 2 Detected error
- 3 Short description of detected error
- 4 Discharging notice
- 5 After discharging press key to continue to stand-by mode



Important

- As soon as an error is detected by the protection system, HUMBOLDT powers down. The display **4** gives information about the nature of the error. After the discharging is completed, the error message will still be in the display. To continue to stand-by mode, press the middle key beneath the display or the **⏻** key **1** on the front panel.
- Remove the cause of the error prior to switching the HUMBOLDT on again!

The following table is an overview on all detectable faults and their possible causes:

Error	Possible causes
Overload	Short circuit or defect in loudspeaker.
DC	High level of DC voltage at the output: defective preamplifier or source unit.
HF	High frequency oscillation: defective preamplifier. Clipping: amplifier or preamplifier are overdriven.
Overtemperature	HUMBOLDT is getting too hot. Cooling slots covered.
Pre Voltage	Fuse blown or different fault in power supply (pre voltage): service case.
Amplifier Voltage	Fuse blown or different fault in power supply (amplifier voltage): service case
Power Voltage	Mains voltage is out of the permitted range of +/- 17% of nominal mains voltage; the unit switches off for security reasons or does not start up.
Power Failure	(Short) blackout of mains power.

11.1 Monitoring mains power voltage

During operations the HUMBOLDT monitors the mains power voltages. In case of sudden loss of mains, the HUMBOLDT shuts down all outputs to avoid harmful noise on the outputs due to the unexpected loss of mains power.

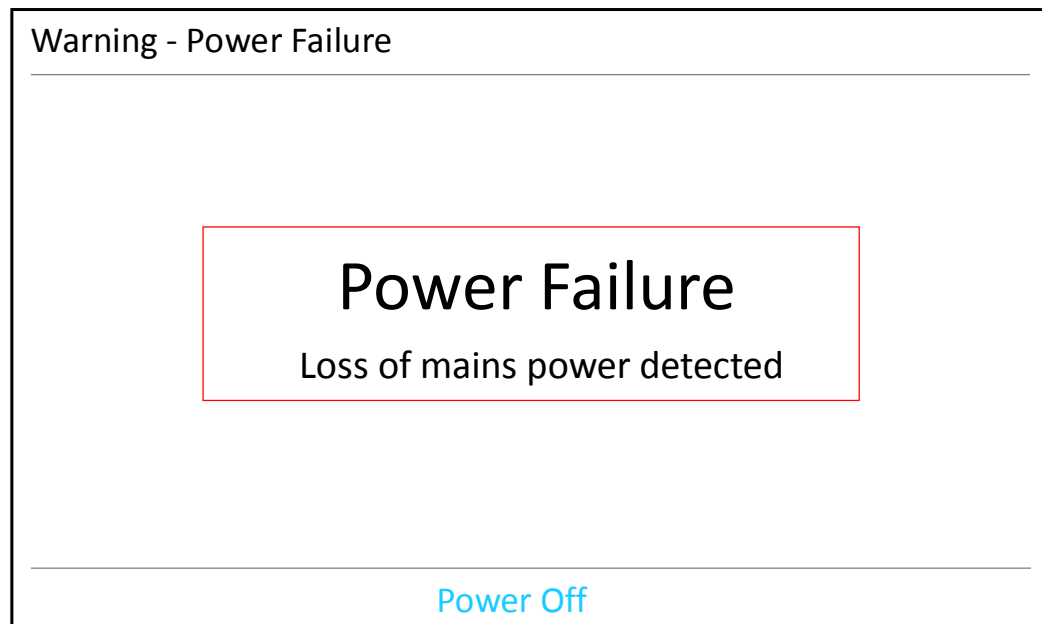

After a short drop-out of mains power you might read the warning 'Power Failure'. In this case press 'Power off' on the front panel to continue. The HUMBOLDT will now enter stand-by mode. If the mains power is stable again you may restart the HUMBOLDT.

While switching on from stand-by mode and during operations the HUMBOLDT also monitors the level of mains power voltage. In case the mains power voltage level is out of the permitted range during switching on or for a longer period during operations (so that a secure operation of the unit is no longer ensured), the HUMBOLDT will shut down for security reasons issuing the warning 'Power Voltage'.

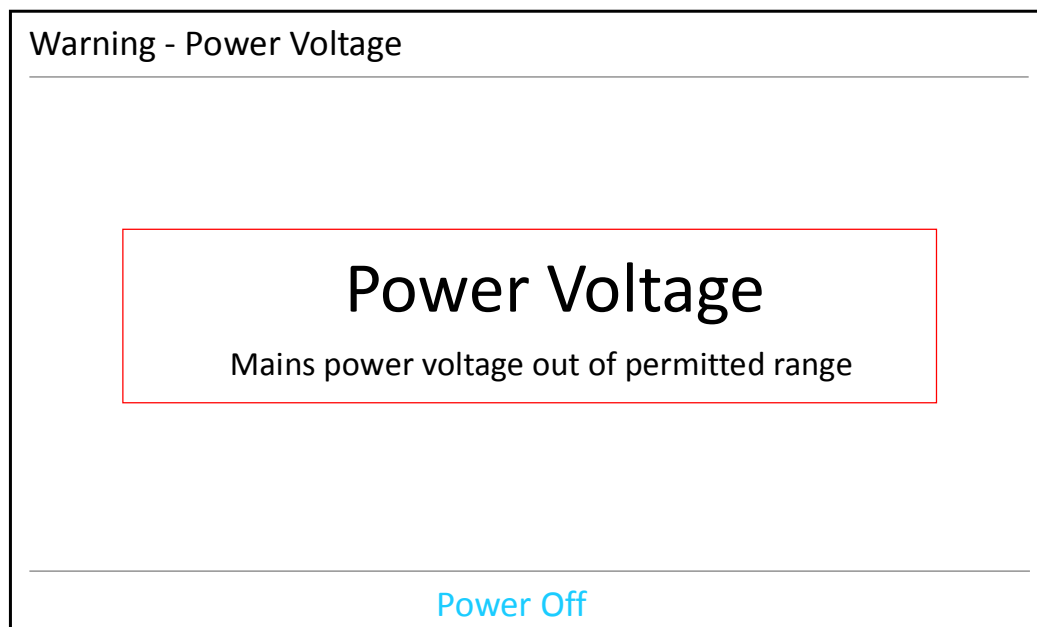

Press key 'Power off' on the front panel to continue. The HUMBOLDT is now in stand-by mode. If the mains power voltage level is back inside the permitted range, you may start up the unit again.

12 Security advice



Important

- Avoid packaging material, especially plastic bags, coming into children's hands!
- Only store and operate the unit in a dry room at a reasonable room temperature!
- Avoid moisture, any liquids, dirt or small objects of getting into the unit!
- Set the unit up in a sufficiently ventilated environment!
- Do not cover the unit!
- Do not open the unit. Unauthorised opening will void warranty!
- Do not short-circuit the outputs!
- While connecting or removing the HUMBOLDT to or from sources and/or speakers, all units have to be switched off to prevent any damage of the HUMBOLDT or the other connected units.
- Use a dry cloth for cleaning!

We do wish you many exciting listening experiences with your new Audionet device.

If you still have any questions, do not hesitate to ask your Audionet retailer or contact us directly.

13 Technical information

Special features of the HUMBOLDT:

- Double mono setup of input, volume control and power amplifier sections as well as power supply for a maximum of channel separation
- Magnetically and capacitively optimized circuit and device design without any ferro-magnetic materials.
- Floating Panel Design for optimal resistance against microphonic effects and temperature stability.
- The floating panels of the body are resonance-optimized by pads on an aluminum frame.
- Mounting and bolted assembly of transformers made of stainless steel.
- Air Flow Design circuit boards for an optimum of cooling and stable quiescent currents.
- Galvanic separation of all analog circuits by opto couplers.
- Rhodium Cinch jacks and speaker terminals by Furutech.
- Volume controller on a double ball-bearing axis and with magnetic ratchet and optical sensing.
- Volume controlled by electronic switches and real-time linearized precision resistor network.
- DC coupled with no sound diminishing capacitors or coils, shortest signal paths.
- Two separate transformers per channel for channel separated power supplies (double mono setup).
- In total two 100 VA and two 850 VA toroid transformers, all encapsulated and decoupled
- Main power supply capacitors for power amplifiers 312,000 μF , optimized for very low impedance.
- Total capacitance of 400,000 μF .
- Microprocessor control with separate power supply monitor and control of all functions, informing the user on a high-resolution display.

- By-Pass mode for integration into home cinema systems.
- Audionet Link outputs for the remote control of further Audionet devices.
- User definable names for each input, input levels adjustable for each input.
- User selectable function to remove DC levels from signal sources.
- Rhodium fuse.
- Preamplifier outputs (Cinch and XLR balanced) to connect further power amplifiers or subwoofers.

I4 Technical data

Type	Ultimate Analog Integrated Stereo Amplifier
Output power	2 x 250 W into 8 Ω 2 x 380 W into 4 Ω
Frequency response	0 - 700,000 Hz (-3 dB), DC coupled 0.3 - 700,000 Hz (-3 dB), AC coupled
THD+N	<-100 dB @ 1 kHz
SNR	> 120 dB, (A-weighted)
Channel separation	>140 dB, 20–20,000 Hz
Inputs	3 pair RCA line, Rhodium (Furutech) 2 pair XLR balanced, gold plated (Neutrik) 1 D Sub 9 serial port (control only) 1 SMA for WLAN (control only)
Outputs	2 pair speaker terminals, Rhodium (Furutech) 1 pair RCA line, Rhodium (Furutech) 1 pair XLR balanced, gold plated (Neutrik) 2 Audionet Link, optical 1 connector, gold plated, for additional earth connection
Output impedance	Line input: 50 k Ω XLR input: 35 k Ω
Mains	220..240 V or 110..120 V, 50..60 Hz
Power consumption	< 0,5 W stand by, max. 1800 W
Dimensions	width: 450 mm height: 320 mm depth: 505 mm
Weight	60 kg

Finish	plates:	aluminum, 9 mm, pearl blasted, silver or black, text and icons printed black or white
	display:	color TFT
	chassis:	brushed aluminum, black anodized

Errors and omissions excepted. Specifications and design are subject to changes without prior notice.

AUDIONET

audionet GmbH

Brunsbütteler Damm 140 B

13581 Berlin

Germany

en.audionet.de

contact@audionet.de

AUDIONET

Scientific magic.



Audionet is a registered trademark of
audionet GmbH

Brunsbütteler Damm 140 B
13581 Berlin
Germany

www.en.audionet.de

 Audionet