



# OWNER'S MANUAL

## **SI-300.2d**

Digital Integrated Amplifier

NOTE: Before installing your new component, please read this manual carefully as it will inform you of the product specifications, proper installation and correct operating procedures for your unit. Also included in this manual are guidelines on how to service and care for your new Cary Audio Design product.

# TABLE OF CONTENTS

---

<b>Important Safety Instructions</b> .....	3
<b>Welcome</b>	
Thank You .....	5
<b>Installation</b>	
Unpacking .....	6
Warranty Card .....	6
Placement .....	7
<b>Features</b>	
Product Features.....	8
<b>Controls and Displays</b>	
Front Panel.....	9
Rear Panel.....	11
Remote Control.....	13
App Control for iOS and Android (Future).....	13
<b>Menu Operation</b>	
Setup Menu Overview.....	14
Procedures for Navigating Ethernet and Wi-Fi Sub Menus .....	14
Setup Menu – Expanded View and Functions.....	15
Network Ethernet and Wi-Fi Setup (From DAC) .....	16
Network Wi-Fi Setup (From APP).....	20
<b>Maintenance Functions</b>	
Maintenance Functions .....	21
<b>General Operation</b>	
Power On/Off.....	22
Speaker Connections .....	22
Source Connections.....	22
Switching Inputs .....	22
Muting the Sound.....	22
VU Meters.....	22
<b>Digital Input Operation</b>	
Using the Analog Inputs .....	23
Cinema Bypass Function .....	23
Using the SPDIF Inputs .....	24

# TABLE OF CONTENTS

---

## **USB Operation**

USB Requirements .....	25
PC Driver Installation.....	25
Macintosh USB Audio Setup .....	25
USB Audio Playback.....	26
USB DSD Playback.....	26

## **BLUETOOTH Operation**

BLUETOOTH Connection.....	27
BLUETOOTH Playback .....	27

## **TruBit™ Upsampling Operation**

PCM to DSD Conversion and Upsample Rate Converter Function.....	28
---	----

## **Specifications**

Amplifier Specifications.....	29
Analog Inputs .....	29
Digital Inputs.....	29
Digital Outputs.....	29
Digital Specifications.....	30
General Specifications.....	30
USB Playback (PCM & DSD) .....	30
SPDIF Playback (PCM) Coaxial, Toslink, AES/EBU .....	31

## **Service and Care**

Care and Cleaning .....	32
AC Power Fuse Replacement.....	32
Factory Service .....	32
Non-Warranty Repairs .....	32

<b>Limited Warranty</b> .....	33
-------------------------------	----

# IMPORTANT SAFETY INSTRUCTIONS

---

**WARNING:** The triangle with the lightning flash symbol displayed on the unit advises the user of dangerous un-insulated voltage inside the product's enclosure.

**CAUTION:** To reduce the risk of electric shock, do not remove the cover. There are no user-serviceable parts inside; it is recommended that only qualified personnel service this component.



**ALERT:** The triangle with the exclamation point symbol on the component suggests that the owner refer to important operating and maintenance instructions in the owner's manual.

1. **OWNER'S MANUAL:** Before powering up the equipment, read all safety and operating instructions and follow them as instructed. Retain the safety and operating instructions for future reference.
2. **ATTACHMENTS:** Use only those attachments recommended by the unit manufacturer, as others may cause hazards.
3. **ACCESSORIES:** Do not place the unit on an unstable cart, stand, tripod, bracket, or table. The unit may fall, causing injury to a person or damage to the unit. Mount the unit according to the manufacturer's instructions with the suggested mounting accessory.
4. **WALL OR CEILING MOUNTING:** Mount the unit to a wall or ceiling only in the manner recommended by the manufacturer.
5. **WATER AND MOISTURE:** Do not use the unit near water (for example, near a swimming pool, bath tub, wash bowl, kitchen sink, or laundry tub) or in a damp environment (like a basement or outside in the rain).
6. **OBJECT AND LIQUID ENTRY:** Do not push objects of any kind into the unit through openings as they could touch dangerous voltage points and short-out parts, possibly resulting in a fire or electric shock. Avoid spilling liquid of any kind on the unit. If water or any metal object (such as a paper clip, coin, or staple) accidentally falls inside the unit, disconnect it from the AC power source immediately and contact Cary Audio Design for further instructions.
7. **HEAT:** Position the unit away from heat sources such as radiators, heat registers, stoves, or other units (including amplifiers) that produce heat.
8. **VENTILATION:** Slots and openings in the cabinet create ventilation to protect the component from overheating. These openings on the top and bottom panels must remain unobstructed. Allow at least 6 inches (16cm) of clearance above the unit and an opening behind the unit for airflow. Do not place the unit on a bed, sofa, rug, built-in bookcase, or rack without adequate ventilation.
9. **GROUNDING OR POLARIZATION:** As a safety feature, the unit may be equipped with a polarized alternating current line plug in which one blade is wider than the other. This plug will fit into the power outlet only one way. If you cannot insert the plug fully into the outlet, try reversing the plug. If the plug still will not fit, contact a licensed electrician to update your obsolete outlet. Do not defeat the safety purpose of the polarized plug.
10. **POWER SOURCES:** Operate the unit only from the power source indicated on the marking label. If you are unsure of the type of power supplied to your home, consult your unit dealer or local power company.
11. **POWER CORD PROTECTION:** Arrange power supply cords so that they do not suffer from foot traffic or pinching by items placed on or against them. Pay close attention to cords where plug enter the AC outlet and where they exit from the unit.
12. **LIGHTNING:** For added protection during a lightning storm or when the component is idle for long periods of time, unplug the unit from the wall outlet and disconnect the antenna or cable system. This will help protect the unit from lightning and power line surge damage.
13. **POWER LINES:** Do not locate an outside antenna system in the vicinity of overhead power lines or other electric light or power circuits. When installing an outside antenna system, take extreme care to avoid touching the power lines or circuits; contact with them could be fatal.
14. **OVERLOADING:** Do not overload wall outlets, extension cords, or integral convenience receptacles as this increases the risk of fire or electric shock.
15. **REPLACEMENT PARTS:** When replacement parts are required, be sure the service technician has used replacement parts specified by the manufacturer or those having the same characteristics as the original parts. Unauthorized substitutions may result in fire, electric shock or other hazards.
16. **SAFETY CHECK:** Upon completion of any service or repairs to the unit, ask the service technician to perform safety checks to ensure the unit is in proper operating condition.

# IMPORTANT SAFETY INSTRUCTIONS

## 17. IMPORTANT SAFETY NOTE:

- Before connecting a new product such as the Cinema 12 to your audio or home theater system, turn off all other equipment (preferably unplugging them from the AC power source). Many audio components feature automatic turn-on circuits that may activate during an installation, potentially causing damage to electronic components and/or speakers. This type of damage is not covered by product warranties, and Cary Audio specifically disclaims responsibility for any such damage.
- **Power Cord:** The removable power cord provided with your unit was specifically designed for use with this product, but other AC cords may be used. Consult your dealer for advice on AC power cords and high quality wire in your system.
- **AC Fuse:** The fuse is located inside the chassis and is not user serviceable. If the unit does not power up, contact an authorized service representative
- **Wiring:** Cables running inside walls should have the appropriate markings to indicate compliance and listing by the UL, CSA or other standards required by the UL, CSA, NEC or your local building code. Questions about cables inside of walls should be referred to a qualified custom installer, a licensed electrician, or low-voltage contractor.



18. **RECORDING COPYRIGHT:** Recording of copyrighted material for other than personal use is illegal without permission of the copyright holder.

19. **NOTE TO CATV SYSTEM INSTALLER:** This reminder is provided to call the CATV system installer's attention to article 820-40 of the NEC, ANSI/NFPA 70, which provides guidelines for proper grounding and, in particular, specifies that the cable ground shall be connected to the grounding system of the building as close to the point of cable entry as practical.

## 20. FCC INFORMATION FOR USER:

- **CAUTION:** Any changes or modifications not expressly approved by Cary Audio Design could void the user's authority to operate the equipment.
- **NOTE:** This equipment has been tested and found to comply with the limits for a Class B digital device pursuant to Part 15 of the FCC Rules.
- These limits are designed to provide reasonable protection against harmful interference in a residential installation. This equipment generates and can radiate radio frequency energy, and if not installed and used in accordance with the instructions it may cause harmful interference to radio communications. However, there is no guarantee that interference will not occur in a particular installation. If this equipment does cause harmful interference to radio or television reception, which can be determined by turning the equipment off and on, the user is encouraged to try to correct the interference by one or more of the following measures:
  - Reorient or relocate the receiving antenna.
  - Increase the separation between the equipment and receiver.
  - Connect the equipment into an outlet on a circuit different from where the receiver is connected.



## 21. OUTDOOR ANTENNA INSTALLATION/SAFE ANTENNA AND CABLE CONNECTION:

- If an outside antenna or cable system is connected to the equipment, be sure the antenna or cable system is grounded in order to provide protection against built-up static charges and voltage surges. Article 810 of the National Electrical Code, ANSI/NFPA 70 (in Canada, Part 1 of the Canadian Electrical Code) provides information regarding proper grounding of the mast and supporting structure, grounding of the lead-in wire to an antenna discharge unit, size of grounding conductors, location of antenna discharge unit, connection to grounding electrodes and requirements for the grounding electrode.
- Outside antenna system should be located well away from power lines, electric light or power circuits and where it will never come into contact with these power sources if it should happen to fall. When installing an outside antenna, extreme care should be taken to avoid touching power lines, circuits or other power sources as this could be fatal. Because of the hazards involved, antenna installation should be left to a professional.

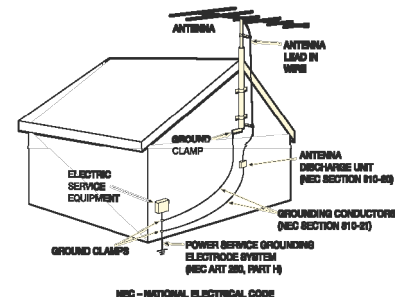

# WELCOME

---

## THANK YOU

### **Congratulations on becoming a Cary Audio owner!**

Cary Audio would like to thank you for purchasing our products.

Since its founding in 1989, Cary Audio has stayed at the forefront of home entertainment equipment by stubbornly adhering to the principles of quality and musicality upon which it was founded. It's not enough just to be able to build great sounding gear, but it needs to be well-made, reliable, and maintain its performance and value for many years. Cary Audio has certain criteria that have guided us since we began, and are still our primary focus.

We firmly believe in high performance products that offer incredible value for the money, backed by superior engineering and design, and supported by exceptional customer service. Whether a headphone amplifier or a world-class surround sound processor, Cary Audio uses the highest quality components available within the audio circuit, resulting in extraordinary sound quality. This is a well-known hallmark of all Cary Audio products.

For over a quarter century of providing the best in high performance music systems, Cary Audio remains committed to our goals of building the very best products, at real-world prices, and supporting them with world-class service. Let our passion for the very finest sound and picture quality help you better enjoy your music and movies! Thank you for your continued support!

Cary Audio

# INSTALLATION

---

## UNPACKING

This section describes the proper unpacking and installation procedures.

### Unpacking

All Cary Audio shipping cartons have been specially designed to protect their contents and special care has been taken to prevent damage under normal shipping conditions. Mishandling should be evident upon inspection of the shipping container. If shipping damage is found after visual inspection, take care not to destroy the evidence. If necessary, document the damage with photographs and contact the transport carrier immediately.

Carefully remove your new component from its packing carton and examine it closely for signs of shipping damage. We strongly recommend saving all original packing cartons to protect your component from damage should you wish to store it or ship it at a later date.

### Power Requirements

The SI-300.2d Digital Integrated Amplifier is designed to operate from AC main current. The AC voltage is either 110V-120V or 220V-240V AC at 50-60 Hz.

### In the Box

When unpacking your SI-300.2d, make sure the following accessories are included. You should find the following items within the box:

- Power Cable
- Owner's Manual
- Warranty Card
- Two Screws on Adjustable Angle Antennas

## WARRANTY CARD

**IN THE USA:** If you are the original purchaser of a new unit purchased from an authorized Cary Audio dealer or from CaryDirect.com, please fill out the enclosed warranty registration card and return it to Cary Audio within 15 days of your purchase. Cary Audio also suggests that you keep your original packing cartons in case you ever need to ship the unit. Warranty restrictions apply. Consult the warranty section at the end of this manual for details. Please be certain to keep a copy of the original sales receipt from your direct purchase from Cary Audio or your authorized Cary Audio dealer to validate the warranty if ever needed. The warranty is for the original purchaser only and does not transfer to any subsequent owner.

**OUTSIDE THE USA:** Your local authorized Cary Audio distributor will make its' own warranty policy for your country. Please check with them for the terms of warranty for your new product.

# INSTALLATION

---

## PLACEMENT

In general, the location of your new SI-300.2d is not critical. However, certain precautions must be taken to ensure optimum performance. Avoid extremely hot locations such as near radiator or other heating units. Keep the top of the SI-300.2d clear with plenty of ventilation to protect against overheating as the SI-300.2d can generate substantial heat.



# FEATURES

---

The following section describes the SI-300.2d basic features. Please read the Operation Section of this manual to learn more on utilizing these features. The features are subject to change without notice or obligation.

## TruBit™ DSD & PCM CONVERSION AND UPSAMPLING

Upsampling can be messy, leaving behind lots of digital artifacts resulting in noise and inaccurate signal generation. On the surface, upsampling may seem like a good idea. But if not implemented properly it can be disastrous. Many DACs use modest DSP chips at best, or worse, the DAC chip itself to upsample all incoming digital signals. Typically, this is done as a predefined *one-size-fits-all* sample rate, such as 96 kHz, 384 kHz, etc. On the contrary, Cary Audio's TruBit™ Upsampling is a sophisticated and powerful process utilizing a dedicated 128 bit DSP engine which allows for up to 10 different selectable TruBit™ sample rates and an increased bit depth of 32 bits for PCM and 1 bit for DSD. This allows PCM to be converted to DSD or lower DSD rates Upsampled to higher DSD rates. Working in tandem with our OSO™ Reclocking feature, the newly generated signal is cross-checked multiple ways ensuring that the selected upsample rate is as if it were an original native signal. The result is a signal free from digital artifacts that sounds accurate, pure, and a joy to listen to

## fi™ BLUETOOTH IMPLEMENTATION

Bluetooth modules are a fantastic and convenient way in which to share and listen to music from online and mobile sources. It's not unusual for companies to use such modules as a complete end-to-end or add on solution whereby using the cheap low-grade onboard DAC chips included in the modules and simply passing the analog signal of the module to the analog output section. Our solution is to *fully integrate (fi™)* the digital information of the CSR aptX® lossless Bluetooth receiver into the entire digital circuit of the SI-300.2d. This approach ensures that Bluetooth sources have the potential to sound like any other expensive input source whereby utilizing our sophisticated digital topology and our other integrated digital features such as; TruBit™ Upsampling, and OSO™ Reclocking,. Now your Bluetooth sources can truly be high *fi*.

## OSO™ RECLOCKING

Once a digital signal is transferred into Cary Audio's digital ecosystem via the digital inputs or CD, it is processed with extreme care to ensure the best possible sound achievable. As a digital source transfers from one point A to point B it creates an insidious digital problem called jitter. To deal with this, Cary Audio uses something we call OSO™ Reclocking. While USB Asynchronous inputs use the XMOS processor to control the clocking of the USB host, other non-USB sources don't have this luxury. Our solution is to re-clock all signals again once onboard, even XMOS USB, as to ensure all jitter is virtually eliminated to a minute degree. We call this OSO™, short for "Onboard Signal Origination" because this re-clocking and buffering creates a signal so stable and jitter free it's as if the origin of the signal was generated onboard and not from an external source.

## XMOS xCore USB ASYNCHRONOUS

XMOS is the de-facto standard in USB Audio 2.0. This design delivers bit perfect PCM audio up to 384kHz, DSD and DoP format support, round trip latencies as low as 3ms and use asynchronous clocking for computer USB sources. This means the SI-300.2d has complete control over the audio clock quality; essential for no-compromise digital audio systems.

# CONTROLS AND DISPLAYS

## FRONT PANEL

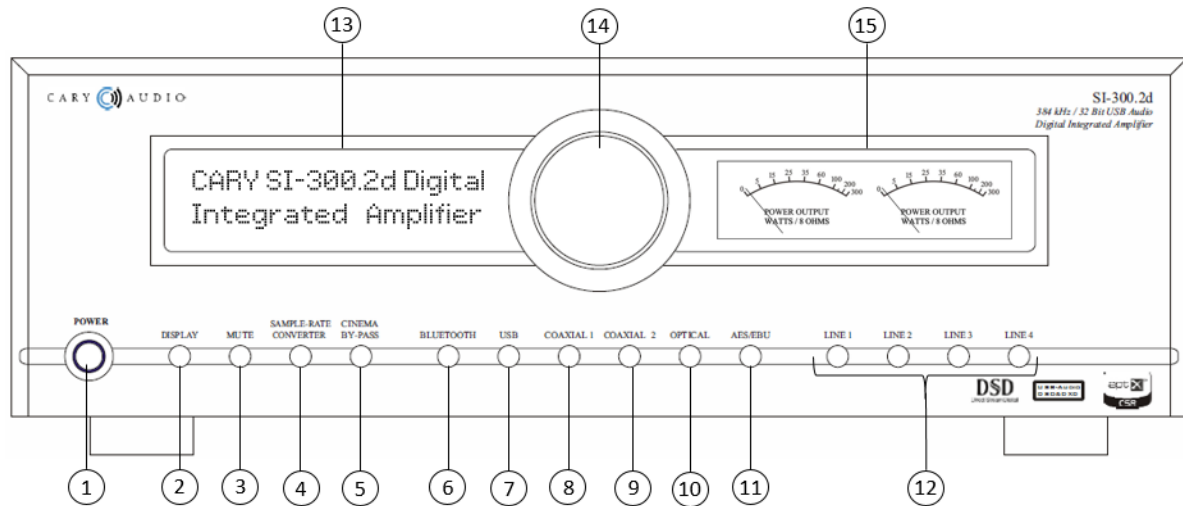

### 1. POWER

Press once to turn the power ON. The blue indicator ring will blink until the unit is ready to operate. Press again to turn the power off.

### 2. DISPLAY

Press to change the brightness level of the front panel display. Low-->Medium-->High-->Off

### 3. MUTE

Press to mute the output volume. Press again to disengage mute. When disengaging, it takes a few seconds for sound to resume.

### 4. SAMPLE RATE CONVERTER BUTTON

Use this button to change the sample rate of the input signal via Cary Audio TruBit™ upsampling technology. Each time the button is pressed, the sample-rate will increase as follows:

BYPASS (44.1) ---> 48 ---> 88.2 ---> 96 -->176.4 ---> 192 ---> 352.8 /384---> 705.6/768 kHz ---> DSD64 ---> DSD128 ---> DSD256

### 5. CINEMA BYPASS

Press to activate signal pass-thru (deactivating volume control) if connected to a surround sound processor. For Line Inputs 3 & 4 only.

### 6. BLUETOOTH INPUT BUTTON

Press this button to select the program source of connected/paired BLUETOOTH source.

### 7. USB INPUT BUTTON

Press this button to select the PC or MAC computer connected to the digital input jack labeled USB.

# CONTROLS AND DISPLAYS

---

## 8. COAXIAL 1 INPUT BUTTON

Press this button to select the program source connected to the digital input jack labeled COAXIAL 1.

## 9. COAXIAL 2 INPUT BUTTON

Press this button to select the program source connected to the digital input jack labeled COAXIAL 2.

## 10. OPTICAL TOSLINK INPUT BUTTON

Press this button to select the program source connected to the digital input jack labeled Optical. For digital signals over 96kHz it is usually best to use the coaxial, AES/EBU or USB input. Many Toslink cables do not transfer signals above 96 kHz.

## 11. AES/EBU INPUT BUTTON

Press this button to select the program source connected to the digital input jack labeled AES/EBU.

## 12. ANALOG LINE LEVEL INPUTS 1 THRU 4

Line 1 (RCA Single-ended), Line 2 (XLR Balanced), Line 3 (RCA Single-ended w/CINEMA BYPASS), Line 4 (XLR Balanced w/CINEMA BYPASS).

## 13. ALPHANUMERIC DISPLAY WINDOW

This twenty-character display provides a wide range of information concerning the operation of the SI-300.2d.

## 14. VOLUME CONTROL

Turn knob to adjust the output volume level.

## 15. VU METERS

Displays the power output in wattage into an 8 ohm load.

# CONTROLS AND DISPLAYS

## REAR PANEL

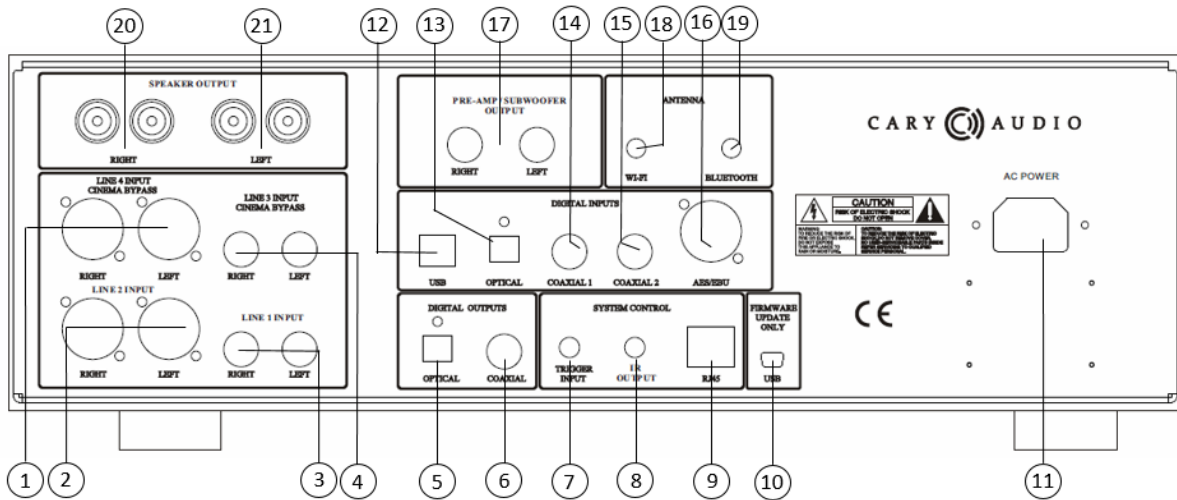

### 1. LINE 4 ANALOG INPUT JACK (XLR BALANCED) W/CINEMA BYPASS

For connecting an XLR balanced source, or the front main Right & Left outputs of a surround sound processor.

### 2. LINE 2 ANALOG INPUT JACK (XLR BALANCED)

For connecting an XLR balanced source.

### 3. LINE 1 ANALOG INPUT JACK (RCA SINGLE-ENDED)

For connecting an RCA source.

### 4. LINE 3 ANALOG INPUT JACK (RCA SINGLE-ENDED) W/CINEMA BYPASS

For connecting an RCA source, or the front main Right & Left outputs of a surround sound processor.

### 5. DIGITAL OUTPUT JACK (TOSLINK)

44.1 kHz – 192 kHz digital data output.

### 6. DIGITAL OUTPUT JACK (COAXIAL)

44.1 kHz - 192 kHz digital data output.

### 7. DC TRIGGER INPUT TERMINALS

Connection of devices that have DC + 12V output for remote turn-on/off of the SI-300.2d.

### 8. IR INPUT

Connection of external IR sensors.

### 9. ETHERNET RJ45 JACK

For network system control.

### 10. MINI USB FIRMWARE

For internal service use only

### 11. POWER INPUT (AC IN)

Connect to AC mains using the included power supply cord.

# CONTROLS AND DISPLAYS

---

## 12. DIGITAL INPUT JACK (USB)

44.1 kHz -384kHz and DSD 64, 128, 256 digital data input to this jack.

## 13. DIGITAL INPUT JACK (OPTICAL)

44.1 kHz -192kHz digital data input to this jack.

## 14. DIGITAL INPUT JACK (COAXIAL 1)

44.1 kHz -192kHz digital data input to this jack.

## 15. DIGITAL INPUT JACK (COAXIAL 2)

44.1 kHz -192kHz digital data input to this jack.

## 16. DIGITAL INPUT JACK (AES/EBU)

44.1 kHz -192kHz digital data input to this jack.

## 17. PREAMPLIFIER/SUBWOOFER OUTPUTS

For connection to an external amplifier or a subwoofer with built-in amplifier. These outputs are variable (NOT fixed).

## 18. Wi-Fi ANTENNA

Wireless network connection for system control.

## 19. BLUETOOTH ANTENNA

44.1 kHz CSR aptX® lossless wireless digital audio receive port.

## 20. SPEAKER CONNECTOR (RIGHT CHANNEL)

Connect your right channel speaker's positive (Red +) and negative (Black -) to the corresponding (red +) and (Black -) connectors on the SI-300.2d. It is recommended to use a quality Spade or Banana connector. **NOTE:** Make sure the system power is off before making any connections.

## 21. SPEAKER CONNECTOR (LEFT CHANNEL)

Connect your left channel speaker's positive (Red +) and negative (Black -) to the corresponding (red +) and (Black -) connectors on the SI-300.2d. It is recommended to use a quality Spade or Banana connector. **NOTE:** Make sure the system power is off before making any connections.

# CONTROLS AND DISPLAYS

## REMOTE CONTROL

This section explains how to use the remote control to set up and operate the SI-300.2d.

1. **POWER:** Use to turn the power on and off.
2. **INPUT KEYS:** Use for Wi-Fi security code input.
3. **BALANCE:** Use to adjust the speaker balance right or left.
4. **VOLUME -/+:** Decrease or increase volume for the analog outputs.
5. **NAVIGATION CONTROL:** Use to navigate the menu structure
6. **BRIGHT:** Use to select the player to display various brightness levels or turn the display off.
7. **DIGITAL INPUT SOURCE SELECTOR:** Use to select the desired digital input source.
8. **ANALOG INPUT SOURCE SELECTOR:** Use to select the desired analog input source.
9. **MUTE:** Use to mute sound. Press again to resume sound.
10. **MODE:** Use this button to increase the output by +6db for use when using low output sources. When engaged a "D" will appear next to the volume.
11. **MENU:** Use to display the menu system of the SI-300.2d.
12. **SRC:** Sample Rate Converter. Press to select a TruBit™ upsamplerate.

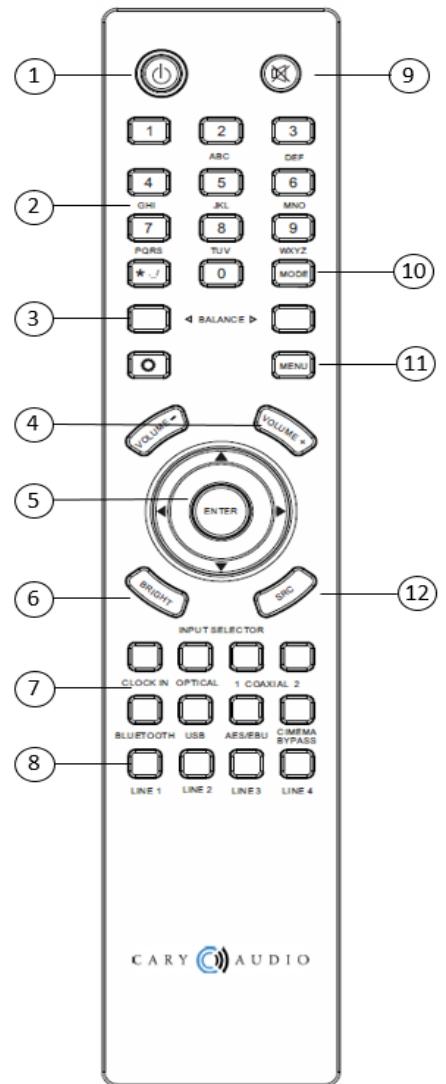

## APP CONTROL FOR iOS AND ANDROID (FUTURE)

The SI-300.2d has a custom App for iOS and Android devices that can be downloaded free of charge from Apple iTunes or the Google/Android Apps Marketplace. Utilizing the SI-300.2d Ethernet port or built-in Wi-Fi connection, these Apps can control all functions of the SI-300.2d once the SI-300.2d has established a network connection. For information on connecting to a network, please be sure to read the **Ethernet and Wi-Fi Setup** section of the manual.

# MENU OPERATION

---

## SETUP MENU OVERVIEW

1. Press "**MENU**" on the hand held remote.
2. The display screen will show the Menu Mode as follows:

SETUP MENU

Volume Setup

IR Controls

Ethernet

Wi-Fi

EXIT

3. Using the "**UP**" or "**DOWN**" arrow keys on the remote, *highlight* your selection and *press Enter*.
4. Make your selections for each mode and *press Enter* to back out to the Setup Menu.
5. When finished, *select EXIT* and *press Enter* to leave the Setup Menu.

## PROCEDURES FOR NAVIGATING ETHERNET AND WI-FI SUB MENUS

Select Ethernet or Wi-Fi and press enter.

1. A \* will denote the active sub menu topic with a selection choice below it.

Enable \*

No

2. To change the default selection of a sub menu topic, press enter. Notice the \* will move down to indicate the active selection which will blink.

### STEP 1

Enable:

No (blink) \*

3. As it blinks, use the up/down keys on the remote to change the available choices and press enter to make your selection. Note that all selection choices are not visible and you must use the up/down keys to scroll all available choices.

### STEP 2

Enable:

Yes (blink) \*

## MENU OPERATION

---

4. Once a selection for the sub menu topic is made, the \* will move back up to the sub menu topic like so, showing your selection beneath it.

Enable: \*

Yes

5. Use the up/down keys on the remote to go to the next sub menu topic and repeat above steps for all Ethernet and Wi-Fi sub menu topics.

IP Assign: \*

DHCP

6. For alphanumeric entries, use the keypad. Although the letters do not appear on the remote, they function like a telephone keypad as follows; Key 2 (2abcABC), key 3 (3defDEF), key 4 (4ghiGHI), key 5 (5jklIJKL), key 6 (6mnoMNO), key 7 (7pqrsPQRS), key 8 (8tuvTUV), key 9 (9wxyzWXYZ).

### SETUP MENU – EXPANDED VIEW AND FUNCTIONS

## Volume Setup

1. **Master Volume or Independent Volume**
  - If you wish to volume match different sources set to **Independent**, otherwise set to **Master**.

## IR Controls

1. **Front**
  - Select **Front** if there is only a need to control the SI-300.2d via the hand held remote and have line of sight to the front panel of the unit.
2. **Rear**
  - Select **Rear** if there are IR sensors connected to the rear of the SI-300.2d for when the unit is installed inside a rack or out of line of sight of the remote.
3. **Both**
  - Select **Both** if both Front and Rear conditions apply and to be able to have flexibility of controlling either way or simultaneously.



# MENU OPERATION

---

## NETWORK ETHERNET AND WI-FI SETUP (FROM DAC)

The SI-300.2d comes with both an Ethernet Port and built-in Wi-Fi for connection to your network for controlling the SI-300.2d via network control systems as well as iOS and Android Apps.

## Ethernet

1. **Enable;**

**Yes** or **No**

**Yes** is the default setting.

2. **IP Assign:**  
**DHCP** or **Static**

Select **DHCP** for an IP address to be assigned automatically to the SI-300.2d (most common method).

**(If Static is selected, follow steps a & b)**

- a) **Assign IP:**

-----

Enter your desired IP address using the hand held remote control.

- b) **Connect:**

**Yes**

After entering your desired IP address, *select* **YES**.

3. **Status:**  
**Connected**

**Connected** will display once successfully connected to your network. If the connection was unsuccessful **No Connection** will be displayed. If this happens, make sure your Ethernet cable is plugged into the SI-300.2d and your router/network is setup for **DHCP**. After confirming, make sure the above selections are correct and jump to Reset Connection below.

4. **Reset Connection:**  
**Yes** or **No**

If your connection was unsuccessful, or you just need to reset the network connection for any reason, select **YES**.

## MENU OPERATION

---

5. **Local Port:**  
Displays the assigned local port.
6. **IP Address:**  
Displays the assigned IP address.
7. **Net Mask Addr:**  
Displays the assigned net mask address.
8. **Gateway Addr:**  
Displays the assigned gateway address.
9. **MAC Addr:**  
Displays the assigned MAC address.
10. **Return**  
Select return to the Ethernet Setup menu.

## Wi-Fi

1. **Enable;**  
**Yes** or **No**  
**No** is the default setting for Wi-Fi. *Select YES.*
2. **IP Assign:**  
**DHCP** or **Static**  
Select **DHCP** for an IP address to be assigned automatically to the SI-300.2d (most common method).

**(If Static is selected, follow steps a thru d. Otherwise skip to number 3)**

- a) **Scan Wi-Fi Networks:**  
**Yes**  
*Select Yes to display available Wi-Fi networks. Choose the network you wish to connect to and select it by pressing **Enter** on the hand held remote.*

## MENU OPERATION

---

### b) Enter Wi-Fi Key:

-----

If the chosen network is secured, enter the security key code of your Wi-Fi network using the hand held remote.

Use the number keys on the hand held remote as follows for all alphanumeric characters.

**Note:** For spaces, press the "0" key for a blank space. For special characters, press the \*./\_ key.



### c) Assign IP: -----

Enter your desired IP address using the hand held remote control.

### d) Connect:

## Yes

After successfully entering the network security key, *select* **YES** to connect.

## 3. Scan Wi-Fi Networks:

## Yes

*Select* **Yes** to display available Wi-Fi networks. Choose the network you wish to connect to and *select it by pressing* **Enter** on the hand held remote.

## 4. Enter Wi-Fi Key: -----

If the chosen network is secured, enter the security key code of your Wi-Fi network using the hand held remote.

## 5. Connect:

## Yes

After successfully entering the network security key, *select* **YES** to connect.

## 6. Status:

## Connected

**Connected** will display once successfully connected to your network. If the connection was unsuccessful **No Connection** will be displayed. If this happens, make sure your Wi-Fi is enabled on the SI-300.2d and your router/network is setup for **DHCP**. After confirming, make sure the above selections are correct and jump to Reset Connection below.

## MENU OPERATION

---

### 7. **Reset Connection:**

**Yes** or **No**

If your connection was unsuccessful, or you just need to reset the network connection for any reason, select **YES**.

### 8. **Local Port:**

Displays the assigned local port.

### 9. **IP Address:**

Displays the assigned IP address.

### 10. **Net Mask Addr:**

Displays the assigned net mask address.

### 11. **Gateway Addr:**

Displays the assigned gateway address.

### 12. **MAC Addr:**

Displays the assigned MAC address.

### 13. **Return**

Select return to the Ethernet Setup menu.

## **Exit**

4. *Highlight* **EXIT** and *press* **ENTER** on the hand held remote to *leave the* **SETUP MENU** and return to normal operation.

# MENU OPERATION

---

## NETWORK WI-FI SETUP (FROM APP)

Once you have downloaded the SI-300.2d control app for your iOS or Android device, please follow the step below.

By default, Ethernet is enabled for the SI-300.2d. Simply plug an Ethernet cable into the Ethernet port on the SI-300.2d. If you have trouble connecting the app, be sure to confirm the SI-300.2d's Ethernet is connected using the previous instructions under "NETWORK ETHERNET AND WI-FI SETUP". Make sure the Ethernet cable is firmly connected and the SI-300.2d shows "Connected" under Ethernet settings. If not, try resetting the Ethernet and repeat steps.

### Wi-Fi Setup

To Setup Wi-Fi from the app you MUST first connect the SI-300.2d to Ethernet and establish a connection from the steps above.

(This step assumes you have NOT setup the Wi-Fi from the SI-300.2d itself).

1. *Open* the **app** and it will automatically search for Ethernet connected SI-300.2d's.
2. *Click* on the **Settings icon** *in the app* then *select* **Network**.
3. *Select* **Wi-Fi/Wireless**.
4. From the **Wi-Fi AP** *dropdown box*, *select* your wireless network.
5. **Enter** your **Security Key** and *select* **Save**.
6. Next, *click* the red **Reset Network** button.
7. Confirm the Wi-Fi is connected in the SI-300.2d's Setup Menu.
1. You should now be able to unplug your Ethernet connection from the SI-300.2d with all connectivity now being Wi-Fi.

# MAINTENANCE FUNCTIONS

---

## MAINTENANCE FUNCTIONS

### Checking the Software Versions, Date and Serial Number of the SI-300.2d.

#### From hand held remote

- Enter "**8,5,2,1**" quickly *on the hand held remote*. This will show the software version, date and serial number of the unit for a few seconds, then default to normal operation.

#### From App

- Click on the **Settings icon** *in the app* then select **About**.

### Resetting the SI-300.2d.

#### From hand held remote

- Enter "**8,5,2,5**" quickly *on the hand held remote*. This will reset the unit.

#### From App

- Click on the **Settings icon** *in the app* then select **Reset**.

**Note:** If the corresponding information fails to engage or display when using the hand held remote, re-enter the sequence faster and closer to the unit.

# GENERAL OPERATION

---

## POWER ON/OFF

Press the power button on the front panel or via the IR remote. The blue ring around the power button will blink for several seconds while the SI-300.2d warms up and initializes. Once the blue ring steadily glows and you hear a click, the SI-300.2d is ready for use. When powering off, it is recommended to first turn the volume down to a low level, then press the power button once again. The SI-300.2d will power on to the same input and volume setting last used. This is why it is recommended to turn the volume down prior to powering off as to not damage the unit, speakers, or your hearing.

## SPEAKER CONNECTIONS

The SI-300.d is equipped with high quality 5-way speaker binding posts. Simply connect your speakers positive + and negative – connections to the corresponding positive + and negative – connectors on the rear of the SI-300.2d. Do not make speaker connections when the unit is powered on and always start at the speaker end first. We recommend a high quality speaker cable with high quality spade or banana connectors.

## SOURCE CONNECTIONS

Connect all sources to the SI-300.2d with quality RCA or XLR cables for analog sources and quality USB, coaxial, optical, and AES/EBU cables for digital sources. It is not recommended to connect or disconnect any source(s) to the SI-300.d while powered on. If your source(s) have a variable output volume it is typically best to adjust them to 100% output. For sources that have a very high output (above 2.0 volts) you may want to use the "Mode" button on the IR remote so that the letter "D" is NOT display next to the volume range on the SI-300.2d front panel. For sources of less than or equal to 2.0v you may want to experiment with the IR remote "Mode" function to display the letter "D" next to the volume range.

## SWITCHING INPUTS

To switch inputs, simply press the desired input on the SI-300.2d front panel, on the IR remote control, or via the Android or iOS control apps available for free. When switching inputs, the SI-300.2d will soft mute the output circuit for a few seconds as a precautionary measure. It is also recommended to turn the volume down to a reasonable level when switching inputs.

## MUTING THE SOUND

You may completely mute the sound of the SI-300.2d either via the front panel display or the IR remote control. When mute is engaged the word "Mute" will display on the front panel in place of the volume range. Press the Mute button again or adjust the volume up to disengage mute. Once disengaged it will take a few seconds for the sound to resume.

## VU METERS

A handsome and fun feature of the SI-300.2d are the VU Meters. They show the power output in wattage into a nominal 8 ohm load. The needles will move in accordance to the amount of power output. The higher the output the more the needles will move.

**Caution:** The SI-300.2d is a very powerful amplifier. Please be mindful of this as to not damage your speakers or your hearing for the sake of watching the meters dance!

# DIGITAL INPUT OPERATION

## USING THE ANALOG INPUTS

The Analog inputs include both RCA single-end and XLR balanced connections; **LINE 1, LINE 2, LINE 3, LINE 4.**

- LINE 1 = RCA connection
- LINE 2 = XLR connection
- LINE 3 = RCA connection with Cinema Bypass function.
- LINE 4 = XLR connection with Cinema Bypass function.

1. **Select** the desired input by **pressing LINE 1, LINE 2, LINE 3, or LINE 4** button. Once selected, the SI-300.2d will confirm your selection by display the input name in LARGE print for a few seconds, and then will default to the following display.

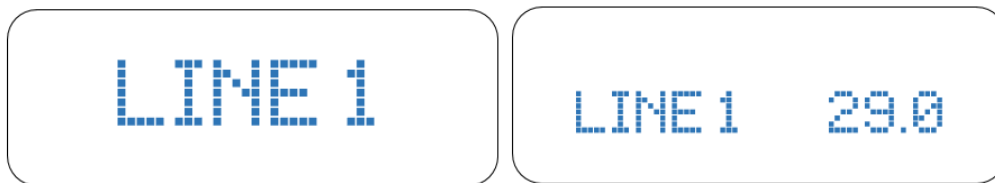

## CINEMA BYPASS FUNCTION

The Cinema Bypass function is used when combining both a traditional 2 channel stereo system and a multi-channel surround sound system into one system. To do this, simply connect the surround sound processor main front Left & Right channels outputs to either LINE 3 or LINE 4 on the SI-300.2d. (The remaining outputs of the surround sound processor will connect directly to the corresponding multi-channel amplifier(s) inputs). When Cinema Bypass is engaged on the SI-300.2d the LINE 3 or LINE 4 input will pass directly to the SI-300.2d amplifier stage bypassing the SI-300.2d's volume control. Therefore, once engaged the surround sound processor will control all volume for all channels even though the SI-300.2d is acting as the amplifier for the main front Left & Right stereo channels.

1. *Connect* the **surround sound processor main front Left & Right channels outputs** to either LINE 3 or LINE 4. If the surround sound processor uses RCA outputs use LINE 3. If the surround sound processor uses XLR outputs use LINE 4.
2. *Select* Input **LINE 3 or LINE 4.**
3. Once your input is selected, *Press* **CINEMA BYPASS** on the front panel or via the IR remote.  
**NOTE:** A caution message will appear on the SI-300.2d display panel prompting you to be sure the volume is turned down on your surround sound processor as once engaged the volume will be controlled by the surround sound processor.
4. *After checking the surround sound processor volume, Press* the **CINEMA BYPASS** button again on the front panel or *Enter* on the IR remote to engage.
5. To *deselect* **CINEMA BYPASS** mode, *simply select another input on the SI-300.d.*



# DIGITAL INPUT OPERATION

## USING THE SPDIF INPUTS

The SPDIF inputs include; **COAXIAL 1, COAXIAL 2, OPTICAL, and AES/EBU.**

1. **Select** the desired input by **pressing COAXIAL 1, COAXIAL 2, AES/EBU or OPTICAL** button. Once selected, the SI-300.2d will confirm your selection by display the input name in LARGE print for a few seconds, and then will default to the following display.

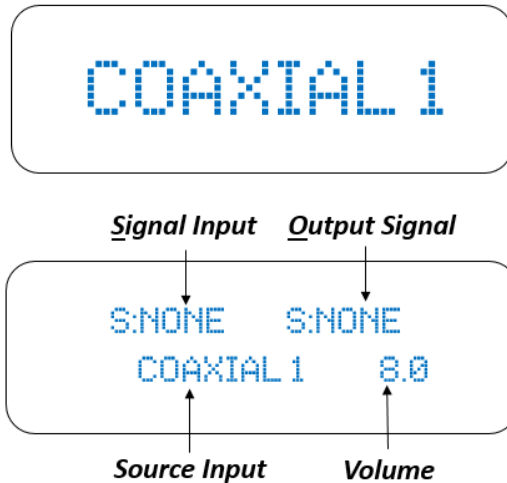

2. Initiate playback of the corresponding SPDIF source. Once playback begins the Signal Input will appear in the display window. The Output Signal will display based on its setting. For example, if the Signal Input is 44.1K and the TruBit™ Sample Rate Converter is set to 192K the display will appear as follows: *(Please read the TruBit™ Sample Rate Converter section of this manual for more on its operation).*

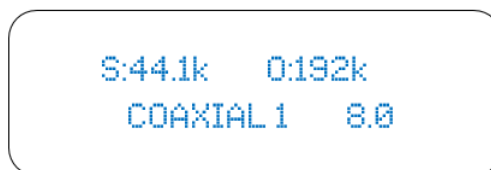

### NOTES:

- Digital input signals can be outputted in both digital format (via the COAXIAL and TOSLINK DIGITAL OUTPUTS) and analog format (RCA and Balanced XLR) simultaneously.
- Only linear PCM signals with a sampling frequency of 44.1kHz, 48kHz, 88.2kHz, 96kHz, 176.4kHz or 192kHz can be played over the SPDIF inputs. Do not input any digital signal other than linear pulse code modulation (PCM) signals (CD-ROM, Dolby Digital, DTS signals, etc.). Doing so will generate output noise that could damage the speakers.

# USB OPERATION

---

## USB REQUIREMENTS

The following are minimum required specifications for using with the SI-300.2d USB port. If your computer does not meet these requirements, you will experience lagging of audio and possible freezing of your computer when attempting to operate the SI-300.2d.

### WINDOWS

- Microsoft Windows XP (32bit), Microsoft Windows Vista (32 or 64 bit), Microsoft Windows 7 (32 or 64 bit), Microsoft Windows 8 (32 or 64 bit), Microsoft Windows 8.1 (32 or 64 bit), Microsoft Windows 10 (32 or 64 bit)
- Available USB 2.0 Port (High speed for USB2.0)
- ASIO/KS/WASAPI/Direct sound drivers for Windows XP to 10

### MACINTOSH

- NO driver is needed for MAC OS version 10.6.4 and above.

## PC DRIVER INSTALLATION

To use the SI-300.2d USB port on a Windows based PC, you **MUST** install the provided driver which is downloadable from The SI-300.2d product page on the Cary Audio website. We advise that users read all instructions carefully before installing and following all instructions during the installation process.

### Installing the PC Driver:

- (1) Download the CARY XMOS USBAUDIO V3.34.0 (or later) USB Driver from the Cary Audio SI-300.2d product page.
- (2) Unzip/extract the Driver folder and save to your desktop.
- (3) Connect a USB cable from the computer to the USB input of the SI-300.2d.
- (4) Power on the SI-300.2d. Wait until power button blue ring stops flashing, then select the USB input.
- (5) Open the driver folder you saved to your desktop and double click the Setup.exe.
- (6) Follow the on-screen installation instructions.
- (7) Click "Finish" when complete.

## MACINTOSH USB AUDIO SETUP

Start the setting on System Preferences Panel on MACINTOSH:

- (1) Power on the SI-300.2d and connect your USB cable from the unit to your MAC.
- (2) Open the System Preferences panel on your MAC.
- (3) Select "SOUND" icon.
- (4) Select "OUTPUT."
- (5) Select "**xCore USB Audio 2.0" Output**".
- (6) Close the System Preferences Panel.

# USB OPERATION

---

## USB AUDIO PLAYBACK

To playback music via the USB input and a connected computer, it is necessary to use a "media player" such as JRiver, Foobar, etc. The USB input is capable of extremely high resolution audio, up to 32 bit/ 384kHz PCM, or DSD up to 256. (iTunes nor Windows Media Player is capable of such resolutions on their own). However, please know your media player software thoroughly to know what its limitations may or may not be as it relates to setup, PCM resolutions, DSD capability and supported file types.

Make sure drivers (PC) have been installed by following the instructions above, under *USB Requirements and Installation*, then do as follows:

- (1) If not already on, make sure the SI-300.2d is turned ON and connected to your computer via a high quality USB cable, and then turn ON your PC or MAC.
  - a. **MAC** - Make sure "**xCore USB Audio 2.0 Output**" is selected in the MAC **Sound Preferences** in the **System Preferences Panel**.
  - b. **Windows PC** - Make sure "**XMOS XS1-U8 MFA** is selected as the **Playback device** under the **Sound preferences** in the Windows **Control Panel**.
- (2) **Select the USB input** by pressing the USB input button on the front panel of the SI-300.2d or pressing the USB button on the hand held remote. "USB" will appear on the display screen.
- (3) Open your media player software audio settings and make sure "**TUSBAudioASIO Driver (ASIO)** is selected as the **Audio or Output Device**. If there is a separate **Audio Output Mode** setting for you media player, select ASIO.
- (4) Playback music through the media player software.

**NOTE:** Some media players have Smartphone and tablet Apps that allow you to control the PC or MAC software via the Smartphone or tablet. Otherwise, all control must be done via the computer.

## USB DSD PLAYBACK

This requires the media player to support native DSD or "DSD over PCM" (DoP). It is recommended to use native DSD for PC (capable up to DSD256) and DoP for MAC (capable up to DoP128). Therefore, it is necessary to check your media player settings to send either DSD or DoP depending on your computer and media player. Upon playback, the display screen of the SI-300.2d will show either DoP64, DoP128 (PC or MAC), or DSD64, DSD128, or DSD256 (PC Only).

For now, DSD playback on MAC is limited to DoP64 and DoP128. You may also need to set the MIDI Audio of the MAC computer to 24 Bit.

- (1) In Applications, *open* the **Utilities** folder.
- (2) *Open* **Audio MIDI Setup**.
- (3) *Select* the **XCore Audio Output** on the left panel.
- (4) Next to Format, *select* the highest supported sample rate in the first dropdown box, and *Select* 2ch-24bit Integer in the second dropdown box

**NOTE:** TruBit™ Upsampling Sample Rate Converter does NOT engage for the USB source. Since USB playback is dependent on media player software of the PC or MAC, you must select any desired upsampling within the chosen media player software itself.

# BLUETOOTH OPERATION

---

CSR aptX® lossless Bluetooth audio is capable of CD quality audio when using an aptX® source device. For more information, please visit CSR's web site at <http://www.csr.com/products/61/aptx-lossless>.

## BLUETOOTH CONNECTION

### Pairing a device with the SI-300.2d

When connecting a Bluetooth device to the unit for the first time, the device is required to be registered to the unit. This process is called "PAIRING." Once pairing is completed, subsequent connection can be made with a couple of easy steps.

### Initial Pairing Steps

- (1) **Select** the **BLUETOOTH** input on the SI-300.2D and the display will show "**Enter Pairing**".
- (2) **Go to** the "**Settings**" of your device and find *Bluetooth settings* and make sure Bluetooth function is **ON** and **search for Bluetooth sources**.
- (3) "**CARY SI-300.2d**" should appear on your device. Once it does, **select it**. After pairing is complete, the display of SI-300.2d will show "**Pairing Successfully**".

**NOTE:** If pairing information is deleted from your device, you will need to perform pairing of that device again in order to connect.

## BLUETOOTH PLAYBACK

Once pairing has successfully been completed, you can easily enjoy music from your portable devices as follows.

- (1) **Select** the **BLUETOOTH** input on the SI-300.2d front panel or on the hand held remote.
- (2) Double check your device Bluetooth setting and make sure "**CARY SI-300.2d**" is selected.
- (3) Begin playback of music on your device, which can include stored music files or music apps, such as Pandora®, Spotify®, iHeart Radio®, etc.
- (4) If you see a "play to" icon;  in your music app, tap it and select "CARY SI-300.2d" to ensure the signal is playing to the SI-300.2d.

To get the most of our *fi™ Bluetooth Implementation* during playback you can utilize our TruBit™ PCM & DSD conversion and upsampling for a superior listening experience of Bluetooth sources.

# TruBit™ UPSAMPLING OPERATION

## PCM TO DSD CONVERSION AND UPSAMPLE RATE CONVERTER FUNCTION

TruBit™ PCM & DSD Upsampling is a powerful upsampling technology used to upsample lower sample rates to higher sample rate and increases the bit depth to 32 bits in the digital domain via a dedicated 128 bit DSP engine prior to analog conversion. This can be very useful in achieving a more enjoyable listening experience. Once a native input signal is changed to a selected higher sample rate, the bit depth will also automatically increase to 32 bits for PCM signals and 1 bit for DSD signals. This also allow for conversion of PCM signals to DSD, or lower DSD rates to higher DSD rates. However, like all-powerful tools, this too should be used prudently. We do not take a blanket "higher is better" approach to upsampling. It is important to experiment with different rates depending on your source or source material. Many times a native rate might be preferred whereas some recordings or files formats might benefit from a higher sampling rate, and so on.

The available selectable sample rates depend on the input signals original sample rate. For example, above 192 kHz the available rate(s) will only be in multiples of either 44.1 kHz or 48 kHz as follows:

### Input signal rates of 44.1 or multiples of:

BYPASS (44.1) ---> 48 ---> 88.2 ---> 96---> 176.4 ---> 192 ---> **352.8**---> **705.6**  
---> DSD64 ---> DSD128 ---> DSD256

### Input signal rates of 48 or multiples of:

BYPASS (44.1) ---> 48 ---> 88.2 ---> 96---> 176.4 ---> 192 ---> **384**--->**768**  
---> DSD64 ---> DSD128 ---> DSD256.

**Pressing** the "**Sample Rate Converter**" *button* on the front panel, or the "**SRC**" button on the hand held remote will cycle through the available sample rates.

- The **BYPASS** mode will pass the input signal rate out in its native rate without any upsampling.
- **When an upsample rate is selected**, the SI-300.2d will upsample all incoming rates lower than the selected sample rate up to the selected sample rate as well as increase the bit depth to 32 bits. Any signals played that are equal to or higher than the selected sample rate will playback unchanged. Each of the SI-300.2d inputs will remember the sample rate as set for that input.

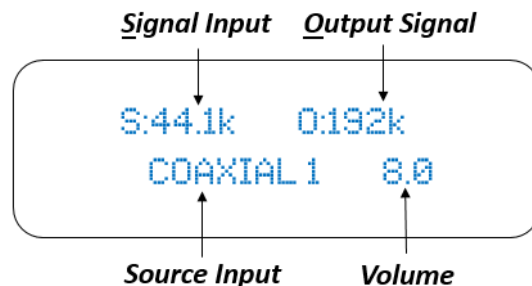

**NOTE:** TruBit™ Upsampling Sample Rate Converter does NOT engage for the USB source. Since USB playback is dependent on media player software of the PC or MAC, you must select any desired upsampling within the chosen media player software itself.

# SPECIFICATIONS

---

The following section describes the SI-300.2d basic specifications. The specifications are subject to change without notice or obligation.

## AMPLIFIER SPECIFICATIONS

**Power Output** 2 x 300 watt RMS into 8  $\Omega$  from 20 Hz - 20 kHz  
2 x 450 watt RMS into 4  $\Omega$  from 20 Hz - 20 kHz

**Circuit Type** Solid State, Class A/B

**Frequency Response (@ 10dB below rated output power)** 10Hz – 50 KHz +/- 0.1dB

**Distortion (SMPTE-1M)** <0.5%

**S/N Ratio** >100dB, "A" weighted

**Protection** Full short circuit, thermal, ultrasonic, RF signal muting & current limiter

## ANALOG INPUTS

**RCA Single Ended** 2 Pair (10k  $\Omega$  Input Impedance), 1 pr. Cinema Bypass  
**XLR (Balanced)** 2 Pair (20k  $\Omega$  Input Impedance), 1 pr. Cinema Bypass

## DIGITAL INPUTS

**USB (Type-B)** XMOS Asynchronous  
Sample Frequency (Fs) from 44.1 kHz to 384 kHz,  
16 bit to 32 bit, DSD 64, DSD 128 and DSD 256(PC Only).

**Coaxial (2)** Sample Frequency  
**Optical (1)** (Fs) from 44.1 kHz to 192 kHz, 16 bit to 24 bit  
**AES/EBU (1)**

**Bluetooth (1)** Sample Frequency (Fs) 44.1 kHz, 16 bit.  
CSR Bluetooth v 4.0 with aptX® low latency audio decoder.

## DIGITAL OUTPUTS

**Coaxial (1)** Sample Frequency  
**Optical (1)** (Fs) from 44.1 kHz to 192 kHz, 16 bit to 24 bit

# SPECIFICATIONS

---

## DIGITAL SPECIFICATIONS

**Master Clock Jitter** Below measurable levels

**Digital Filter** 8x Oversampling Digital Filter

**Digital/Analog Converters** 2 channel AK4490EQ

**Analog Filter** 3<sup>rd</sup> Order Bessel

## GENERAL SPECIFICATIONS

**Control** Trigger input 12VDC x1  
IR control x1

**Communication** Ethernet RJ45 full remote configuration interface  
Wi-Fi 802.11 b/g/n

**Power Input** Configured at factory for either 110-120 or 220-240 VAC,  
50-60 Hz

**Power Consumption** 950 Watts

**Dimensions** 6.0" H x 17.25" W x 18.0" D

**Weight** 52 lbs.

## USB PLAYBACK (PCM & DSD)

**Frequency Range** 2 Hz - 100 kHz

**Signal System** 16, 20, 24, & 32 bit PCM and 1 bit DSD

**Sampling Frequency** 44.1 kHz to 384 kHz PCM and 2.822MHz – 11.288 MHz DSD

**Dynamic Range** 123 dB

**DSD System Clock** Frequency 22.5792 MHz

**Signal-to-Noise Ratio** 112 dB

# SPECIFICATIONS

---

## SPDIF PLAYBACK (PCM) COAXIAL, TOSLINK, AES/EBU

<b>Frequency Range</b>	2 Hz - 100 kHz
<b>Signal System</b>	16, 20, and 24 bit
<b>Sampling Frequency</b>	44.1 kHz to 192 kHz PCM
<b>Dynamic Range</b>	123 dB
<b>System Clock</b>	Frequency 22.5792 MHz
<b>Signal-to-Noise Ratio</b>	112 dB



# SERVICE AND CARE

---

## CARE AND CLEANING

The cabinet housing and front panel of the SI-300.2d may be cleaned with a soft cloth and Windex or a window cleaner. The frequency of cleaning will be governed by how many hours the SI-300.2d is operated and by operating environment cleanliness.

**CAUTION:**

- Do not let any liquids spill into the vents on top of the unit.

## AC POWER FUSE REPLACEMENT

The fuse is located inside the chassis and is not user serviceable. If the unit does not power up, contact an authorized service representative. Never replace the fuse with any other value than a two (2) amp slow blow fuse, 250V for a unit configured to operate at 110V-120V AC. Never use any other value than a one (1) amp slow blow fuse, 250V for a unit configured to operate at 220V-240V AC. The AC Power Cord must be unplugged from the AC Power jack on the back of the unit prior to replacing the fuse. Set the unit Power On/Off switch to the Off position and plug the AC Power cord back into the AC Power jack. Then set the Power On/Off switch to the On position and verify proper operation. Contact Cary Audio for advice if the fuse repeatedly blows.

## FACTORY SERVICE

Careful consideration has been given to the design of your SI-300.2d to keep maintenance problems to a minimum. Any problems or requests for service should be referred to our Customer Service Department at 919-355-0010. DO NOT return the SI-300.2d to the factory without a Return Merchandise Authorization (RMA) number from our online Customer Service Center ([www.caryaudio.com](http://www.caryaudio.com)).

Cary Audio will assume no responsibility if the shipping company refuses to pay for damage due to your improper packing or lack of insurance should the unit be lost or damaged in shipment. Please retain and always use the original shipping carton for shipping the player. Also, Cary Audio reserves the right to return products sent in for service in a new box set at the customer's expense if the original packing material was damaged in the initial shipment, or if it is deemed unsatisfactory to use in return shipping.

## NON-WARRANTY REPAIRS

Cary Audio will provide repair service for its products charging on a time and expense basis. At this time, the standard non-warranty service bench fee is \$125 for the first hour and \$95 per hour thereafter. Parts used for repairs as well as return shipping are additional. This may change and is not a quote for service. Please call us at 919-355-0010 for more information about out-of-warranty service and repair fees.

**CAUTION:**

- Never remove or insert the back panel AC plug when the unit is on or the AC cord is plugged into the wall.

# LIMITED WARRANTY

---

## **Cary Audio Warrants to the Original Purchaser for the Following Cary Audio Products for the Periods Indicated:**

1. Power Amplifiers, Integrated Amplifiers, Surround Sound Processors, and Preamplifiers have a three (3) year parts and labor warranty from the date of the original purchase from Cary Audio.
2. CD or SACD players, DVD players, Music Servers, or Digital Music Centers have an eighteen (18) month parts and labor warranty from the date of the original purchase from Cary Audio.
3. Vacuum tubes, if any are used in the component, are offered a 90-day exchange policy against defects with the exception of the 300B vacuum tube that has a one (1) year exchange policy from the date of the original purchase from Cary Audio.

## **What is Covered and What is Not Covered**

Except as specified below, this warranty covers parts and labor to correct all defects in materials and workmanship. The following are not covered by the warranty:

1. Damage, deterioration, malfunction or failure to meet performance specifications resulting from:
  - a. Accident, acts of nature, misuse, abuse, neglect or unauthorized product modifications
  - b. Improper installation, removal or maintenance, or failure to follow instructions supplied with the product.
  - c. Repair or attempted repair by anyone not authorized by Cary Audio to repair the product.
  - d. Any shipment of the product (claims must be presented to the carrier).
  - e. Any cause other than a product defect.
2. Cleaning, initial set-up, check-ups with no defects found, or charges incurred for installation, removal or reinstallation of the product.
3. Any product, on which the serial number has been defaced, modified or removed.
4. Batteries.
5. Accessories, including but not limited to, batteries, cables, mounting hardware and brackets, cleaning accessories, antenna and detachable power cords.
6. Warranty is void if purchase was made from anyone other than an authorized Cary Audio dealer.

## **Who May Enforce the Warranty?**

This warranty extends to products purchased directly from Cary Audio or an authorized Cary Audio dealer. Purchasers should inquire of the dealer regarding the nature and extent of the dealer's warranty, if any.

To obtain such warranty service, the original purchaser must complete and send in the Warranty Registration Card within 15 days of purchase.

# LIMITED WARRANTY

---

## What Will We Pay For?

We will pay for all labor and material expenses for items covered by the warranty.

## How Can You Get Service?

In the event that the owner needs to return the unit to Cary Audio for service or repair of a possible defect, he must follow the following steps:

1. Create a new account or login to our Customer Service Center ([www.caryaudio.com](http://www.caryaudio.com)) to obtain a Return Merchandise Authorization (RMA) number. Once the account is set up or you have logged in, click on "Open New RMA" to begin entering the information to create an RMA that is needed to return or exchange a product. You will be given an RMA number, which must appear on the label of the box you ship back.
2. Submit a copy of the original sales receipt; blank receipts will not validate the limited warranty for service by Cary Audio. The original sales receipt must contain the following information:
  - a. The authorized Cary Audio dealer's name
  - b. The date of purchase
  - c. The unit's sales price
  - d. The buyer's name and address
  - e. Describe in detail the problem.
  - f. Note the unit's model number and serial number.
3. Deliver by either of these methods:
  - a. With all freight and insurance charges prepaid and in its original packing container or equivalent, ship the component to Cary Audio, 6301 Chapel Hill Road Raleigh, NC 27607.
  - b. Hand-deliver the product to Cary Audio (address noted above) or the nearest authorized service facility.

## Limitation of Implied Warranties

All implied warranties, including warranties of merchantability and fitness for particular purchase, are limited in duration to the length of this warranty.

## Exclusion of Damages

Cary Audio's liability for any defective product is limited to repair or replacement of the product at Cary Audio's option. Cary Audio shall not be liable for damage to other products caused by any defects in Cary Audio products, damages based upon inconvenience or loss of use of the product, or any other damages, whether incidental, consequential, or otherwise.

# LIMITED WARRANTY

---

## **How State Law Relates to the Warranty**

Some states do not allow limitations on how long an implied warranty lasts and/or do not allow the exclusion or limitation of incidental or consequential damages, so the above limitations or exclusions may not apply to you.

This warranty gives you specific legal rights, and you may also have other rights which vary from state to state.

## **International Purchasers (Export Markets)**

Cary Audio warrants its merchandise to purchasers within the United States exclusively for use within the United States. It provides no other warranties, expressed or implied. If you are living outside of the United States, please consult your local dealer or distributor to determine the details of your local warran

**CARY AUDIO DESIGN**

6301 Chapel Hill Road | Raleigh, NC 27607

phone 919-355-0010

fax 919-573-9573

[www.caryaudio.com](http://www.caryaudio.com)