







ART 910-AX
ART 912-AX
ART 915-AX

PROFESSIONAL ACTIVE BLUETOOTH® SPEAKERS

1. SAFETY PRECAUTIONS AND GENERAL INFORMATION

The symbols used in this document give notice of important operating instructions and warnings which must be strictly followed.

	CAUTION	Important operating instructions: explains hazards that could damage a product, including data loss
	WARNING	Important advice concerning the use of dangerous voltages and the potential risk of electric shock, personal injury or death.
	IMPORTANT NOTES	Helpful and relevant information about the topic
	SUPPORTS, TROLLEYS AND CARTS	Information about the use of supports, trolleys and carts. Reminds to move with extreme caution and never tilt.
	WASTE DISPOSAL	This symbol indicates that this product should not be disposed with your household waste, according to the WEEE directive (2012/19/EU) and your national law.

IMPORTANT NOTES

This manual contains important information about the correct and safe use of the device. Before connecting and using this product, please read this instruction manual carefully and keep it on hand for future reference. The manual is to be considered an integral part of this product and must accompany it when it changes ownership as a reference for correct installation and use as well as for the safety precautions. RCF S.p.A. will not assume any responsibility for the incorrect installation and / or use of this product.

SAFETY PRECAUTIONS

1. All the precautions, in particular the safety ones, must be read with special attention, as they provide important information.

2. Power supply from mains

- The mains voltage is sufficiently high to involve a risk of electrocution; install and connect this product before plugging it in.
- Before powering up, make sure that all the connections have been made correctly and the voltage of your mains corresponds to the voltage shown on the rating plate on the unit, if not, please contact your RCF dealer.
- The metallic parts of the unit are earthed through the power cable. An apparatus with CLASS I construction shall be connected to a mains socket outlet with a protective earthing connection.
- Protect the power cable from damage; make sure it is positioned in a way that it cannot be stepped on or crushed by objects.
- To prevent the risk of electric shock, never open this product: there are no parts inside that the user needs to access.
- Be careful: in the case of a product supplied by manufacturer only with POWERCON connectors and without a power cord, jointly to POWERCON connectors type NAC3FCA (power-in) and NAC3FCB (power-out), the following power cords compliant to national standard shall be used:
 - EU: cord type H05VV-F 3G 3x2.5 mm² - Standard IEC 60227-1
 - JP: cord type VCTF 3x2 mm²; 15Amp/120V~ - Standard JIS C3306
 - US: cord type SJT/SJTO 3x14 AWG; 15Amp/125V~ - Standard ANSI/UL 62

3. Make sure that no objects or liquids can get into this product, as this may cause a short circuit. This apparatus shall not be exposed to dripping or splashing. No objects filled with liquid, such as vases, shall be placed on this apparatus. No naked sources (such as lighted candles) should be placed on this apparatus.

4. Never attempt to carry out any operations, modifications or repairs that are not expressly described in this manual. Contact your authorized service centre or qualified personnel should any of the following occur:

- **The product does not function (or functions in an anomalous way).**
- **The power cable has been damaged.**

- **Objects or liquids have got in the unit.**
- **The product has been subject to a heavy impact.**

5. If this product is not used for a long period, disconnect the power cable.

6. If this product begins emitting any strange odours or smoke, switch it off immediately and disconnect the power cable.

7. Do not connect this product to any equipment or accessories not foreseen.

For suspended installation, only use the dedicated anchoring points and do not try to hang this product by using elements that are unsuitable or not specific for this purpose. Also check the suitability of the support surface to which the product is anchored (wall, ceiling, structure, etc.), and the components used for attachment (screw anchors, screws, brackets not supplied by RCF etc.), which must guarantee the security of the system / installation over time, also considering, for example, the mechanical vibrations normally generated by transducers.

To prevent the risk of falling equipment, do not stack multiple units of this product unless this possibility is specified in the user manual.

8. RCF S.p.A. strongly recommends this product is only installed by professional qualified installers (or specialised firms) who can ensure correct installation and certify it according to the regulations in force. The entire audio system must comply with the current standards and regulations regarding electrical systems.

9. Supports, trolleys and carts.



The equipment should be only used on supports, trolleys and carts, where necessary, that are recommended by the manufacturer. The equipment / support / trolley / cart assembly must be moved with extreme caution. Sudden stops, excessive pushing force and uneven floors may cause the assembly to overturn. Never tilt the assembly.

10. There are numerous mechanical and electrical factors to be considered when installing a professional audio system (in addition to those which are strictly acoustic, such as sound pressure, angles of coverage, frequency response, etc.).

11. Hearing loss.

Exposure to high sound levels can cause permanent hearing loss. The acoustic pressure level that leads to hearing loss is different from person to person and depends on the duration of exposure. To prevent potentially dangerous exposure to high levels of acoustic pressure, anyone who is exposed to these levels should use adequate protection devices. When a transducer capable of producing high sound levels is being used, it is therefore necessary to wear ear plugs or protective earphones. See the manual technical specifications to know the maximum sound pressure level.

OPERATING PRECAUTIONS

- Place this product far from any heat sources and always ensure an adequate air circulation around it.
- Do not overload this product for a long time.
- Never force the control elements (keys, knobs, etc.).
- Do not use solvents, alcohol, benzene or other volatile substances for cleaning the external parts of this product.

IMPORTANT NOTES

To prevent the occurrence of noise on line signal cables, use screened cables only and avoid putting them close to:

- **Equipment that produces high-intensity electromagnetic fields**
- **Power cables**
- **Loudspeaker lines**



WARNING! CAUTION! To prevent the risk of fire or electric shock, never expose this product to rain or humidity.



WARNING! To prevent electric shock hazard, do not connect to mains power supply while grille is removed



WARNING! to reduce the risk of electric shock, do not disassemble this product unless you are qualified. Refer servicing to qualified service personnel.

CORRECT DISPOSAL OF THIS PRODUCT



This product should be handed over to an authorized collection site for recycling waste electrical and electronic equipment (EEE). Improper handling of this type of waste could have a possible negative impact on the environment and human health due to potentially hazardous substances that are generally associated with EEE. At the same time, your cooperation in the correct disposal of this product will contribute to the effective usage of natural resources. For more information about where you can drop off your waste equipment for recycling, please contact your local city office, waste authority or your household waste disposal service.

CARE AND MAINTENANCE

To ensure a long-life service, this product should be used following these advices:

- If the product is intended to be set up outdoors, be sure it is under cover and protected to rain and moisture.
 - If the product needs to be used in a cold environment, slowly warm up the voice coils by sending a low-level signal for about 15 minutes before sending high-power signals.
 - Always use a dry cloth to clean the exterior surfaces of the speaker and always do it when the power is turned off.
-



CAUTION: to avoid damaging the exterior finishes do not use cleaning solvents or abrasives.



WARNING! CAUTION! For powered speakers, do cleaning only when the power is turned off.

RCF S.p.A. reserves the right to make changes without prior notice to rectify any errors and / or omissions.

Always refer to the latest version of the manual on www.rcf.it.

2. DESCRIPTION

THE ART 9 AX SERIES

ART 9 AX speakers are masterfully engineered to deliver stellar audio performance and versatility for intensive audio applications. The combination of a 1.75" compression driver, a high quality woofer, two-channel 2100W amplifier, and the constant directivity True Resistive Waveguide produces coherent 100° x 60° coverage for the listening area with a clear and distortion-free sound.

Merging RCF proprietary FIRPHASE and Bass Motion Control (BMC) DSP processing, perfectly tuned for each model, audiences will experience absolute clarity and deep, powerful bass response. The ART 9 AX speakers combine powerful and high-performance amplified speakers, with a digital audio processor for maximum flexibility. Several operating modes are possible, with the speaker alone or in combination with other speakers. Audio can also be streamed to the speakers, along with remote control, via BLUETOOTH®.

All the available functions and parameters are accessible from the onboard color display via a capacitive touch screen and an encoder, as well as from a dedicated app for iOS and Android .

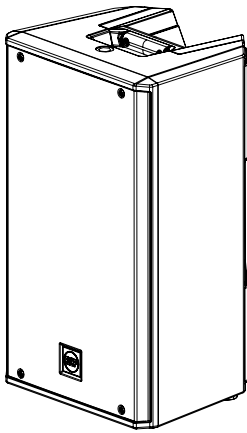

ART 910-AX

2100 Watt
10" Woofer - 2,5" v.c.
1.75" Compression Driver
15.8 kg / 34.83 lbs

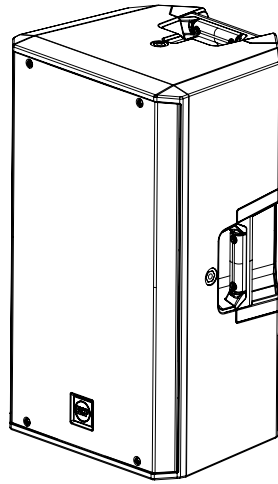

ART 912-AX

2100 Watt
12" Woofer - 2,5" v.c.
1.75" Compression Driver
19 kg / 41.89 lbs

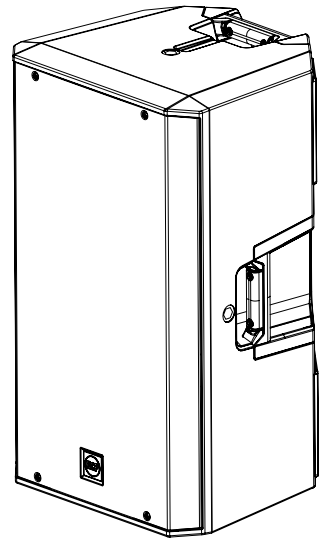

ART 915-AX

2100 Watt
15" Woofer - 2.5" v.c.
1.75" Compression Driver
22 kg / 48.5 lbs

3. REAR PANEL FEATURES AND CONTROLS

- 1 MIC/LINE INPUTS 1/L and 2/R** Two inputs with COMBO connector. Balanced XLR for microphone and line inputs, balanced TRS JACK for line inputs. Microphone inputs are equipped with independently switchable 48V phantom power for condenser or electret microphone use. More details are available on ART 9 AX Reference Guide.
- 2 MIX OUT / IN 1 LINK** is a balanced XLR male multifunction output. When the MIX OUT / IN 1 LINK BUTTON is in the raised position, the output is assigned to the digital section MIX OUT, which can be set in several modes. When the MIX OUT / IN 1 LINK BUTTON key is pressed, the output connector becomes the "input 1 Link Out", which is a direct physical connection with input 1; this allows you to connect an additional speaker by feeding it with the same signal present on input 1.
- 3 AUX IN 3/4** 3.5mm mini-jack connector, auxiliary input that allows the connection of unbalanced stereo external sources.
- 4 SERVICE** Micro-USB port used exclusively for firmware updates.
- 5 VOLUME - RESUME / EDIT ENCODER** When the touch screen is in standby status or displays the MIXER page, the encoder works as the general volume of the speaker. When in standby, pressing the encoder reactivates the touch-screen, showing the MIXER page. At this point, the encoder is assigned to the general volume and you have the option of varying other parameters selecting them via the touch display.
- 6 DISPLAY** The 2.4" display with capacitive touch, combined with the encoder, allows you to access and control all speaker functions. A parameter is selected by touching it on the touch screen and modified by rotating the encoder. More information is available on ART 9 AX Reference Guide downloadable on the product page on www.rcf.it.
- 7 MIX OUT / IN 1 LINK BUTTON** It switches the XLR male output function (see point n°2 - MIX OUT / IN 1 LINK).
- 8 POWER MAIN SWITCH** The power switch turns the AC power ON and OFF.
- 9 FUSE CARRIER** Mains fuse housing.
- 10 STANDARD 3-PRONG IEC SOCKET** Power connection.

 **WARNING! CAUTION! Loudspeaker connections should be only made by qualified and experienced personnel having the technical know-how or enough specific instructions (to ensure that connections are made correctly) in order to prevent any electrical danger.**

To prevent any risk of electric shock, do not connect loudspeakers when the amplifier is switched on.

Before turning the system on, check all connections and make sure there are no accidental short circuits.

The entire sound system shall be designed and installed in compliance with the current local laws and regulations regarding electrical systems.

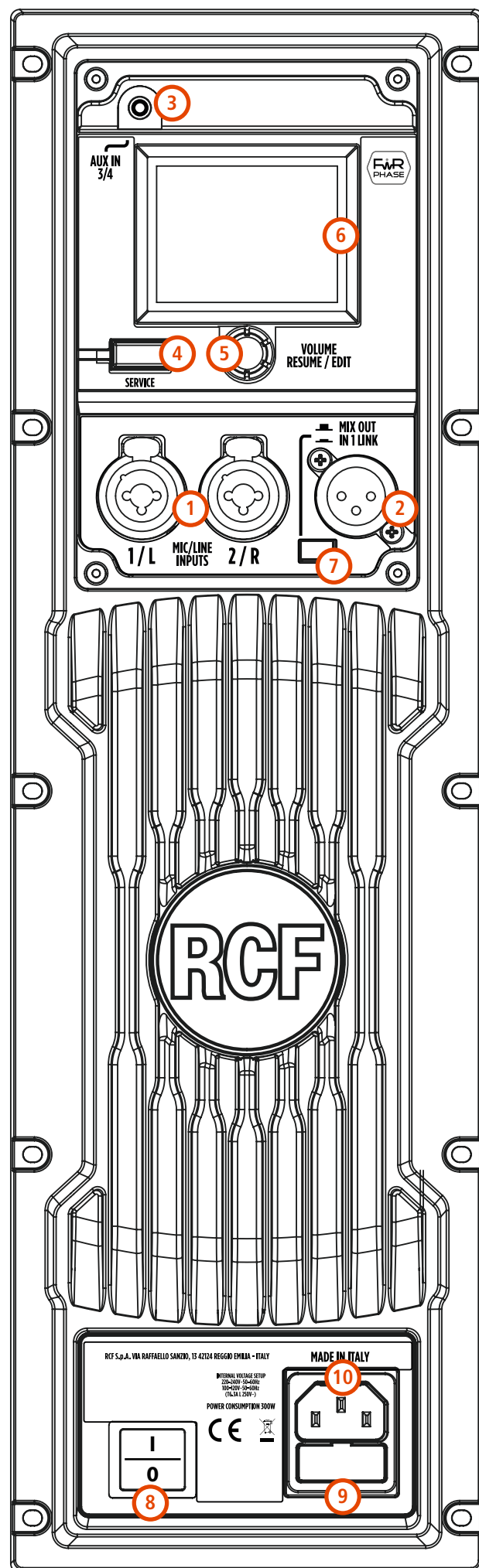

4. MAIN FEATURES

MIXER (HOME) PAGE

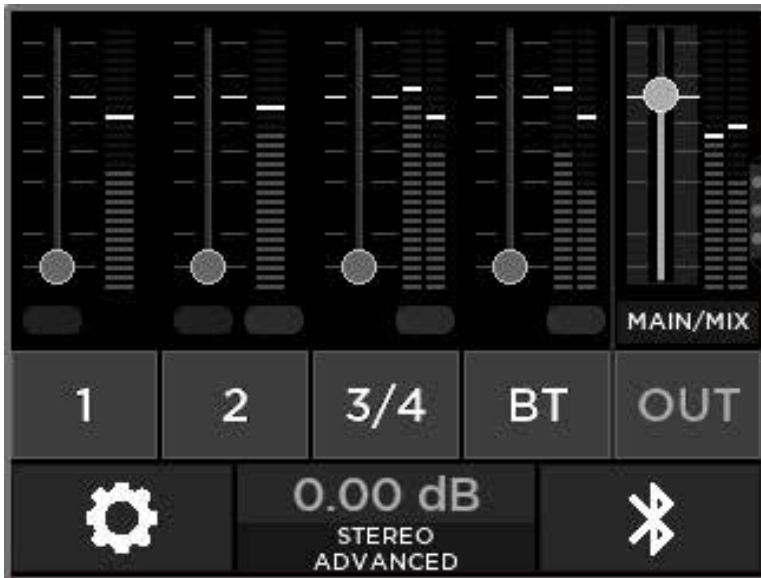

This is the MIXER main screen of the ART 9 AX Control Display.

The MAIN / MIX level is controlled by default with the rotary encoder and its level is shown in dB in the lower/center section of the screen. To set input levels (1, 2, 3/4, BT), touch the corresponding virtual fader and rotate the encoder.

For a detailed description of the editable parameters, refer to the Reference Guide downloadable from the product page on www.rcf.it.

BLUETOOTH® PAGE

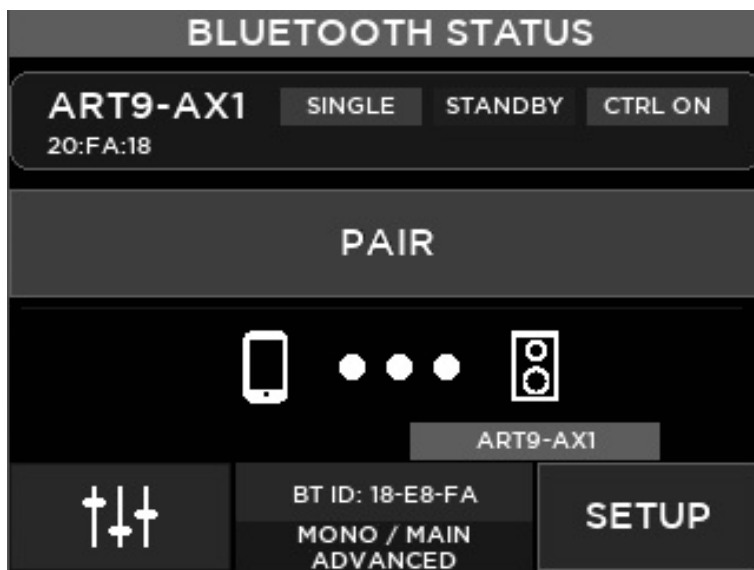

On the smartphone, Bluetooth® list:

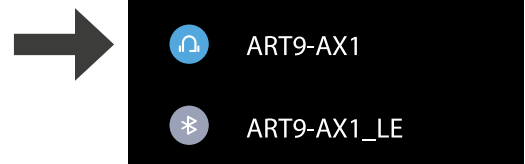

To connect the LiveRemote app running on an iOS or Android device, launch the app; then, from within the app, go to DEVICES lower tab, launch a SCAN and connect the ART 9-AX speaker. To connect the speaker for audio streaming, go to the Bluetooth® page and touch the PAIR button; on the device you want to connect to, go to Bluetooth® settings page and select the audio device labelled ART9-AX1. Please notice that some smartphone operating system may show two entries, take care in avoiding a connection to the non-audio one (ending in _LE), see example above. The speaker Bluetooth® name may be different; ART9-AX1 is the default one and can be modified. The SETUP button opens the control page for additional Bluetooth® configuration parameters. Connection status and mode are shown in the upper strip on the display. For more information on the various Bluetooth® configurations, refer to the Reference Guide downloadable from the product page on www.rcf.it.

5. CONNECTIONS

The connectors must be wired according to the standards specified by the AES (Audio Engineering Society).

MALE XLR CONNECTOR Balanced wiring

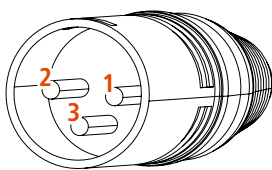

FEMALE XLR CONNECTOR Balanced wiring

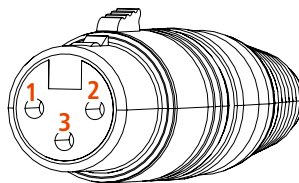

PIN 1 = GROUND (SHIELD)
PIN 2 = HOT (+)
PIN 3 = COLD (-)

6.3 mm TS CONNECTOR Unbalanced mono wiring

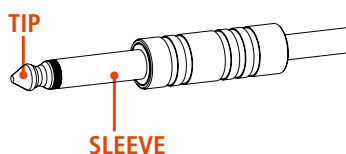

6.3 mm TRS CONNECTOR Balanced mono wiring

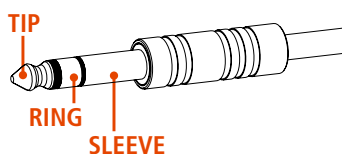

SLEEVE = GROUND (SHIELD)
TIP = HOT (+)
RING = COLD (-)

3.5 mm MINI JACK CONNECTOR Stereo wiring

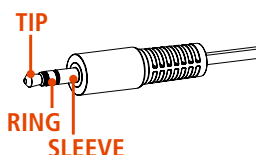

SLEEVE = GROUND (SHIELD)
TIP = LEFT SIGNAL
RING = RIGHT SIGNAL

BEFORE CONNECTING THE SPEAKER

On the rear panel you will find all the controls, signal and power inputs. At first verify the voltage label applied to the rear panel (115 Volt or 230 Volt). The label indicates the right voltage. If you read a wrong voltage on the label or if you can't find the label at all, please call your vendor or authorized RCF SERVICE CENTRE before connecting the speaker. This fast check will avoid any damage.

In case of need of changing the voltage please call your vendor or authorized RCF SERVICE CENTRE. This operation requires the replacement of the fuse value and is reserved to an RCF SERVICE CENTRE.

BEFORE TURNING ON THE SPEAKER

You can now connect the power supply cable and the signal cable. Before turning on the speaker make sure the volume control is at the minimum level (even on the mixer output). It is important that the mixer is already ON before turning on the speaker. This will avoid damages to the speaker and noisy "bumps" due to turning on parts on the audio chain. It is a good practice to always turn on the speakers at last and turning them off immediately after their use. You can now turn ON the speaker and adjust the volume control to a proper level.

PROTECTIONS

ART Series active speakers are equipped with a complete system of protection circuits. The circuit is acting very gently on audio signal, controlling level and maintaining distortion at acceptable level.

VOLTAGE SETUP (RESERVED TO THE RCF SERVICE CENTRE)

200-240 Volt, 50 Hz

100-120 Volt, 60 Hz

(FUSE VALUE T6.3 A L 250V)

6. INSTALLATION

FLOOR CONFIGURATIONS

Several configurations are possible with ART 9 Speakers; they can be placed on the floor or on a stage as main PA or used as stage monitors; they can also be pole mounted on a speaker stand or over a subwoofer.

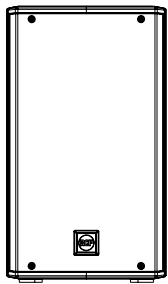

**FLOOR OR STAGE
STANDING**

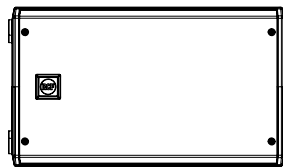

**STAGE
MONITOR**

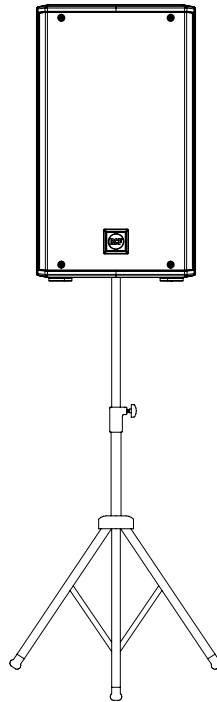

**POLE
MOUNTED**

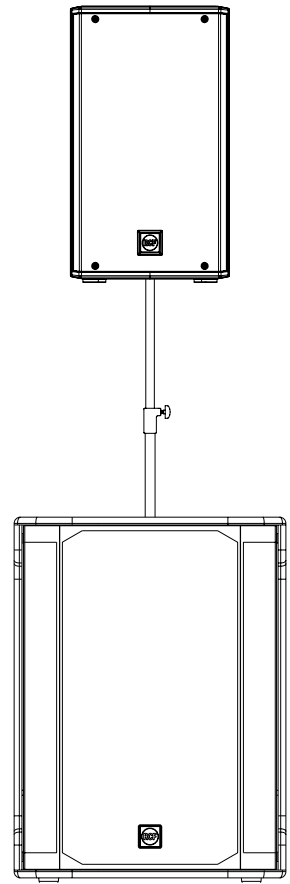

**SUBWOOFER
MOUNTED**

SUSPENDED CONFIGURATIONS

ART 9 Speakers can also be wall mounted or hung with the use of their specific accessories **ART9 H-BR**, **ART9 V-BR** and **ART9 FL-BR**.

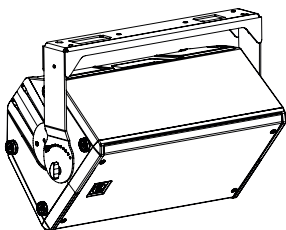

ART9 H-BR

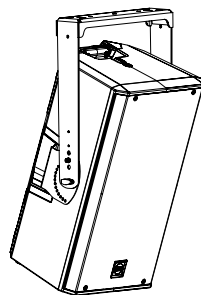

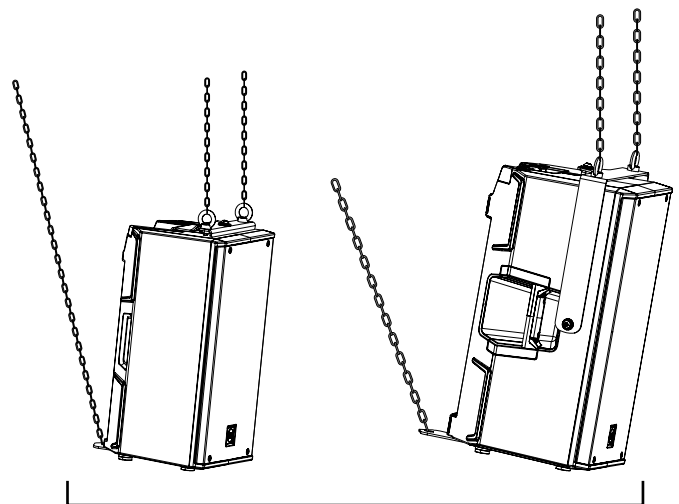

ART9 V-BR



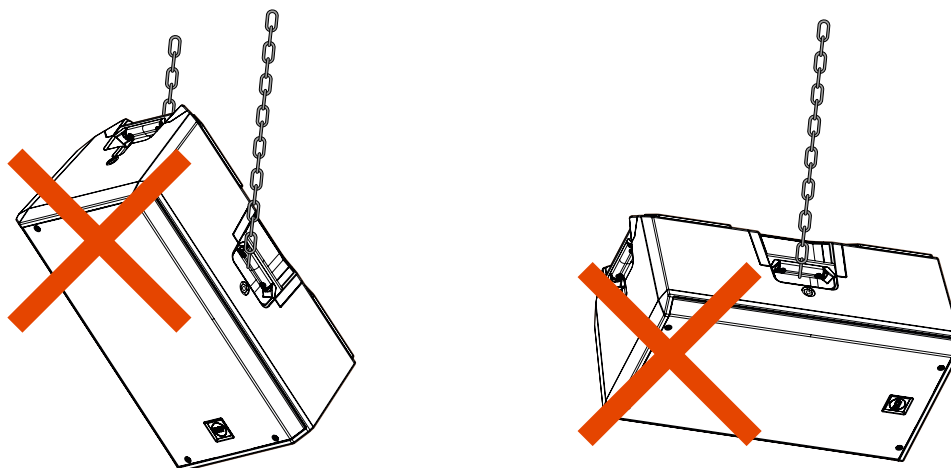



ART9 FL-BR

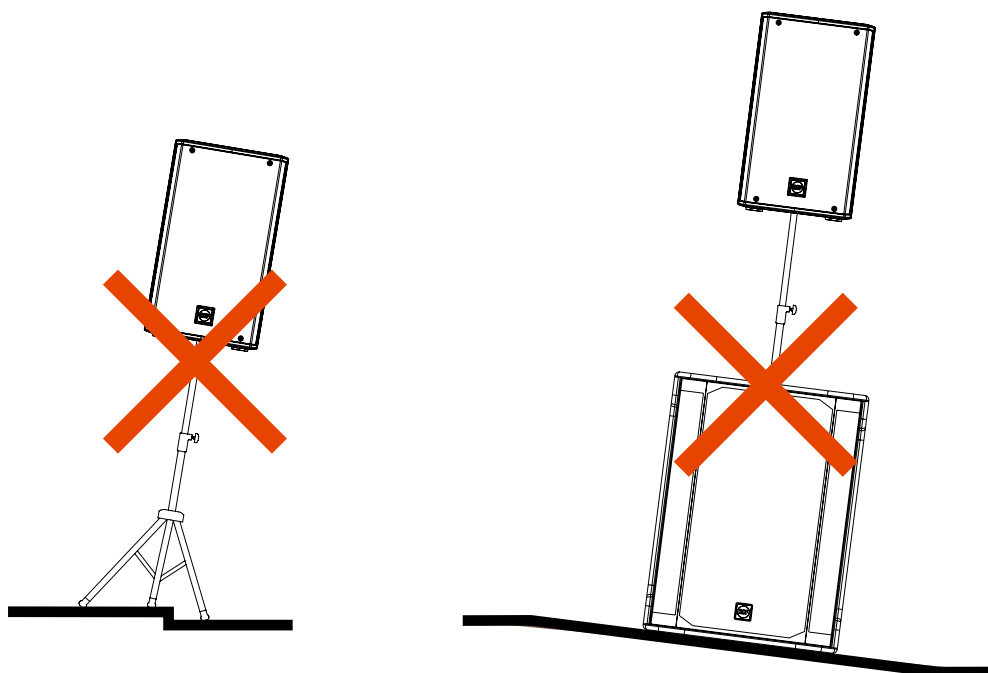

  **WARNING! CAUTION!** Never suspend ART speakers by there handles. Handles are intended for transportation, not for rigging.



  **WARNING! CAUTION!** To use this product with the subwoofer pole-mount, before installing the system, please verify the allowed configurations and the indications regarding the accessories, on the RCF website to avoid any danger and damages to people, animals and objects. In any case, please assure the subwoofer which is holding the speaker is located on an horizontal floor and without inclinations.

  **WARNING! CAUTION!** The use of these speakers with Stand and Pole Mount accessories can be done by qualified and experienced personnel only, trained appropriately on professional systems installations. In any case it's the user's final responsibility to ensure the system safety conditions and avoid any danger or damage to people, animals and objects.

7. TROUBLESHOOTING

THE SPEAKER DOESN'T TURN ON

Make sure the speaker is switched on and connected to an active AC power

THE SPEAKER IS CONNECTED TO AN ACTIVE AC POWER BUT DOESN'T TURN ON

Make sure the power cable is intact and connected correctly.

THE SPEAKER IS ON BUT DOESN'T MAKE ANY SOUND

Check if the signal source is sending correctly and if the signal cables are not damaged.

THE SOUND IS DISTORTED AND THE OVERLOAD LED BLINKS FREQUENTLY

Turn down the output level of the mixer.

THE SOUND IS VERY LOW AND HISSING

The source gain or the output level of the mixer might be too low.

THE SOUND IS HISSING EVEN AT PROPER GAIN AND VOLUME

The source might send a low quality or noisy signal

HUMMING OR BUZZING NOISE

Check out the AC grounding and all the equipments connected to the mixer input including cables and connectors.



WARNING! to reduce the risk of electric shock, do not disassemble this product unless you are qualified. Refer servicing to qualified service personnel.

ART 910-AX DIMENSIONS

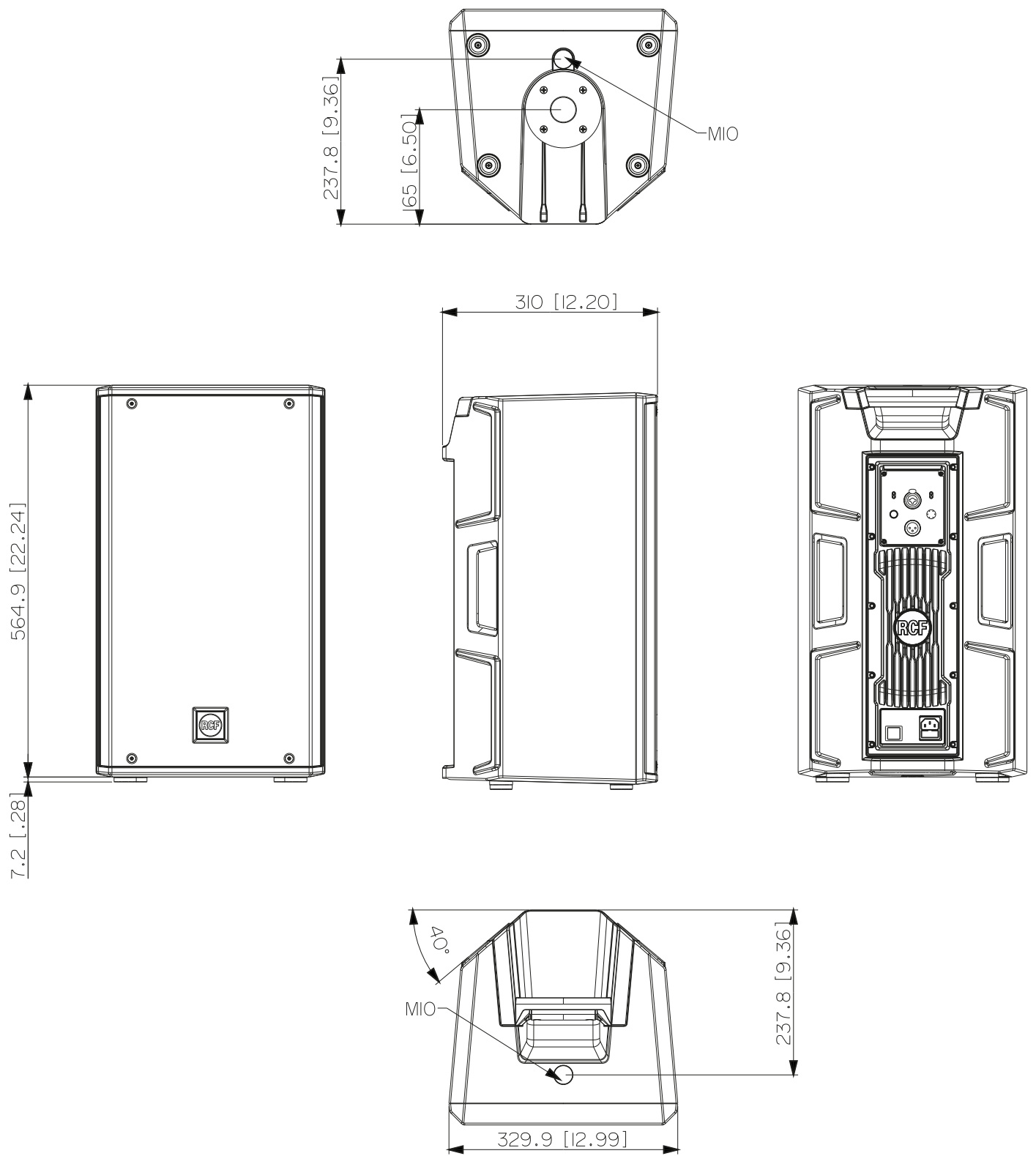

ART 912-AX DIMENSIONS

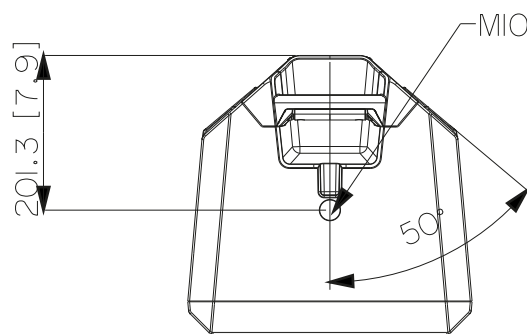
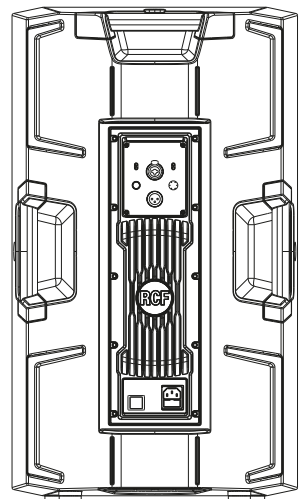
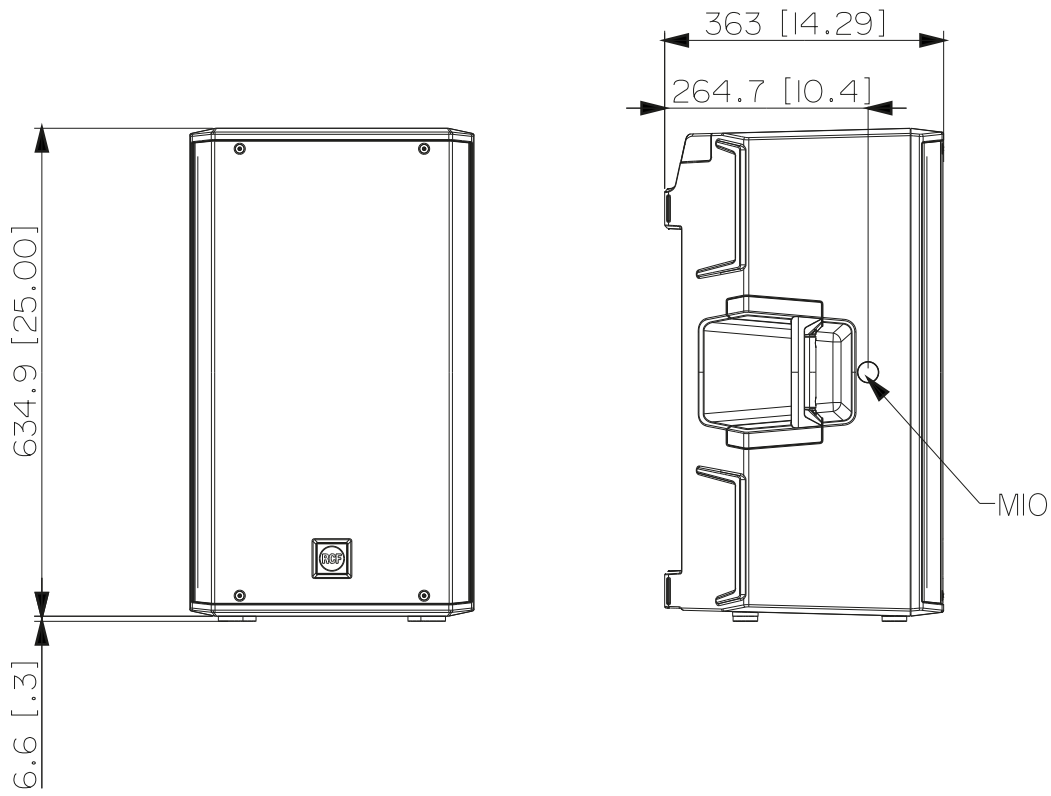
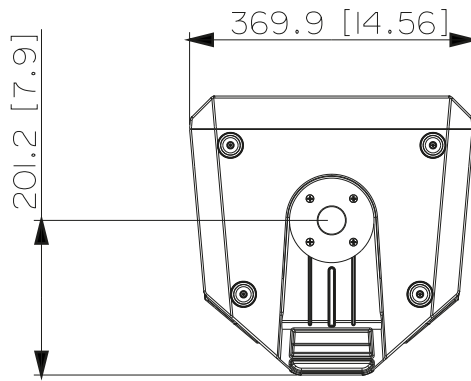

ART 915-AX DIMENSIONS

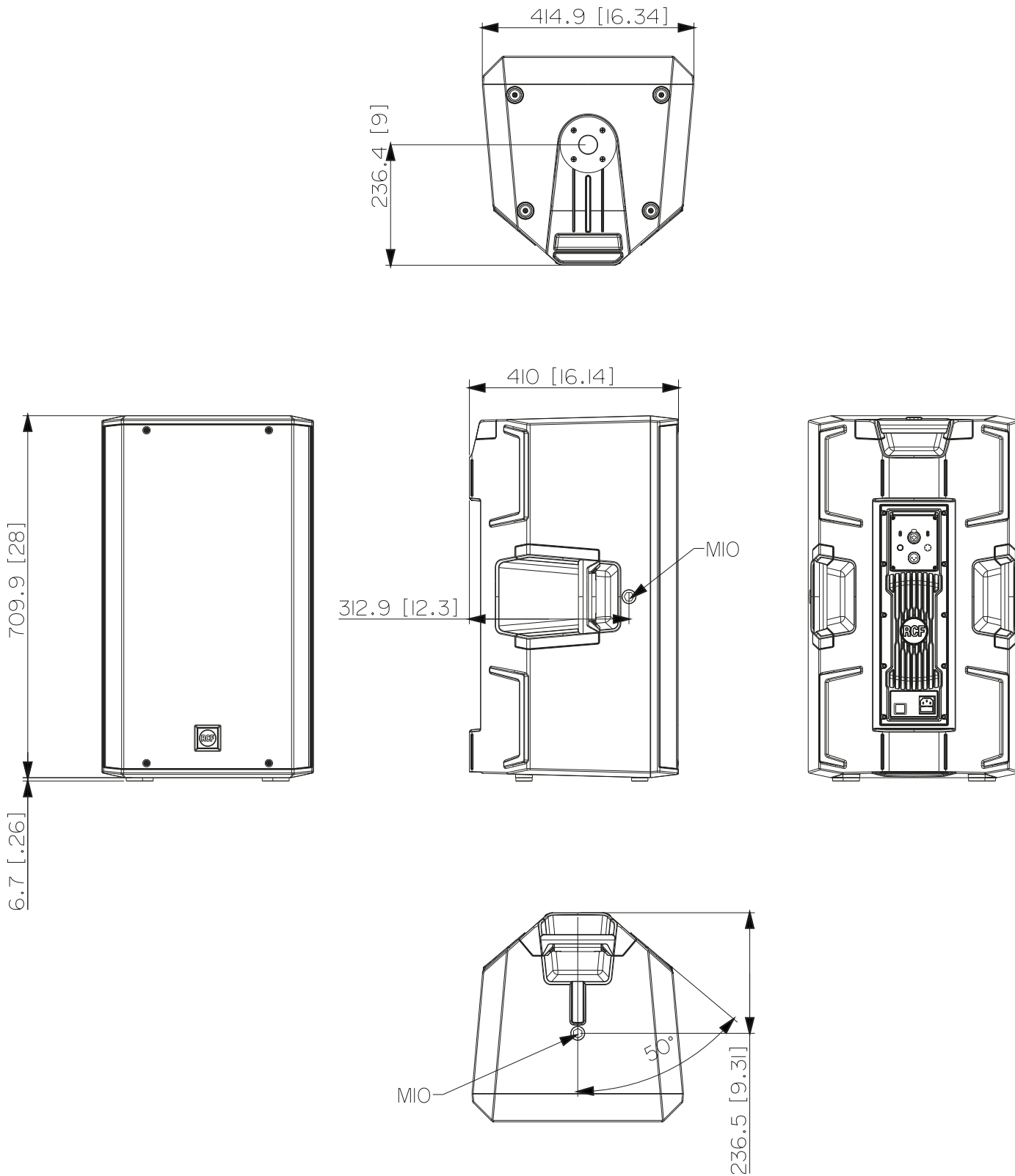

SPECIFICATION

TECHNICAL SPECIFICATIONS		ART 910-AX	ART 912-AX	ART 915-AX
Acoustical specifications	Frequency Response:	50 Hz ÷ 20000 Hz	50 Hz ÷ 20000 Hz	45 Hz ÷ 20000 Hz
	Max SPL @ 1m:	130 dB	130 dB	131 dB
	Horizontal coverage angle:	100°	100°	100°
	Vertical coverage angle:	60°	60°	60°
Transducers	Compression Driver:	1.0", 1.75" v.c	1.0", 1.75" v.c	1.0", 1.75" v.c
	Woofer:	10", 2.5" v.c	12", 2.5" v.c	15", 2.5" v.c
Input/Output section	Input signal:	bal/unbal	bal/unbal	bal/unbal
	Input connectors:	Jack/XLR	Jack/XLR	Jack/XLR
	Output connectors:	XLR	XLR	XLR
	Input sensitivity:	-2 dBu/+4 dBu	-2 dBu/+4 dBu	-2 dBu/+4 dBu
Processor section	Crossover Point:	1800 Hz	1800 Hz	1800 Hz
	Protections:	Thermal, RMS limiter	Thermal, RMS limiter	Thermal, RMS limiter
	Limiter:	Soft limiter	Soft limiter	Soft limiter
	Controls:	Linear, Boost, Stage, Volume	Linear, Boost, Stage, Volume	Linear, Boost, Stage, Volume
Power section	Total Power:	2100 W Peak, 1050 W RMS	2100 W Peak, 1050 W RMS	2100 W Peak, 1050 W RMS
	High frequencies:	700 W Peak, 350 W RMS	700 W Peak, 350 W RMS	700 W Peak, 350 W RMS
	Low frequencies:	1400 W Peak, 700 W RMS	1400 W Peak, 700 W RMS	1400 W Peak, 700 W RMS
	Cooling:	Convection	Convection	Convection
	Connections:	VDE AC socket	VDE AC socket	VDE AC socket
Standard compliance	CE marking:	Yes	Yes	Yes
Physical specifications	Cabinet/Case Material:	PP composite	PP composite	PP composite
	Hardware:	2xM10 (1 Top, 1 Bottom)	3xM10 (1 Top, 2 Sides)	3xM10 (1 Top, 2 Sides)
	Handles:	1 Top	1 Top, 2 Side	1 Top, 2 Side
	Grille:	Steel	Steel	Steel
	Color:	Black	Black	Black
Size	Height:	572 mm / 22.52 inches	642 mm / 25.28 inches	717 mm / 28.23 inches
	Width:	330 mm / 12.99 inches	370 mm / 14.57 inches	415 mm / 16.34 inches
	Depth:	310 mm / 12.2 inches	363 mm / 14.29 inches	410 mm / 16.14 inches
	Weight:	15.8 kg / 34.83 lbs	19 kg / 41.89 lbs	22 kg / 48.5 lbs

